

1981



W A G O N E E R

WAGONER

®

Jeep Wagoneer The Ultimate Wagon.

Welcome to Jeep Wagoneer for 1981. Try as they may, full-size conventional wagons just can't measure up.

Inside, Wagoneer is comfortable, quiet, spacious replete with the conveniences and appointments full-size luxury wagon buyers (or, for that matter, luxury sedan buyers) want.

Outside, Wagoneer is a classic illustration of styling that is tasteful and timeless.

Underneath is the sure-footed security of Jeep's famous 4-wheel drive. It provides more traction, more driver control on road or off, and in any weather than conventional rear-wheel drive, or even front-wheel drive systems. And since the system is engineered by Jeep Corporation, with a rich heritage of 4-wheel drive excellence that goes back more

than 40 years, you can be sure that the system is rugged, reliable and durable.

The tradition of elegance and the engineering sophistication you've come to expect in Jeep Wagoneer has been retained. Plus we have some pleasant surprises for you in the 1981 edition. There is more Wagoneer variety to choose from which means you will find the ultimate wagon is now more affordable. Other engineering advancements, such as new low drag front disc brakes, have made the 1981 Jeep Wagoneer more efficient,† more practical, more sensible for the times we live in.

Right now, America needs a full size wagon with the advantages of 4-wheel drive and it has one...just one...Jeep Wagoneer, the ultimate family wagon. Test drive the elegant Jeep Wagoneer. It could be the last wagon you'll need for the rest of this decade.

† see EPA mileage statement on back cover.



The mark of distinction.



Jeep Wagoneer

For 1981, we've expanded the Wagoneer line to include the Custom model, new Brougham package and the incomparable Wagoneer Limited. The effect is that Wagoneer is now more affordable. So more families can take advantage of the sure-footed security of 4-wheel drive.

Jeep Wagoneer Custom

The standard Wagoneer is the Custom...but it's hardly what you would call "standard". Power steering, new low-drag power front disc brakes, part-time 4WD with free-wheeling front hubs and 4-speed, fully synchronized manual transmission are all standard. The passenger area is richly carpeted and the seats elegantly trimmed in Cara grain vinyl.

The standard 258 CID six-cylinder engine is 90 lbs. leaner this year, for even more spirited performance and practicality.

New standard Goodyear "Viva" radials, a new front air dam and the low drag disc brake design, all combine to reduce Wagoneer's rolling resistance.

If you wish, you can team the standard Six and part-time 4-wheel drive system with the optional automatic transmission which features a lock-up torque converter. Either way the part-time system lets you select 2-wheel drive when you want it for on-road efficiency, or 4-wheel drive when you need it for sure-footed security for the family. Jeep's exclusive Quadra-Trac[®] automatic 4WD is also available.

You can order just about any convenience you want from Wagoneer's generous options and accessories list.



Wagoneer Custom



Wagoneer Limited



Wagoneer Limited

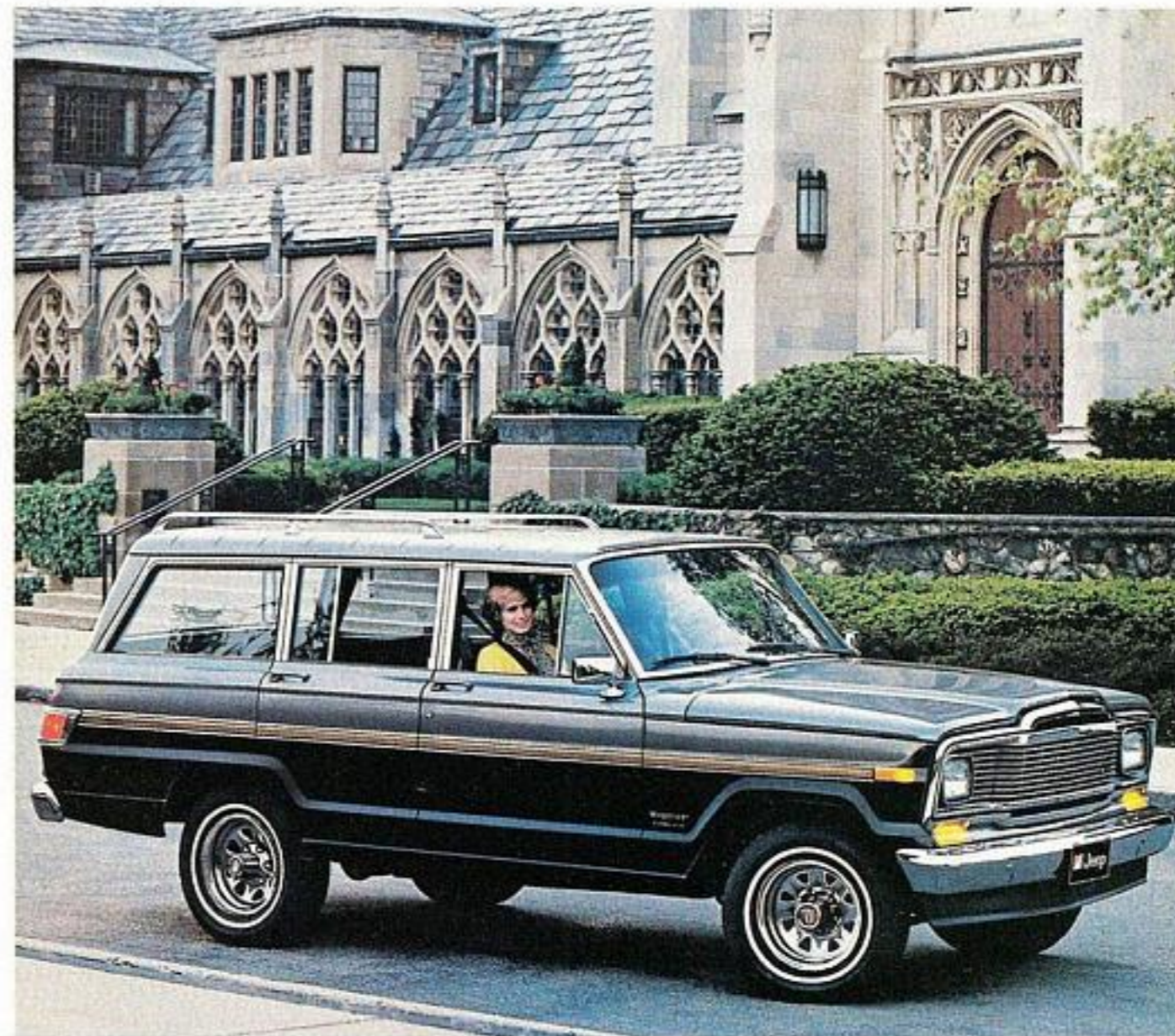

Wagoneer Brougham

Jeep Wagoneer Brougham

The Wagoneer Brougham package is new for '81. It offers everything the Custom includes plus additional trim and convenience items that put it a cut above the Custom Wagoneer ...and way above most other full size wagons.

On the inside, there's luxurious Coventry Check fabric upholstery for the comfortable bench seat or available buckets. Or, if you prefer, Deluxe Grain vinyl. The available colors are black, blue, beige or nutmeg.

Premium door trim panels, soft headliner and woodgrain instrument cluster and horn cover complete the Brougham interior scheme.

Bright door frames, bright quarter window frames, and lower tailgate moldings dress up the Brougham exterior. The bodyside scuff molding with woodgrain insert is both handsome and protective. And the standard Wagoneer "Viva" radials are set off by 15 x 7 chrome styled steel wheels.

On the functional side, the Brougham includes the following features: extra quiet insulation; the Convenience Group (including underhood light, lights-on buzzer and digital clock); the Light Group (including interior cargo light and tailgate switch, a lighted visor vanity mirror, and courtesy, map/dome, glove box and ashtray lights); a roof rack; protective floor mats; and a power tailgate window.

Jeep[®] Wagoneer

Jeep Wagoneer Limited

"Wagoneer Limited" says it all. It is the most completely equipped, elegantly appointed full size American wagon you can own. We've taken care of your family's comfort and convenience down to the last detail. The elegant Wagoneer Limited includes all of the Custom Wagoneer equipment plus bucket seats with leather/cord trim, center armrest and unique door panels (nutmeg or beige); leather wrapped steering wheel; extra thick 22 oz. carpeting in seating area (20 oz. in cargo area w/insulation); retractable cargo area cover; and woodgrain trim on the lower instrument panel.

Outside, the wide woodgrain side and rear treatment is set off with wide moldings; roof rack with woodgrain inserts; bright drip rails; forged 15" x 7" aluminum wheels (4); P225/75R15 Arriva-WSW radial (steel) tires and "Limited" nameplates.

On the functional side there's Quadra-Trac[®] automatic 4WD and automatic transmission; air conditioning; tinted glass; power windows/door locks; power tailgate window; cruise control; tilt steering wheel; AM/FM stereo radio; premium audio system; Convenience Group; Visibility Group; bumper guards & nerf strips; protective floor mats; Extra Quiet Insulation; and power six-way driver's and passenger seats.



Interiors



Wagoneer has taken interior elegance to its highest plateau with the incomparable Limited. The full foam cushioned bucket seats with center armrest are beautifully tailored in genuine leather and corduroy in a choice of beige or new nutmeg. The Cara grain vinyl door trim panels, the full pile carpeting, the soft headliner, the padded instrument panel and visors are all carefully color-keyed. The Brougham package bench or optional bucket seats come in either rich Coventry Check fabric seat trim or Deluxe Grain vinyl in black, blue, beige or nutmeg. Custom Wagoneer bench seats are of Cara vinyl in black, blue or beige.

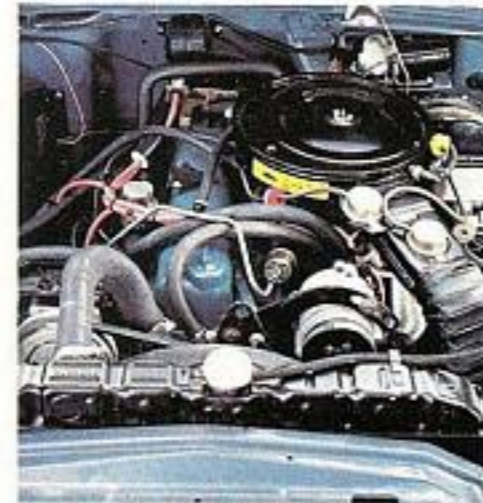
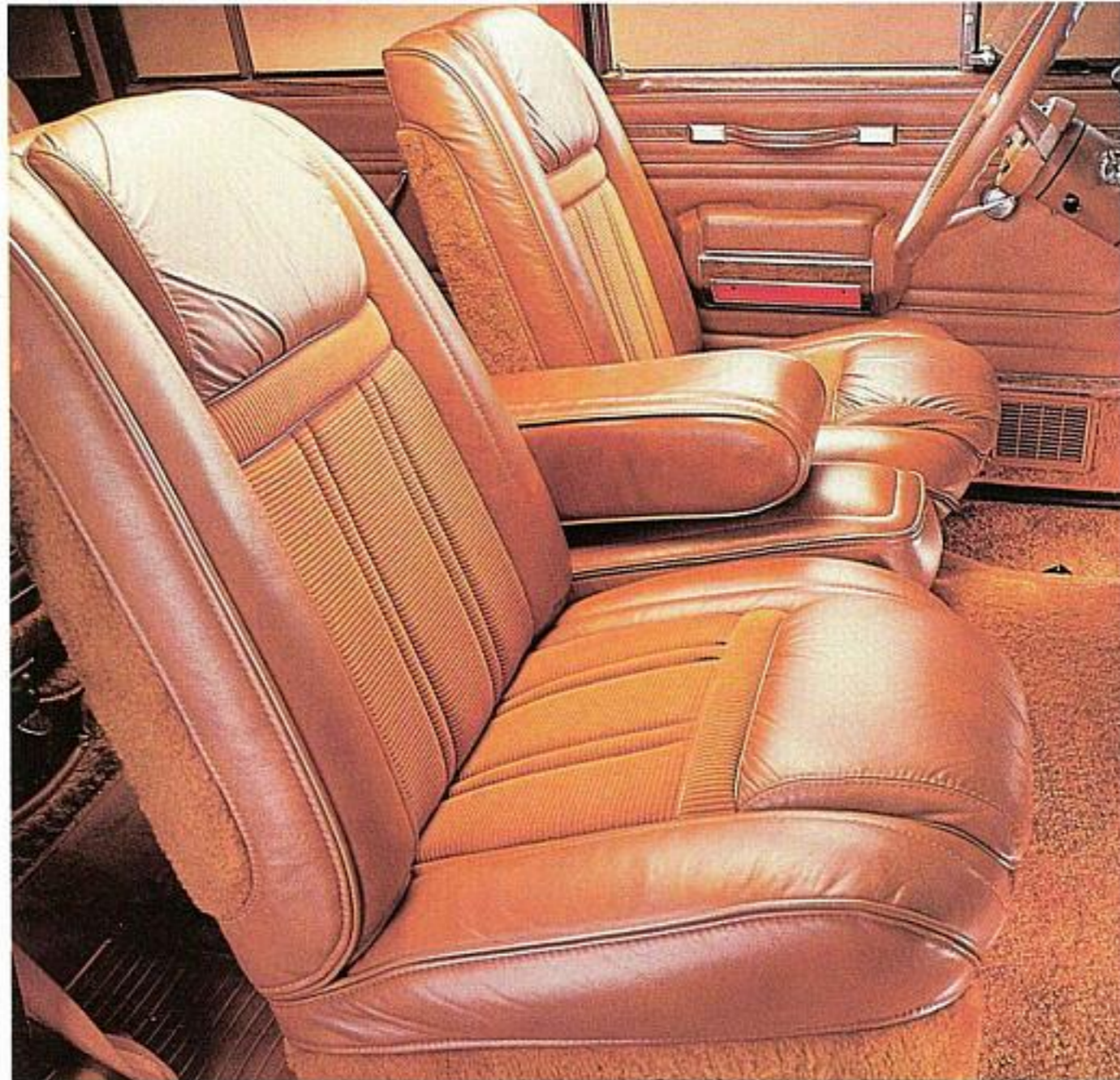

258 CID, Six, 2-barrel



Aluminum wheels



Chrome wheels

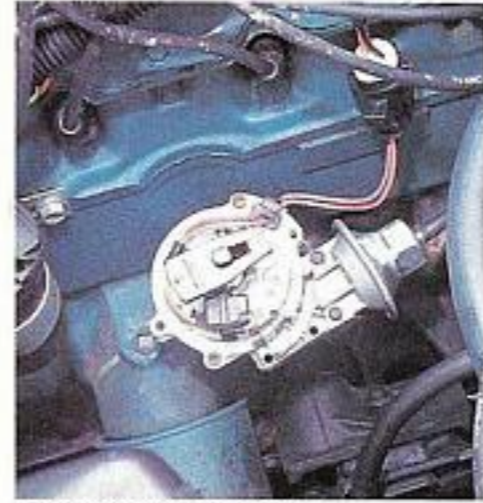

Electronic ignition system



Quartz digital clock



Lighted visor vanity mirror



Power front disc brakes



Dual remote mirrors with swingaway feature



Folding and removable rear seat



Tilt steering wheel

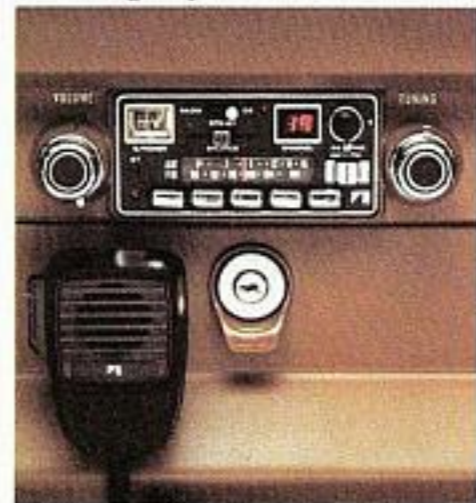

AM/FM/CB stereo



Cruise control

Standard Features & Options

Standard:

- Ash tray—front & rear
- Armrests—front & rear
- Cigar lighter
- Floor covering—carpeting (front & rear seat floor area & wheelhousing)
- Gauges—oil, ammeter, temp., fuel
- Glove box lock
- Heater & defroster
- Padded sun visors
- Washers—electric, and 2-speed electric wipers
- Bumpers—chrome plated aluminum
- Lights—head, parking, backup, tail, stop, directional signal (w/ lane-change detent), side safety marker, 4-way hazard flasher
- Moldings—bright vent window and windshield, with new windshield upper moldings, end cap & drip rails
- Air cleaner—cellulose fiber
- Air dam, front (new)
- Alternator 12-volt, 63-amp
- Battery—12-volt 55-380
- Coolant (engine)—permanent w/Hi-Temp thermostat (50-50 mixture)
- Emission control system
- Engine—258 CID Six
- Exhaust system—single
- Power steering
- Transmission—4-speed, manual with part-time 4WD (Custom); Automatic with Quadra-Trac 4WD (Limited)
- Fuel tank skid plate
- Front stabilizer bar
- Hood release—inside (new)
- Steering column—energy absorbing w/anti-theft ignition, steering and transmission lock
- Tools—jack, screw type, combined wheel wrench and jack handle
- Tires—P225/75R15 Viva fiberglass radials

Options:

- Two-tone paint
- Leather wrapped sports steering wheel (incl. w/Limited)
- Carpeted passenger and cargo areas (incl. w/Limited)
- Scuff molding
- Convenience Group—includes underhood light; lights on buzzer; digital clock (incl. w/Limited & Brougham)

Options (cont'd.)

- Visibility Group—right & left matching remote outside mirrors; intermittent wipers; Halogen headlamps (incl. w/Limited)
- Light Group—includes interior cargo light and tailgate switch; courtesy lights; glove box light; ashtray light; map/dome light; lighted visor vanity mirror (incl. w/Limited & Brougham)
- Air conditioning (incl. w/Limited)
- Tinted glass (incl. w/Limited)
- Rear window defroster
- Inside spare tire mount and cover
- Clear lens fog lamps (incl. w/Limited)
- AM radio and antenna
- AM/FM stereo radio & antenna (incl. w/Limited)
- AM/FM/CB stereo radio
- Premium audio system—includes power amplifier and higher fidelity speakers (incl. w/Limited)
- 360 CID 2-bbl. V-8 (N/A Calif.)
- Part-time 4-wheel drive with free wheeling front hubs
- Heavy duty cooling
- Extra duty suspension package
- Heavy duty shocks front and rear
- Heavy duty 70-amp battery
- Heavy duty 70-amp alternator
- Cold climate group—includes heavy duty battery & alternator; engine block heater
- Bumper guards—front & rear (incl. w/Limited)
- Brush guard
- Protective floor mats (incl. w/Limited & Brougham)
- Snow Boss Package—a complete snow plow installation (hydraulic controls, plow lights, wiring & heavy duty engine & chassis components)
- Trailer Towing—See your Jeep dealer for information about special trailer towing packages & for details on other factory options not included in this listing, & for a select list of dealer installed accessories.



6-way power seat

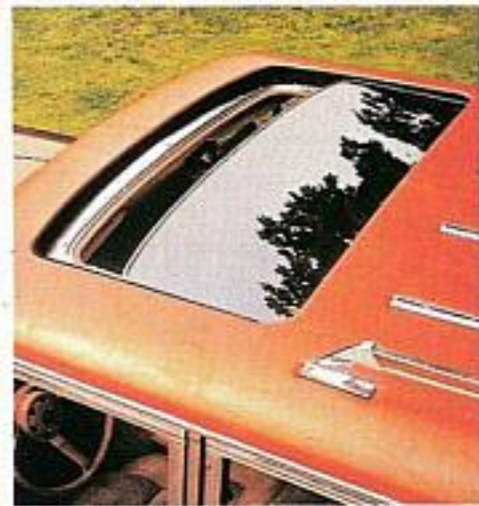

Power moon roof (Limited only)

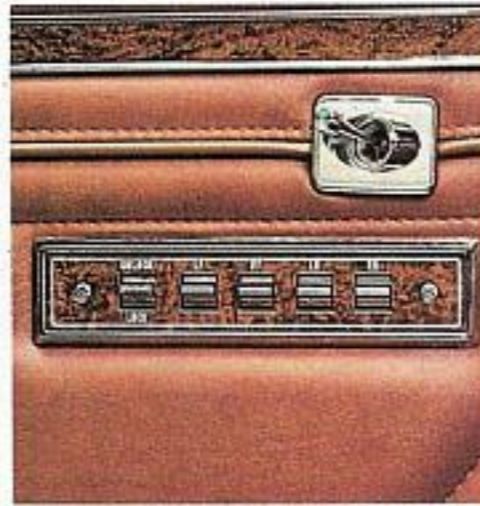

Power windows and door locks



Power tailgate window



Vinyl roof (with moon roof only)



Ski carrier—dealer installed



Cargo area cover



Hidden winch—dealer installed

Jeep
Store

GENUINE JEEP PARTS AND ACCESSORIES ARE AVAILABLE ONLY FROM THE JEEP STORE... YOUR LOCAL JEEP DEALER.

Colors



4WD Systems

Nobody engineers 4-wheel drive systems like Jeep Corporation does, because nobody knows more about 4-wheel drive. 40 years of design innovation in 4WD has taught us how to engineer in toughness and durability. It's also taught us how to make our componentry lighter without sacrificing that toughness. That's increasingly important as we move through the '80s, and as more owners start using their vehicles for conventional driving needs, as well. With Jeep Wagoneer you can select your vehicle two ways: Quadra-Trac automatic 4-wheel drive (standard on Limited), or the part-time system with free wheeling front hubs (standard on Custom).

Full Time Quadra-Trac®

Quadra-Trac is a Jeep exclusive that provides sure-footed traction and a sense of security automatically while driving on highway in any weather or on any road surface. It's also a superb and predictable 4WD system for the most demanding of off road situations. A unique controlled slip differential in the transfer case sets Quadra-Trac apart from all other 4-wheel drive systems. When one wheel loses traction the controlled slip differential automatically delivers torque to the axle with the most traction helping to pull or push Wagoneer through trouble spots.

The process works instantly on any surface, resulting in excellent control, handling, stability and traction at all times, wherever you drive, and in all weather. That's security you'll be glad you have, in demanding driving situations.

Jeep Quadra-Trac automatic 4-wheel drive with automatic

transmission is standard on Wagoneer Limited and available on Wagoneer Custom. Viscous drive and a straight through high efficiency drive train design provide smooth, quiet operation. You select the driving range depending upon the surface condition: 4-Wheel High for normal operation; Low-Lock for extra push/pull power; Hi-Lock for very demanding situations. And, of course, you never have to leave the comfort of your Wagoneer...it's all automatic.

Quadra-Trac® System

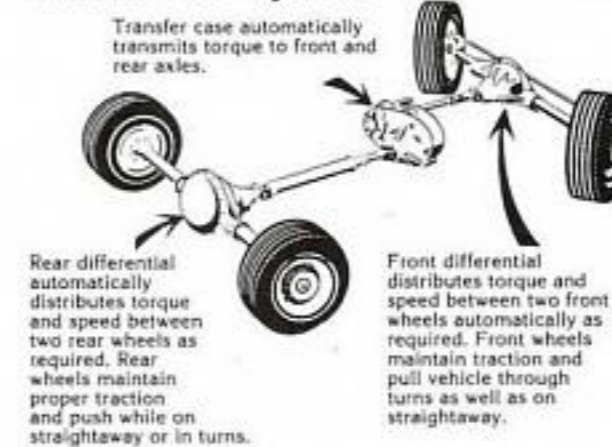

Part Time

Part time Jeep 4-wheel drive with a 4-speed, fully-synchronized manual transmission is standard on Wagoneer Custom. An optional automatic transmission teamed with the part-time system is available on all Wagoneer models.

In highway situations you simply slip the transfer case shift lever to the 2-wheel mode and unlock the front hubs. This disengages the front propeller shaft, front differential and front driving axles. Friction and noise are reduced accordingly.

For off road usage, just lock the front hubs, shift the transfer case to the 4-wheel mode and your Wagoneer becomes a go-anywhere-anytime vehicle for you, your family and all the luggage and provisions you need.

Vehicles illustrated in this brochure may vary slightly from actual production models.

This folder does not constitute an offer or commitment to sell. In order that product improvements may be made at any time, specifications and other data are subject to change without notice. Jeep vehicles incorporate thousands of different components produced by Jeep Corporation, affiliated companies and various independent suppliers. From time to time during the manufacturing process, it may be necessary to produce Jeep vehicles with different components or differently sourced components than initially scheduled. All components must meet the standards of Jeep Corporation and will provide the performance expected from Jeep vehicles. Jeep vehicles meet or exceed all applicable Federal Motor Vehicle Safety Standards at time of manufacture. Some of the Jeep vehicles shown and described in this brochure have optional equipment. JEEP®, QUADRA-TRAC®, WAGONEER®, JEEP STORE are trademarks of Jeep Corporation. In Canada, American Motors (Canada) Limited is a licensed user. ® Reg. TM. Merchandising/Jeep Sales Promotion 8/80 FORM#: 1-5424-835-01

Tires

Tiempo double steel belted radials have 10,000 biting edges to grip the road in any weather. P225/75R15—W/W

Arriva Steel Radial is a new American standard for radial tire performance. P225/75R15

F-32 Winter radials are made of Flexten for remarkable adhesion when driving on slippery winter pavement. HR78 x 15—W/W

Suburbanite fiberglass belted. An excellent Town & Country tire for smooth ride and positive traction. H78 x 15 BSW P225/75R15

Viva Fiberglass belted tire. A strong all-around radial for highway and off road. P225/75R15 BSW WSW.

Jeep Wagoneer Specifications

Wagoneer Dimensions

(inches unless otherwise noted)

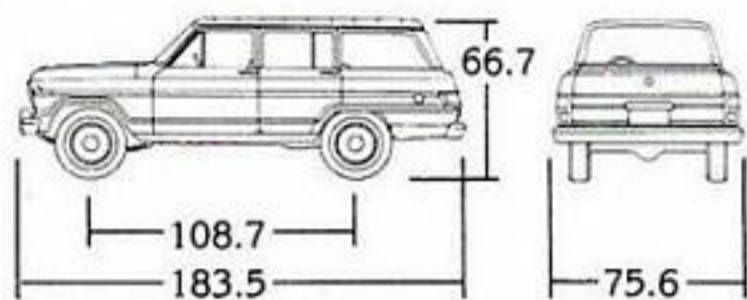

Exterior

Length	183.5
Wheelbase	108.7
Overall Width	75.6
Body Width	74.0
Height	66.7
Tread (front/rear)	59.4/57.8
Overhang (front/rear)	29.9/44.9
Min. ground clearance	7.7
Tailgate opening width	54.9
Turning diameter, Curb to curb (feet)	37.7

Interior

Head room (front/rear)	38.0/37.2
Leg room (front/rear)	41.6/37.0
Hip room (front/rear)	60.5/60.9
Shoulder room (front/rear)	58.3/58.3
Cargo volume (cu. ft.)	95.1*

* Rear seat removed.

Specifications

Axle, front	Full floating open-end; GAWR: 3200 lbs.
rear	GAWR: 3200 lbs.
Brakes	New low-drag power disc front (12" rotor); rear drum (11" x 2")
Fuel tank capacity	20.3 (approx.) gallons (w/skid plate)
4WD system	Part-time with manual free-wheeling front hubs (standard on Custom), Quadra-trac full-time automatic (standard on Limited)
Glass Area	5142.5 sq. in.
Gross vehicle weight	6200 lbs.
Springs, front	6 leaf 210 lbs./in. rate std.
rear	5 leaf 165 lbs./in. rate std.
Steering	Variable ratio, power
Transmission	Fully synchronized 4-speed manual floor shift (standard on Custom), automatic (standard on Limited, optional on Custom).
Tires	P225/75R15 BSW Viva fiberglass radials (Wagoneer Custom), P225/75R15 WSW, Arriva Steel radials (Limited). Temporary use polyspare.

Wheels

15 x 6 six-bolt, 5.5" circle standard; four 15 x 7 six-bolt, 5.5" circle forged aluminum wheels std. Wagoneer Limited (optional on Wagoneer)

Wagoneer Engine Availability

Engine	Carb.	Comp. Ratio	Bore & Stroke	Avail.
258 CID Six	2-bbl.	8.3:1	3.75" x 3.90"	std.
360 CID V-8*	2-bbl.	8.25:1	4.08" x 3.44"	opt.

* Not available in California.

Jeep engines utilize overhead valve configuration, lightweight, compact engine block castings and ambient air intake system for improved engine performance, greater durability and longer life.

EPA Mileage

22 Hwy. Est. MPG, **15** EPA Est. MPG

Use these figures for comparison. Your results may differ due to driving speed, weather conditions and trip length. Actual highway mileage will be less. California figures were not available at time of publication. Consult your Jeep Dealer.



Jeep CJ



Jeep Pickup

Drive one of our legends.



Jeep Cherokee



Jeep Wagoneer



Jeep Corporation is a subsidiary of American Motors Corporation

 **Jeep**[®]



Wagoneer

The ultimate four-wheel drive Wagon.



Few things so clearly state their timeless elegance as Jeep® Wagoneer does.

In a world of bland sameness, it's refreshing and comforting to know that Jeep Wagoneer remains unique in both form and function. Created, designed, engineered, and assembled by people mindful of the proud Jeep heritage, Wagoneer represents literally the very best of science and art. It is a

tastefully coordinated combination of advanced 4-wheel drive technology and appealing elegance in the form of supple leather, rich carpeting, and the look of fine grained wood. It has been regarded as rolling sculpture, and is, indeed, the ultimate 4-wheel drive wagon.

But don't think for a moment that a Wagoneer needs to be pampered. It doesn't. Because for all of its luxury features, it is still, at heart, a very rugged Jeep, incorporating over 40 years of Jeep tradition.

Toughness begins with a massive box section frame supporting a rigid four-door steel body. The mating of body and frame is checked by laser beam measuring devices to insure perfect non-stressed alignment.

Power is provided by a large capacity 6-cylinder 4.2 litre (258 CID) engine, with seven main bearings for long life. The standard transmission is a 4-speed manual with a 2-speed transfer case, for a total of 8 forward and 2 reverse

gears. An automatic transmission with a part-time four-wheel drive is also available. And new this year is a 5-speed full-synchromesh overdrive transmission for increased economy.

Also available is Quadra-Trac® acknowledged as the state of the art in 4-wheel drive systems. Quadra-Trac's unique transfer case contains a limited slip differential which "reads" the road surface and

automatically and smoothly sends power to the axle with the best grip on the terrain. It's exactly this type of technology that demonstrates that for all its plushness, Jeep Wagoneer still remains true to its roots as a vehicle built to get you there and bring you back.



No other 4-wheel drive wagon can provide Wagoneer's unique blend of creature comforts and 4-wheel drive capability.

Even in its basic form, Jeep Wagoneer has a high level of standard equipment. Full-gauged instrument panel, deep-pile carpets, padded sunvisors, heavily cushioned seats, fuel tank protection plate, stabilizer bar, and so much more.

Yet, there are two more deluxe Wagoneers. The "Brougham," with its unique approach to trim; and ultimately, the Wagoneer "Limited," which adds 30 additional items such as leather-trimmed seats and leather-wrapped steering wheel with a tilt adjustment, wood grained trim, AM/FM radio, air conditioning, and automatic transmission. A Jeep engineered trailer towing equipment package is also available. (The complete Limited list is on pages 6 and 7.)

Jeep Wagoneer, regardless of how it is equipped, is quite simply one of the world's unique vehicles. Able to carry a full-size passenger load and luggage in comfort on high speed roads, and then at the end of the road to continue on through fields, woods and streams with the same degree of comfort, safety and poise.

Jeep Wagoneer — it's as unique as you are. No other vehicle can compare.



Wagoneer shown with optional two-tone exterior. The table on page 7 lists other available color combinations.



These leather/corduroy bucket seats with a center armrest are standard on Wagoneer Limited.

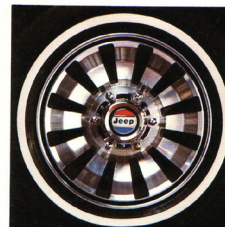

Forged aluminum wheels.



5-speed manual transmission with overdrive.



Wagoneer Brougham. For the complete list of equipment, see page 6.

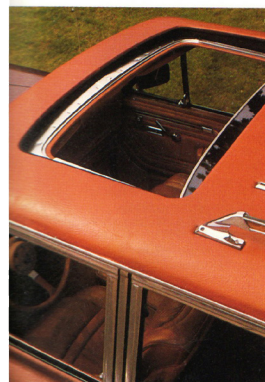

This power sunroof with vinyl top is available on the Wagoneer Limited.



Power windows/door locks.



Quartz digital clock.



Power seats.



Wagoneer Limited. The ultimate luxury in a 4-wheel drive vehicle.

Jeep® Wagoneer, while very complete in its base form, does offer an extensive list of optional equipment, colors and trim. Whether you plan to use your Wagoneer for work/utility or recreation, or some of both, you can equip it to precisely fit your

needs. (Not every item is available in every country — consult with your Jeep dealer for full details.)

Durability is built into every Jeep Wagoneer. One measure of this durability is the fact that 95% of all Jeep vehicles built in the last 10 years are still on the road in the

U.S. And, to help insure that your Wagoneer conforms to Jeep Corporation's exacting quality standards, every Jeep vehicle undergoes a 162-point inspection at the factory.

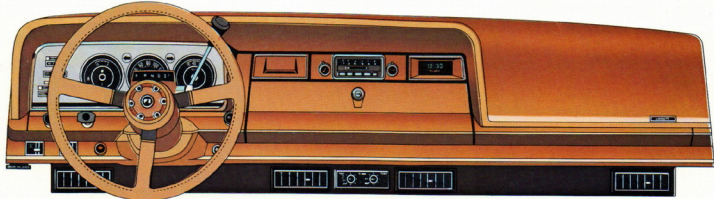

Electronic ignition system (requires no points or condenser)

5.9 litre (360 CID)* V-8 available

Automatic transmission with full-time 4-wheel drive transfer case — NP 219 (Quadra-Trac)*

Power steering with energy-absorbing steering column

Fuel tank — 76.8 litre capacity with standard skid plate

Heavy-duty ladder-type frame

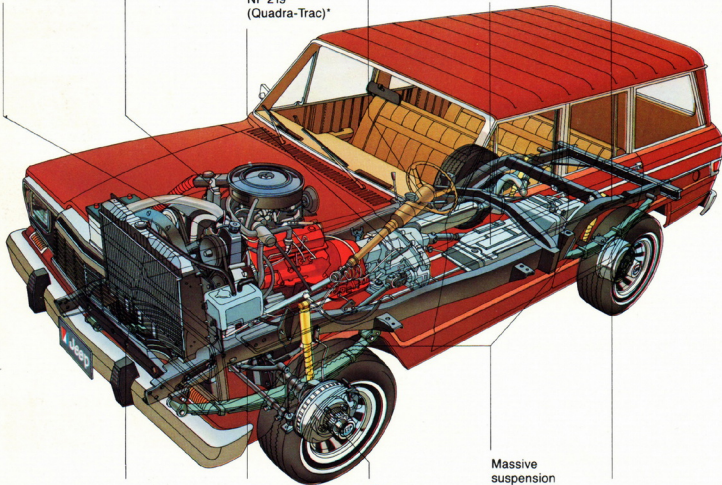

*Optional

Air conditioning*

Front stabilizer bar

Power front disc brakes

Massive suspension rated at 2810 kg GVW

Power rear drum brakes

Rustproofing

Frame and suspension parts are massive and designed for off-road use. Vulnerable areas, such as the fuel tank and lines, are protected by a steel skid plate. Care and attention have been given to improving corrosion resistance of critical sheet metal panels. For

example, one or two-sided galvanized steel has been used to form front side sills, lower-quarter panels, body hinge pillars, lower-body rocker panels, inner and outer wheelhouse panels, front and rear fenders, taillamp mounting plates, inner and outer tailgate and door panels

and cowl top ventilator grille. Hot waxes are applied in hard-to-paint boxed sections on each vehicle. After painting, the body is baked to thoroughly bond the paint to the body surfaces. Even frame and suspension parts are heavily coated to minimize corrosion.

E

quipment that's tough enough for a Wagoneer is designed and supplied by Jeep.

Special Models

Wagoneer Brougham

Includes all equipment from base model plus the following:

Exterior

- Bright door and quarter-window frames
- Bright lower tailgate moldings
- Body side scuff moldings with wood-grain insert
- Argent styled steel wheels with trim rings

Interior

- Bench seat in Coventry Check fabric
- Custom door trim panels
- Wood-grain overlay on instrument panel cluster
- Steering wheel with wood-grain horn cover

Functional

- Convenience Group
- Extra-quiet insulation
- Light Group
- Power tailgate window
- Protective floor mats

Wagoneer Limited

Includes all equipment from base model plus the following:

Exterior

- Wide wood-grain moldings side and rear or special two-tone paint
- Roof rack with wood-grain inserts
- Bright roof drip rail overlay
- Bumper guards and nerfing strips (front and rear)
- Forged aluminum wheels (4)
- "Limited" nameplates
- P225/75R 15 (B) whitewall steel radial Arriva tires
- Bright door, quarter-window frame and tailgate moldings

Interior

- Bucket seats with leather/corduroy trim, center armrest and unique door panels (nutmeg or beige)
- Leather-wrapped steering wheel
- Extra-thick carpeting in seating area (carpeted cargo area with insulation)
- Wood-grain overlay on lower instrument panel

- "Limited" nameplate on instrument panel
- Protective floor mats
- Extra-quiet insulation
- Cargo area cover (retractable)
- Soft headliner

Special Equipment

- Air conditioning
- Power tailgate window
- Cruise control
- Tilt steering wheel
- AM/FM stereo radio
- Premium audio system
- Power six-way driver and passenger seats
- Convenience Group
- Power side windows/door locks
- Visibility Group
- Tight Group
- Electric remote control mirrors, left and right

Power Train

- **Handling Components**
- Automatic transmission with Quadra-Trac full-time 4-wheel drive
- 258 CID 2-barrel engine

Options

Handling and Performance

- 5.9 litre (360 CID) 2-barrel V-8
- 5-speed full synchromesh manual overdrive transmission (6-cyl.)
- Automatic transmission with part-time 4-wheel drive
- Automatic transmission with Quadra-Trac full-time 4-wheel drive*
- Rear Trac-Lok® differential
- Free wheeling hubs (NA with automatic Quadra-Trac)

Exterior

- Two-tone paint
- Sun Roof® (removable)
- Power sun roof with vinyl roof (Limited only)
- Wood-grain trim panels with bright surround moldings
- Forged aluminum styled wheels*
- Argent styled wheels with trim rings**
- Roof rack with adjustable bars*
- Dual low-profile mirrors (NA Wagoneer Limited)
- Bumper guards and nerfing strips, front and rear*
- Scuff molding — body side with wood-grain insert (NA with woodgrain side panels or low-profile mirrors)
- Halogen fog lamps

Interior and Convenience

- Fabric or special vinyl front and rear bench seats (NA Wagoneer Limited)
- Fabric front bucket and rear bench seats (NA Wagoneer Limited)
- Seat belts
- Power six-way driver's seat
- Power six-way driver's and passenger's seat*
- Power tailgate window**
- Leather-wrapped steering wheel*
- Protective floor mats, front and rear**
- Cargo area carpet and insulation: includes carpeted floor, carpeted wheelhouse, carpeted tailgate, extra

insulation, skid moldings*

- Convenience Group: includes electric digital clock, under-hood light, "headlights-on" warning buzzer**
- Electric remote-control mirrors, left and right*
- Visibility Group: includes remote-control mirrors (left and right), intermittent wipers, Halogen headlamps*
- Extra-quiet insulation: includes padded headliner, under-dash insulation, noise deadener on passenger floor area and wheelhouses, carpeted floor and insulation**
- Air conditioning*
- Rear window defroster (requires power tailgate window)
- Tilt steering wheel*
- Light Group: includes cargo area light, glove box light, dome light, courtesy light, ashtray light, lighted visor vanity mirror**
- Inside spare tire mount and cover (NA Wagoneer Limited)
- Cargo area cover (retractable)*
- Cruise control*
- AM radio
- AM/FM stereo radio*
- AM/FM/CB stereo radio
- Electronically tuned AM/FM cassette stereo radio
- Premium audio system*
- Power door locks
- Power side windows/door locks*
- Electric mirrors

Heavy-Duty Equipment

- Heavy-duty cooling
- Soft-ride suspension (specifically tuned for on-road usage)
- Heavy-duty suspension
- Cold Climate Group
- Auxiliary automatic transmission oil cooler
- Heavy-duty battery
- Heavy-duty front and rear shock absorbers
- Extra heavy-duty front springs
- Air shock absorbers

Other options are available for your Jeep Wagoneer. See your authorized Jeep dealer for details.

Tire Options

- **Suburbanite XG®** H78-15 (B) blackwall tubeless (NA Wagoneer Limited)
- **Custom XG®** Hi-Miler 7.00-16 LT (C) with tubes (NA Wagoneer Limited)
- **Suburbanite XG®** H78-15 (B) blackwall with tubes (NA Wagoneer Limited)
- Highway P225/75 R15 (B) Arriva® whitewall radial tubeless*

Trailer Towing

Trailer towing packages are available for your Jeep Wagoneer. Your dealer has a list of required and recommended equipment. He can help ensure that your Wagoneer is in compliance with all local trailer regulations and requirements.

*Included on Wagoneer Limited
**Included on Wagoneer Limited and Brougham

Exterior and Interior Colors and Seat Trims

Standard Exterior Colors

	Two-tone Option**	Wagoneer Limited Exterior Interior/ Leather Color Combinations	
Available on all Wagoneers except Limited model noted at right			
Olympic White	NA	Nutmeg	Beige
Classic Black	NA	■	■
Mist Silver Metallic*	Slate Blue Metallic	NA	NA
Slate Blue Metallic*	Deep Night Blue	NA	NA
Deep Night Blue*	NA	■	NA
Sherwood Green Metallic	NA	■	■
Jamaican Beige*	Copper	■	■
Topaz Gold Metallic*	NA	■	■
Copper Brown Metallic	Chestnut Brown Metallic	■	■
Chestnut Brown Metallic	NA	■	■
Vintage Red Metallic	Deep Maroon Metallic	NA	NA
Deep Maroon Metallic	NA	NA	■

*New color for 1982

**Lower-body color



Interior Seat Trims

Cara Vinyl — std. (NA Wagoneer Limited)



Deluxe Grain Vinyl — std. Brougham (NA Wagoneer Limited)



Coventry Checked Fabric — std. Brougham (NA Wagoneer Limited)



Leather/Corduroy — std. Wagoneer Limited

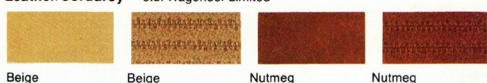

S pecifications.

Jeep® Wagoneer specifications are the result of over 40 years of development by Jeep, the world's best known 4-wheel drive manufacturer. Every Wagoneer is engineered, tested and built from the ground up to meet specific requirements of a truly fine 4-wheel

drive vehicle. Complete specifications for all Wagoneer models follow.

Not every Wagoneer model is available in every country. Talk with your Jeep dealer to determine specific model availability.

Wagoneer Standard Features

Exterior

- Bright exterior trim moldings, windshield and roof rail
- Bumpers — front and rear, bright aluminum
- Lights — head, parking, tail and stop, backup, directional signals (with lane changer feature), side safety markers and 4-way hazard flashers
- Mirror — outside driver side
- Tinted glass, all windows
- Windshield — high-impact-resistant glass

Interior

- Ashtrays — front and rear
- Armrests — front and rear
- Cigar lighter
- Door trim panels, Cara vinyl
- Floor covering — carpeted (front and rear seat floor area and wheelhouse covers), vinyl cargo area mat
- Gauges — oil, temperature, ammeter, fuel
- Glove box lock
- Mirror — 30.5 cm inside day/night rearview
- Padded instrument panel
- Padded sun visors (2)
- Seats — bench (front and rear) in Cara vinyl

Functional

- Air cleaner — cellulose-fiber
- Alternator — 12-volt, 63-amp
- Battery — 12-volt (55-380 cold crank)
- Brakes — front power disc and rear drum
- Brakes, parking — foot-lever actuated with warning light, operates on rear wheels
- Coolant — permanent type (50/50 mixture)
- Electronic ignition system
- Exhaust system — single
- Fuel filters — tank and in-line at carburetor
- Fuel tank skid plate
- Heater and defroster
- Horns — dual
- Oil filter
- Radio interference suppression
- Stabilizer bar — front
- Steering — power
- Steering column — energy-absorbing with anti-theft ignition, steering and transmission lock (automatic)
- Tools — bumper-type jack, 660 kg capacity, combined wheel wrench and jack handle
- Washers — electric and 2-speed electric wipers
- Wheel trim — wheel covers 38.1 cm (4)

Wagoneer Specifications

Axle, front	Full-floating open-end; gross axle weight rating: 1452 kg.
rear	Semi-floating; GAWR, 1451 kg.
Brakes	Power disc front (30.5 cm rotor); rear drum (27.9 cm x 5.08 cm)
Clutch	27.9 cm diameter
Engine	Standard — 4.2 litre (258 CID) OHV Six; 8.6:1 compression ratio Optional — 5.9 litre (360 CID) OHV V-8; 8.3:1 compression ratio
Fuel tank	76.8 litres; skid plate standard
Glass area	3.32 sq. m total
Gross vehicle weight	2810 kg.
Springs, front	5 leaf .27 mm/daN deflection rate standard
rear	5 leaf .35 mm/daN deflection rate standard
Steering	Recirculating ball standard, 24:1 ratio; variable ratio power standard
Tires	Five H78 x 15B blackwall Suburbanite X-Grip® tubeless
Transfer case	Part-time 2-speed NP 208 standard with 2.62:1 low range gear reduction; Quadra-Trac® full-time automatic 4-wheel drive is optional
Transmission	Fully-synchronized 4-speed floor shift (manual) standard; 5-speed manual overdrive optional (6-cylinder only) and column-mounted automatic (optional)
Wheels	Five 38.1 cm x 15.2 cm 6-bolt, 14 cm circle standard; four 38.1 cm x 17.8 cm 6-bolt, 14 cm circle forged aluminum wheels optional

Wagoneer Dimensions

(Centimeters unless otherwise noted)

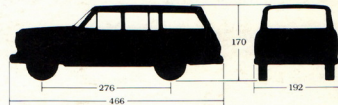

Exterior (cm)

Length	473
Wheelbase	276
Max. body width	188
Max. overall width	190
Height	169
Tread (front/rear)	151/147
Overhang (front/rear)	80/118
Min. ground clearance	20
Tailgate opening width	139
Curb to curb turning diameter (meters)	11.49

Interior

Head room (front/rear)	94/95
Leg room (front/rear)	103/93
Hip room (front/rear)	154/155
Shoulder room (front/rear)	148/148
Cargo volume (m ³)	2.69
Payload capacity (kg)	1041

There's only one Jeep.® We build it.

 **Jeep Corporation**

This folder does not constitute an offer or commitment to sell. In order that product improvements may be made at any time, specifications and other data are subject to change without notice. Some of the Jeep® Wagoneers shown and described in this brochure have optional equipment, available at extra cost. See your authorized Jeep dealer for prices and model availability for this optional equipment. In order to conform to local regulations, your Jeep vehicle may differ slightly from those shown in this brochure.

Jeep Wagoneer and Quadra-Trac are trademarks of Jeep Corporation. JEEP CORPORATION, 27777 Franklin Rd., Southfield, Michigan 48034 U.S.A. Telex No. 023-1255, Cable Code AMCENTRINT. 82-WAG-1E Litho in U.S.A.