



## *Electrical Library*

---

*Elektrotechnische  
Bibliotheek*

*Librairie Electrique*

*Elektrohandbuch*

*Libreria Impianto  
Elettrico*

*Biblioteca Electrónica*

*Livraria Eléctrica*



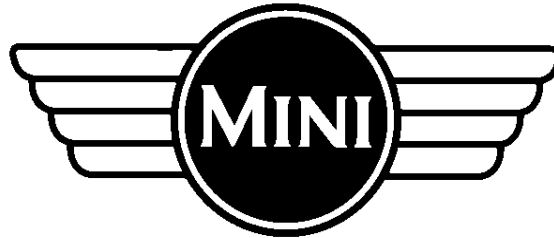

# **ELECTRICAL REFERENCE LIBRARY**

---

This Manual should be used in conjunction with the following publications:

RCL 0193ENG	Workshop Manual
RCL 0194ENG	Electrical Circuit Diagrams

Publication Part No. RCL 0213ENG  
Published by Rover Technical Communication

©1997 Rover Group Limited

---

<b>INTRODUCTION</b> .....	<b>1.1</b>
References .....	1.1
Battery voltage .....	1.2
Open circuit voltage test.....	1.2
<b>ELECTRICAL PRECAUTIONS</b> .....	<b>1.3</b>
General.....	1.3
Battery disconnecting.....	1.4
Battery charging .....	1.4
Disciplines .....	1.5
Grease for electrical connectors.....	1.5
<b>ABBREVIATIONS</b> .....	<b>1.6</b>
<b>HOW TO USE THIS DOCUMENT</b> .....	<b>1.8</b>
<b>WIRE COLOUR CODES</b> .....	<b>1.12</b>
<b>FUSE DETAILS</b> .....	<b>2.1</b>
ENGINE COMPARTMENT FUSE BOX.....	2.1
PASSENGER COMPARTMENT FUSE BOX.....	2.2
MODEL/FEATURE APPLICABILITY TABLE.....	2.4
<b>EARTH POINTS AND HEADER JOINTS</b> .....	<b>3.1</b>
Earth Points.....	3.1
Earth Headers .....	3.2

# CONTENTS

---

<b>DESCRIPTION AND OPERATION .....</b>	<b>4.1</b>
ANTI-THEFT ALARM OPERATION.....	4.1
Handset .....	4.1
Perimetric alarm .....	4.2
Engine immobilisation .....	4.2
Passive engine immobilisation .....	4.3
Handset battery replacement .....	4.3
Vehicle battery .....	4.3
HORNS OPERATION .....	4.4
SUNROOF OPERATION .....	4.5
CHARGING AND STARTING SYSTEM OPERATION.....	4.6
Charging system.....	4.6
Starting system.....	4.7
MPI .....	4.7
SPI.....	4.7
MODULAR ENGINE MANAGEMENT SYSTEM (MEMS).....	4.8
PROGRAMMED IGNITION SYSTEM.....	4.9
MEMS ECM.....	4.9
Crankshaft position (CKP) sensor .....	4.10
Camshaft position (CMP) sensor.....	4.10
Manifold absolute pressure (MAP) sensor.....	4.10
Engine coolant temperature (ECT) sensor.....	4.11
Manifold heater (Japan only) .....	4.11
Throttle position sensor .....	4.11
Idle speed control .....	4.11
FUEL INJECTION SYSTEM .....	4.11
Idle air control valve (stepper motor) .....	4.13
Intake air temperature sensor.....	4.13
Catalytic Converter System .....	4.13
Heated oxygen sensor.....	4.13
Purge valve.....	4.14
Automatic gearbox.....	4.14
Inhibitor switch .....	4.14
FUEL PUMP OPERATION.....	4.15

BRAKE FLUID LEVEL WARNING OPERATION .....	4.16
Brake test switch .....	4.16
SRS (AIRBAG) OPERATION .....	4.17
Driver's airbag .....	4.18
Pre-tensioners .....	4.18
SRS warning lamp .....	4.18
SEAT BELT WARNING OPERATION (JAPAN ONLY).....	4.19
AIR CONDITIONING OPERATION (JAPAN) .....	4.21
MEMS ECM.....	4.21
Air conditioning switch and condenser fan .....	4.21
Aircon blower motor, switch and resistor pack .....	4.22
Dual pressure switch .....	4.22
HEATER BLOWER OPERATION .....	4.23
COOLING FAN OPERATION .....	4.24
MPI .....	4.24
SPI (Japan only).....	4.24
HEATED REAR WINDOW OPERATION.....	4.25
WINDSCREEN WIPERS AND WASHERS OPERATION .....	4.26
Intermittent wipe .....	4.26
Wiper normal speed .....	4.26
Wiper fast speed .....	4.26
Single wipe .....	4.27
Wash/wipe.....	4.27
Wiper motor park .....	4.27

# CONTENTS

---

EXTERIOR LIGHTS .....	4.28
Brake lamps operation .....	4.28
Reverse lamps operation .....	4.28
Head, side, tail and number plate lamps operation .....	4.29
Headlamps .....	4.29
Dipped beam .....	4.29
Main beam .....	4.29
Headlamp flash.....	4.29
Side and tail lamps .....	4.30
Number plate lamps .....	4.30
Front fog and driving lamps operation .....	4.31
Front fog lamps.....	4.31
Driving lamps.....	4.31
Front fog and driving lamps operation (Japan).....	4.32
Front fog lamps.....	4.32
Driving lamps.....	4.32
Rear fog lamps operation .....	4.33
Headlamp levelling operation .....	4.34
Headlamp levelling switch .....	4.34
INDICATORS AND HAZARD SYSTEM OPERATION .....	4.35
Indicators .....	4.35
Right .....	4.35
Left.....	4.35
Hazard warning .....	4.36

INTERIOR LAMP CIRCUIT OPERATION .....	4.37
INTERIOR ILLUMINATION .....	4.38
INSTRUMENT PACK OPERATION .....	4.39
Coolant temperature gauge.....	4.39
Fuel gauge .....	4.39
Clock .....	4.39
Ignition/no charge warning lamp .....	4.40
Oil pressure warning lamp.....	4.40
Indicator warning lamps .....	4.40
Main beam warning lamp .....	4.40
Airbag warning lamp.....	4.40
Tachometer .....	4.41
Voltage gauge .....	4.41
Oil temperature gauge.....	4.41
IN-CAR ENTERTAINMENT OPERATION.....	4.42
<b>CONNECTOR .....</b>	<b>Indexed by connector number</b>

This document is intended to assist in diagnosing electrical faults, and should be used in conjunction with the Electrical Circuit Diagrams. The document is divided into the following five sections:

1. **INTRODUCTION** - includes Electrical Precautions, a list of Abbreviations and general information on how to use the document.
2. **FUSE DETAILS** - provides details of location, rating in amps, wire colour and circuit(s) protected.
3. **EARTH POINTS AND HEADER JOINTS** - provides details of earth points, earth and power header joints, including a plan view of the vehicle to aid location.
4. **DESCRIPTION AND OPERATION** - provides an explanation of how each of the systems operate.
5. **CONNECTOR** - details of connectors including a location photograph, face view and pin-out table.



**NOTE: Before starting electrical checks on the vehicle, ensure that the relevant mechanical functions operate satisfactorily.**

## References

References to the LH or RH side given in this document are made when viewing the vehicle from the rear.

Operations covered in this document do not include reference to testing the vehicle after repair. It is essential that work is inspected and tested after completion and, if necessary, a road test of the vehicle undertaken, particularly where safety related items are concerned.





**Caution:** Before undertaking any electrical work on a vehicle **ALWAYS** read the **ELECTRICAL PRECAUTIONS** detailed on the next page.

### **Battery voltage**

Before commencing diagnosis of electrical problems verify the condition of the battery is acceptable by using the open circuit voltage test.

#### ***Open circuit voltage test***

Switch off all electrical loads on the vehicle.

Adjust digital multimeter to read d.c. volts on the appropriate scale.

Connect test probes across battery terminals ensuring that polarity is correct and record the voltage displayed.

**A reading of 12.3V or more is acceptable; any battery which reads less than this will need charging.**



**NOTE:** If the vehicle has been used within a period of 8 hours prior to the test, surface charge must be removed from the battery by switching the headlamps on for approximately 30 seconds.

**Wait a further 60 seconds before checking the open circuit voltage.**

Battery voltage is used as a known reference for ascertaining whether or not circuits are receiving sufficiently high voltage for components to function correctly. This reference is only a guide since most electronic circuits are designed to function over a wide range of voltages. In addition, consideration must be given to readings affected by voltage drop across certain components and fluctuations due to cable lengths.

## ELECTRICAL PRECAUTIONS

### General

The following guidelines are intended to ensure the safety of the operator whilst preventing damage to the electrical and electronic components fitted to the vehicle. Where necessary, specific precautions are detailed in the relevant sections of this document, reference to which should be made prior to commencing repair operations.

Equipment - Prior to commencing any test procedure on the vehicle ensure that the relevant test equipment is working correctly and any harness or connectors are in good condition. This particularly applies to mains lead and connections.



**WARNING: Before commencing work on an ignition system all high tension terminals, adapters and diagnostic equipment for testing should be inspected to ensure that they are adequately insulated and shielded to prevent accidental personal contact and to minimise the risk of shock. Wearers of surgically implanted pacemaker devices should not work in close proximity to ignition circuits or diagnostic equipment.**

Polarity - Never reverse connect the vehicle battery and always observe the correct polarity when connecting test equipment.

High Voltage Circuits - Whenever disconnecting live ht circuits always use insulated pliers and never allow the open end of the ht lead to come into contact with other components particularly ECUs. Since high voltage spikes can occur on the terminals of the coil while the engine is running, exercise caution when measuring the voltage at these points.

## INTRODUCTION

---

Connectors and Harness - The engine compartment of a vehicle is a particularly hostile environment for electrical components and connectors. Always ensure these items are dry and oil free before disconnecting and connecting test equipment. Never force connectors apart either by using tools or by pulling on the wiring harness. Always ensure locking tabs are disengaged before removal and note orientation to enable correct reconnection. Ensure that any protective covers and substances are replaced if disturbed.

Before removing a faulty component, refer to the Workshop Manual for removal procedures. Ensure the starter switch is turned to the 'OFF' position, the battery is disconnected (see Battery disconnecting) and any disconnected harnesses are supported to avoid any undue strain at terminals. When replacing the component keep oily hands away from electrical connection areas and push connectors home until any locking tabs fully engage.

### Battery disconnecting

Before disconnecting the battery, switch off all electrical equipment. If the radio is to be serviced, ensure the security code has been deactivated.



**Caution: To prevent damage to electrical components ALWAYS disconnect the battery when working on the vehicle electrical system. The earth lead must be disconnected first and reconnected last. Always ensure that battery leads are routed correctly and are not close to any potential chafing points.**

### Battery charging

Recharge the battery out of the vehicle and keep the top well ventilated. While being charged or discharged, and for approximately fifteen minutes afterwards, batteries emit hydrogen gas. This gas is inflammable.

Always ensure any battery charging area is well ventilated and that every precaution is taken to avoid naked flames and sparks.

## Disciplines

Switch off ignition prior to making any connection or disconnection in the system as electrical surge caused by disconnecting 'live' connections can damage electronic components.

Ensure hands and work surfaces are clean and free of grease, swarf, etc. as grease collects dirt which can cause tracking or high-resistance contacts.

When handling printed circuit boards, treat them as you would a disc - hold by the edges only; note that some electronic components are susceptible to body static.

Connectors should never be subjected to forced removal or refit, especially inter-board connectors, damaged contacts will cause short-circuit and open-circuit conditions.

Prior to commencing test, and periodically during test, touch a good earth, i.e. cigar lighter socket, to discharge body static as some electronic components are vulnerable to static electricity.

## Grease for electrical connectors

All under bonnet and under body connectors are protected against corrosion by the application of a special grease on production. Should connectors be disturbed in service or repaired or replaced, a grease of this type, available under Part No. BAU 5811, should again be applied.



**NOTE: The use of other greases must be avoided as they can migrate into relays, switches etc. contaminating the contacts and leading to intermittent operation or failure.**

# INTRODUCTION

---

## ABBREVIATIONS

A	- Amps
ac	- Alternating current
A/C or Aircon	- Air conditioning
ABS	- Anti-lock braking system
Cav	- Cavity
Cct	- Model or feature applicability
CDL	- Central door locking
Col	- Colour
dc	- Direct current
DCU	- Diagnostic and control unit
ECU	- Electronic control unit
ECM	- Engine control module
EDC	- Electronic diesel control
F	- Fuse
FICV	- Fast idle control valve
FL	- Fusible link
HRW	- Heated rear window
IACV	- Idle air control valve
ICE	- In-car entertainment
IMA	- Idle mixture adjust

LCD	- Liquid crystal display
LED	- Light emitting diode
LH	- Left hand
LHD	- Left hand drive
MAP	- Manifold absolute pressure
MEMS	- Modular engine management system
MFU	- Multi-function unit
MPI	- Multi-point injection
NON CDL	- Without Central door locking
PA	- Atmospheric pressure
PGM-Fi	- Programmed fuel injection
RH	- Right hand
RHD	- Right hand drive
SPI	- Single-point fuel injection
SRS	- Supplementary restraint system
TA	- Air temperature
TDC	- Top dead centre
TH	- Throttle angle
TW	- Water temperature

## HOW TO USE THIS DOCUMENT

### Fuse details

Contains information on fuse functions and values and should be used together with the power distribution circuit diagrams to establish which systems share a common power supply and to ensure that correct value fuses are fitted.

### Earth points and headers joints

Shows a plan view of the vehicle including location of all earth points. Supporting photographs and connector detail information appear in the Connector section.

### Description and Operation

Presented in the same order as the circuit diagrams are displayed in the Electrical Circuit Diagram folder, each of the descriptions contains a brief overview of the main system functions and includes operating parameters for sensors and switches and reference to the appropriate wire colours. Always read this section before starting work on a system so that a good understanding of system functionality is obtained.

### Connector

This section is effectively an index of every electrical connector on the vehicle, including header joints and eyelets. A page is dedicated to each connector, with the information presented in a standard format. The connector number is displayed on each page header to ease reference. Connector information comprises:

- **Connector Number** - The assigned number, prefixed "C".
- **Connector Name** - Usually derived from the component to which the connection is made.
- **Male/Female** - If applicable, identifies the gender of the connector pins (NOT the housing) as Male or Female. Generally, connectors mating directly to a component have Female pins.

- **Colour** - If applicable, the colour of the connector housing is shown. NATURAL is used to describe connectors with a clear/translucent plastic finish.
- **Location Statement** - Used in conjunction with the photograph to determine the location of the connector.
- **Photograph** - Shows the location of the subject connector. In most cases, the photograph will indicate the amount of trim removal necessary to reveal the connector. For convenience some photographs identify more than one connector.
- **Face View** - An outline of the connector housing, viewed from the front, showing pin numbers (if applicable).

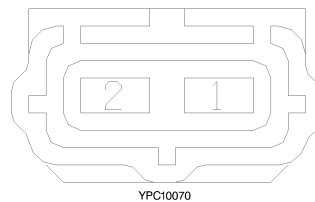

- **Pin-out Table** - A three column table, detailing the colour and position of each wire in the connector:
- 

Cav	Col	Cct
1	GR	ALL
2	B	ALL

**Cav:** The connector pin (cavity) number.

**Col:** The colour of wire populating the connector pin.

**Cct:** Identifies the model or feature which uses the wire. ALL means applicable to all vehicles in the range.



## INTRODUCTION

---

Where necessary a table listing the circuit reference numbers against a description of the model or features which may or may not be fitted, can be found at the beginning of the Connector section. A sample of a typical table is shown below:

<b>Cct</b>	<b>Model or feature</b>
1	Electric windows
2	Electric windows and headlamp levelling
3	Headlamp levelling
4	Without headlamp levelling
5	Airbag
6	Without airbag
7	Alarm
8	Rear speakers

## **Fault diagnosis**

When diagnosing an electrical fault follow the steps below:

1. Read the circuit description appropriate to the reported fault to ensure a good understanding of circuit operation.
2. Study the power distribution, fuse details and earth distribution diagrams and identify other circuits which share fuses and/or earth points. Check whether these circuits operate correctly.
3. Using the photographs contained in the Connector section, locate a point on the circuit (approximately half way between supply and earth) which is easily accessible.
4. Check that the pin out details of the connector are correct and that the correct signals exist at the correct terminals.
5. Using the marker pen supplied (or other suitable non-permanent marker pen), mark the parts of the circuit you have verified.
6. Continue to the next point on the circuit which is easiest to access and repeat the above.
7. Continue this approach until a fault is found, rectify the fault and then verify that the circuit operates correctly.

# INTRODUCTION

---

## WIRE COLOUR CODES

The following list contains the wire colour codes used on the vehicle harnesses and is intended to give an indication of the function or feature for which a particular colour of wire is normally used. These guidelines do not always apply to the wiring between components and the main harness.

Code	Colour	Function
B	Black	Earth wire from a component to an earth tag. Black with a tracer is also usually an earth wire but the earth is switched by a control unit.
G	Green	Ignition fused supply from passenger compartment fusebox: clock, instrument, indicators, electric mirrors
K	Pink	Fused supply: central door locking
LG	Light Green	Ignition auxiliary fused supply from passenger compartment fusebox: reverse lamps, brake lamps
N	Brown	Battery supply - to ignition switch from fusible link 3 and 5
O	Orange	Fused supply: central locking
P	Purple	Fused permanent supply - to interior lamps, radio cassette, clock, anti-theft alarm, electric aerial
R	Red	Fused supply: sidelamps
S	Slate (grey)	Fused supply: electric windows
U	Blue	Fused supply: headlamps, cooling fans
W	White	Ignition switched supply to passenger compartment fusebox
Y	Yellow	Ignition switched supply to passenger compartment fusebox

## INTRODUCTION

The fuses are mounted in two fuse boxes; one is in the engine compartment and the other in the passenger compartment, high in the driver's footwell. In addition, the front fog lamp relay receives battery voltage via a 15A fuse (stand-alone fuse holder) mounted at the rear RH side of the engine compartment.

The engine compartment fuse box contains high current pull-out fuses which feed multiple circuits.

The fuses in the passenger compartment fuse box are all of the smaller pull-out type.

### Engine Compartment Fuse Box

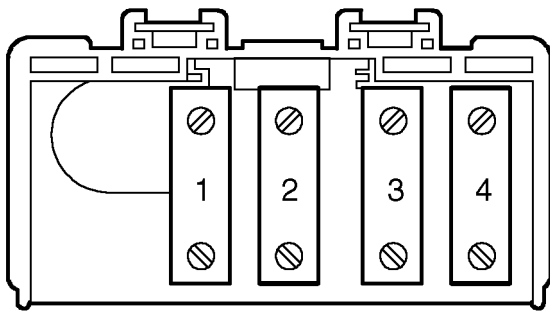

86M4220

Link	Rating	Wire Colour	Function
1	30 amp	N	Passenger compartment fuse box - fuses A9, B1, B6, B9 and C4
2	30 amp	N	Ignition switch, auxiliary relay
3	30 amp	N	Lighting switch
4	30 amp	N	MEMS relay module / manifold heater relay (Japan)

# FUSE DETAILS

## Passenger Compartment Fuse Box

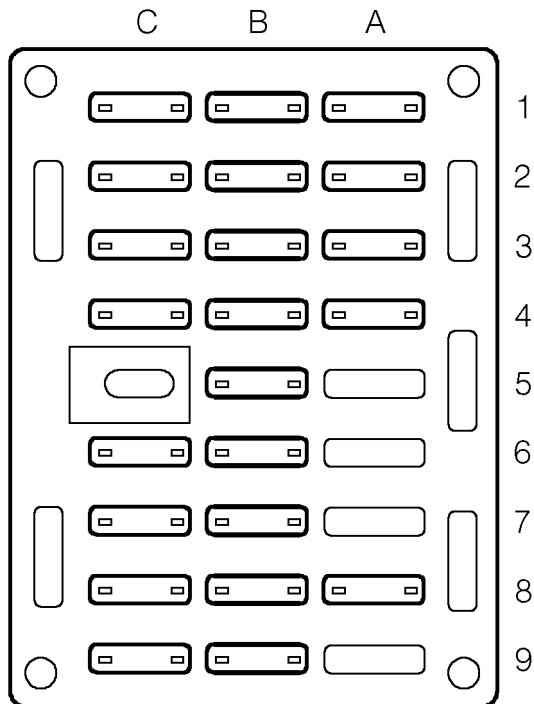

86M4224

Fuse	Rating	Wire Colour	Function
A1	10 amp	UW	RH headlamp main beam, driving lamp relay
A2	10 amp	UR	RH headlamp dipped beam
A3	10 amp	RW	RH side and tail lamps
A4	10 amp	W	Alarm ECU, instrument pack, voltage gauge, oil temperature gauge
A5	-	-	Not used
A6	10 amp	G	A/C relay, switch pack, thermostat, seat belt warning lamp, catalyst overheat ECU (Japan only)
A7	15 amp	LGW	A/C blower motor (Japan only)
A8	15 amp	LGO	Blower motor
A9	20 amp	U	A/C relay (Japan only)

B1	15 amp	P	Driving lamp relay
B2	10 amp	UO	Rear fog guard
B3	10 amp	R	Headlamp levelling
B4	10 amp	LGW	Radio cassette, cooling fan relay (Japan), automatic gearbox selector indicator lamp
B5	10 amp	G	Airbag control unit
B6	20 amp	P	Alarm system and horn
B7	15 amp	R	Sunroof
B8	15 amp	LGO	Wipers and washer
B9	15 amp	P	Cooling fan
C1	10 amp	UW	LH headlamp main beam
C2	10 amp	UR	LH headlamp dipped beam
C3	10 amp	RB	LH side and tail lamps
C4	10 amp	PO	Radio cassette, clock, brake system warning light, direction indicator/ hazard warning unit, anti-theft alarm indicator light, interior lamp unit
C5	-	-	Not used
C6	15 amp	G	Direction indicator relay, brake and reversing lamps
C7	10 amp	NS	Inertia fuel shutoff switch
C8	10 amp	WR- WK	MEMS relay module (starter relay)
C9	15 amp	G	Heated rear window

A face view of the of the passenger compartment fuse box is not shown in the Connector section of this document since it consists of single Lucars connected in accordance with the following table:

## FUSE DETAILS

---

Cav	Col	CCT
A1-1	UW	ALL
A1-2	UW	ALL
A2-1	UR	ALL
A2-2	UR	ALL
A3-1	R	ALL
A3-2	RW	ALL
A4-1	W	ALL
A4-2	W	ALL
A6-1	W	1
A6-2	G	1
A7-1	LGW	1
A7-2	LGW	1
A8-1	LGW	ALL
A8-2	LGO	ALL
A9-1	N	1
A9-2	U	1

Cav	Col	CCT
B1-1	N	ALL
B1-2	P	ALL
B2-1	U	ALL
B2-2	UO	ALL
B3-1	R	ALL
B3-2	R	ALL
B4-1	LGW	ALL
B4-2	LGW	ALL
B5-1	W	ALL
B5-2	G	ALL
B6-1	N	ALL
B6-2	P	ALL
B7-1	Y	ALL
B7-2	R	ALL
B8-1	LGW	ALL
B8-2	LGO	ALL
B9-1	N	ALL
B9-2	P	ALL

Cav	Col	CCT
C1-1	UW	ALL
C1-2	UW	ALL
C2-1	UR	ALL
C2-2	UR	ALL
C3-1	R	ALL
C3-2	RB	ALL
C4-1	N	ALL
C4-2	PO	ALL
C6-1	W	ALL
C6-2	G	ALL
C7-1	NS	ALL
C7-2	NS	ALL
C8-1	WR	ALL
C8-2	WR	ALL
C9-1	Y	ALL
C9-2	G	ALL

### MODEL/FEATURE APPLICABILITY TABLE

This table lists the circuit reference number(s) against a description of the model or feature to which it applies:

Cct	Model or feature applicability
1	Japan only
ALL	Applies to all models and derivatives

## Earth Points

The following illustration indicates the general position of each Earth Point on the vehicle.

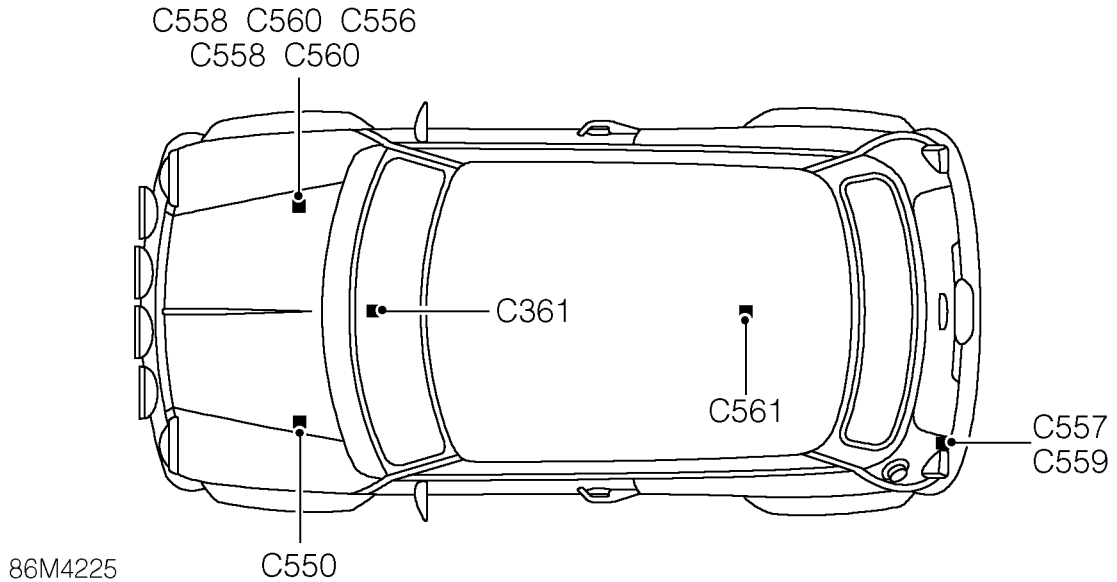

Connector No	Title	Location
C361	Earth eyelet - radio	Behind centre of fascia
C556	Earth eyelet 1	RH side of engine compartment
C557	Earth eyelet 2	Luggage compartment - LH side
C558	Earth eyelet 3	RH side of engine compartment
C559	Earth eyelet 4	Luggage compartment - LH side
C560	Earth eyelet 5	RH side of engine compartment
C561	Earth eyelet 6	Beneath rear seat



**NOTE:** The earth points listed above, will not necessarily be fitted to all versions of the vehicle.



## EARTH POINTS AND HEADER JOINTS

---

### Earth Headers

There is one Earth Header attached to the inner wing abutment bracket located in the left hand side of the engine compartment.

<b>Connector No</b>	<b>Title</b>	<b>Location</b>
C550	Earth header 1	LH side of engine compartment

### ANTI-THEFT ALARM OPERATION

The alarm system can only be armed and disarmed by using the handset



**NOTE: Subsequent unlocking of the vehicle using the key will activate the alarm. Locking the driver's or front passenger's door with the key will NOT arm the alarm.**

The system features:

- a perimetric alarm (protects access to the passenger, engine and luggage compartments).
- engine immobilisation.

Battery voltage to the alarm is supplied from fuse B6 in the passenger compartment fuse box on a P wire and earth is on a B wire. The alarm also receives battery voltage on a W wire from fuse A4 in the passenger compartment fuse box providing the starter switch is in position II. The anti-theft alarm indicator light receives battery voltage from fuse C4 in the passenger compartment fuse box on a PO wire and a control signal on a YN wire from the alarm ECU.

### Handset

A coded radio signal is transmitted from the handset when either button is pressed. The RH (padlock symbol) button is used to arm the alarm and use of the LH button disarms it. Provided the handset is operated in the proximity of the vehicle, the signal is received on the aerial and passed to the alarm ECU on a WY wire.

When the alarm is armed, the anti-theft alarm indicator light flashes rapidly for approximately 10 seconds and then continues at a slower rate as a visual deterrent. If a door or the bonnet is not properly closed, the alarm will be armed and the engine immobilised. The anti-theft alarm indicator light will not flash for approximately 10 seconds, it will then flash slowly to indicate that the system is only partially armed and to provide a visual anti-theft deterrent. When the open door or the bonnet is closed, the alarm will become fully armed.

## DESCRIPTION AND OPERATION

---

Each time the handset button is pressed, the radio signal code is changed in a sequence mirrored by the receiver in the alarm ECU. If the sequence is broken, (e.g. by handset battery renewal, or by temporary vehicle battery disconnection, etc.), it will be necessary to restore synchronisation. This can be done by pressing the handset RH button four times in quick succession, until the vehicle responds by arming the alarm.

### **Perimetric alarm**

The perimetric alarm can only be set using the handset. Each door, the bonnet and the luggage compartment incorporates a switch that closes as the aperture is opened. When a switch is closed, an earth signal is sent to the alarm ECU on a PW wire for the driver and passenger doors, on a PK wire for the boot and on a PR wire for the bonnet.

If a door is opened when the alarm is armed, the alarm ECU sends an earth on a PB wire to one side of the horn relay coil. Since the other side of the coil receives battery voltage on a P wire from fuse B6 in passenger compartment fuse box, the relay will energise causing the horn to sound. Once triggered, the horn will sound for a period of approximately 30 seconds - it can be silenced by pressing the plain button on the handset.

### **Engine immobilisation**

The engine is immobilised when the perimetric alarm is set, inhibiting the engine primary electrical circuits. Immobilisation is removed when the LH handset button is pressed. The alarm ECU provides an earth on a WR wire (via the automatic inhibitor switch on a WLG wire in the case of vehicles fitted with an automatic gearbox) to one side of the starter relay coil. Since the other side of the coil is receiving battery voltage from fuse C8 the passenger compartment fuse box on a WR-WK wire, the relay is energised. Once this occurs, battery voltage is switched from link 4 in the engine compartment fuse box on an N wire via the MEMS relay module to the starter motor on an NR wire, with an immobilisation signal being sent to the MEMS ECM on a WS wire.

### **Passive engine immobilisation**

Even if the car is not locked, the passive immobilisation feature will be enabled approximately 30 seconds after the starter switch is turned to the 'OFF' position and the driver's door has been opened. This state is indicated by the anti-theft alarm indicator light flashing. While the door is open, the anti-theft alarm indicator light illuminates continuously.

In this condition, the engine can be re-mobilised by pressing the LH button on the handset before operating the starter switch.

### **Handset battery replacement**

Dependent on usage, the CR2032 type battery in the handset should last for three years. When the battery is near the end of its life, a reduction in the operating range of the handset may be noticed. To change the battery, first carefully prise open the handset casing at the key ring end, taking care not to damage the seal. Slide the battery out, without bending the clip or touching any of the contact surfaces. Press and hold each handset button for five seconds, to allow residual power to discharge.

Without touching the contact surfaces, carefully slide a new battery into the clip, ensuring that the side marked '+' faces the clip. Snap together the two halves of the handset case.

Unlock the car then operate the RH (lock symbol) button at least four times, to resynchronise the handset to the car. The handset is now ready for use.

### **Vehicle battery**

Always disarm the alarm BEFORE the battery terminals are disconnected. Failure to do this will result in the alarm sounding as soon as the battery is reconnected.

## DESCRIPTION AND OPERATION

---

### **HORNS OPERATION**

The horn receives a direct earth on a B wire.

Battery voltage is supplied from fuse B6 in the passenger compartment fuse box on a P wire to the horn relay contacts and one side of the coil. When the horn push switch is operated the other side of the relay coil receives an earth on a PB wire via the rotary coupler. The alarm ECU will also supply an earth path to the horn relay coil on a PB wire when the integrity of the alarm system is broken.

When the relay coil receives the earth it is energised, switching battery voltage from B6 in the passenger compartment fuse box on a P wire via the closed contacts of the relay to the horn on a PB wire. Since the other side of the horn is connected to earth, the horn will sound.

### **SUNROOF OPERATION**

The sunroof switches receive an earth supply on an N wire and, providing the starter switch is in position I or II, battery voltage is supplied on an R wire from fuse B7 in the passenger compartment fuse box. Operating the rear-mounted switch causes the sunroof to open, and operating the front-mounted switch causes the sunroof to close.

The sunroof motor operation and hence sunroof movement is controlled by operation of these switches. When the sunroof is in the closed position, the two switches provide an earth path to both motor terminals on B and S wires.

Operation of switch I supplies battery voltage on a B wire to one of the terminals of the sunroof motor. Since the second terminal is connected on a S wire to earth, the motor will operate and will continue until the switch is released.

Operation of switch II supplies battery voltage on a S wire to the second terminal of the sunroof motor. Since the first terminal is connected on a B wire to earth the motor will operate, and will continue until the switch is released.

## DESCRIPTION AND OPERATION

---

### CHARGING AND STARTING SYSTEM OPERATION

#### Charging system

The charging system is an alternator that contains a rectifier pack and regulator to maintain a constant direct current (dc) voltage in the system. The alternator has a fixed coil wound stator in which a field coil rotor rotates. Slip rings conduct current to and from the field coils via two carbon brushes. The unit is machine sensed, the regulator senses output voltage and regulates this to a maximum of 14 volts. The alternator is belt driven from the crankshaft and cooled by a fan mounted behind the pulley.

When the starter switch is switched on, a small current flows through the ignition/no charge warning lamp then to the field windings, partially magnetising the rotor and then passes to earth via the brushes and regulator. The warning lamp circuit is complete and the bulb glows. When the engine is started, the magnetised rotor turns within the stator windings generating 3-phase alternating current (ac) and voltage that rises rapidly with rotor speed. The rotor produces ac by virtue of the magnetic field of the rotor relative to the stator.

The field diodes in the rectifier pack convert the full wave ac current into dc. Output current from the field diodes supplements the initial current flowing through the field windings, causing an increase in the magnetic influence of the rotor resulting in self-excitation of the alternator. The field current increases with rotor speed and thus increases generated current and voltage until the alternator is fully-excited.

When the voltage applied to the alternator side of the warning lamp exceeds battery voltage the warning lamp is extinguished indicating that the alternator is developing battery-charging current. The regulator functions as an electronic control switch on the earth side of the field coils, rapidly switching the earth circuit OFF and ON to maintain the maximum voltage and thus the current to safe limits.

When the battery is in a low stage of charge or the current draw from electrical units causes voltage drop, the alternator automatically charges at its maximum rate (dependent on speed) until 14 volts is reached. When the demand on the alternator falls, the current output is reduced.

### **Starting system**

When the starter switch is turned to the crank position, battery voltage is switched via fuse C8 in the passenger compartment fuse box to one side of the starter relay coil on a WR-WK wire. The other side of the coil is earthed differently dependent on model :

#### ***MPI***

Manual vehicles receive an earth from the alarm ECU on a WR wire;  
Automatic vehicles receive an earth on a WLG wire via the automatic inhibitor switch from the alarm ECU on a WR wire.

#### ***SPI***

Manual vehicles are earthed directly on a B wire;  
Automatic vehicles are earthed on a WLG wire via the automatic inhibitor switch and a B wire.

When the starter relay is energised, battery voltage on an N wire from link 4 in the engine compartment fuse box is switched to the starter motor solenoid on an NR wire. Since the other side of the starter relay is connected to earth, the starter solenoid energises and applies direct battery voltage on an R wire (MPI only) or a B wire (SPI only) to the starter motor. Earth to the starter motor is via the mountings.



## DESCRIPTION AND OPERATION

---

### **MODULAR ENGINE MANAGEMENT SYSTEM (MEMS)**

MEMS is controlled by the MEMS control unit (ECM) which is located in the RH front corner of the engine compartment or on the RH inner wing valance, according to model.

The ECM is an adaptive unit, which means that, over a period of time, it can 'learn' the load and wear characteristics of the engine. Because no two engines have identical characteristics, this information is needed by the ECM to determine the amount of stepper motor movement required to achieve the specified idle speed.

The features of MEMS are:

1. One common ECM is utilised, incorporating a programmed ignition system and a fuel injection system.
2. A separate diagnostic socket facilitates diagnosis of the system and engine tuning using 'TestBook' without disconnecting the ECM harness multiplug. The diagnostic socket receives and transmits appropriate signals to and from the ECM on a WY wire.
3. The ECM incorporates short circuit protection and has powerful diagnostic capabilities with the ability to store intermittent faults on certain inputs. These capabilities are fully utilised by the programmable TestBook.
4. The ignition system is used to improve the idle speed response, and by advancing or retarding the ignition when load is placed on, or removed from the engine.
5. If certain system inputs fail, the ECM implements a back-up facility enabling the system to carry on functioning, although at a reduced level of performance.

### **PROGRAMMED IGNITION SYSTEM**

MEMS incorporates a programmed ignition system, the timing being controlled using digital techniques instead of the conventional mechanical and vacuum advance mechanisms.

The ECM determines the correct ignition timing by receiving signals from the following:

1. Crankshaft position sensor (crankshaft position and engine speed)
2. Camshaft position sensor (camshaft position and cam period)
3. Manifold absolute pressure sensor (engine load)
4. Engine coolant temperature sensor (engine temperature)
5. Throttle position sensor

Timing is controlled by the ECM which is energised by the main relay, located within the relay module. Spark distribution is achieved by a direct ignition system which consists of an ignition coil driven directly by the ECM. The twin-ignition coil is mounted on the front of the engine and has a primary winding resistance of 0.63 to 0.77 ohms at 20°C, which allows full h.t. output to be attained sooner thus making coil operation more consistent throughout the engine speed range.

### ***MEMS ECM***

The ignition sense of the ECM receives battery voltage from fuse A4 in the passenger compartment fuse box on a W wire provided the starter switch is in position II. As a result the ECM supplies an earth from the main relay control on a WK wire to one side of the main relay coil (within the MEMS relay module). Since the other side of the main relay receives battery voltage on an N wire from link 4 in the engine compartment fuse box, the relay will energise switching battery voltage via the relay contacts on an NK wire to the injector(s), purge valve, stepper motor, ignition coil, manifold heater (Japan only) and positive feed to the ECM.

## DESCRIPTION AND OPERATION

---

### ***Crankshaft position (CKP) sensor***

The speed and position of the engine are detected by the crankshaft position (CKP) sensor which projects through the engine adapter plate. A critical air gap exists between the CKP sensor and the flywheel, which is essential to allow correct engine operation.

The flywheel incorporates a reluctor ring which consists of 32 poles spaced at 10° intervals, with 4 missing poles at 30° , 60° , 210° and 250° . The missing poles inform the ECM when to operate the injectors, with the remaining poles providing a continual update of crankshaft position and engine speed. As the flywheel rotates, each pole that passes the CKP sensor disturbs the magnetic field created by the sensor inducing a voltage pulse in the coil. The CKP sensor is monitored by the ECM on UP and WU wires.

### ***Camshaft position (CMP) sensor***

The camshaft position sensor has two functions; the first is to enable the ECM to run a sequential fuelling mode; the second is to measure the actual cam period, this measurement is achieved using teeth on the camshaft to indicate when the valve opens and closes. The CMP sensor is monitored by the ECM on BU and RY wires.

### ***Manifold absolute pressure (MAP) sensor***

The manifold absolute pressure sensor is mounted directly on the inlet manifold and provides the ECM with an accurate representation of the load placed on the engine. This allows the ECM to adjust the quantity of fuel being injected together with the ignition timing, to achieve optimum fuelling of the engine. The MAP sensor achieves this by detecting pressure variations inside the manifold, then converting these variations into graduated electrical signals which are monitored by the ECM on RG and YP wires to determine engine load. Earth supply is on a KB wire.

### ***Engine coolant temperature (ECT) sensor***

The engine coolant temperature (ECT) sensor is located on the coolant outlet elbow. It is a temperature dependent resistor (thermistor), the voltage output of which varies in inverse proportion to temperature, in that the output increases as temperature decreases or the reverse. The change in resistance is monitored by the ECM on a KG wire and as a result the ECM can adjust the length of injector opening time required. The ECM supplies the coolant temperature sensor with an earth path on a KB wire.

### ***Manifold heater (Japan only)***

One side of the manifold heater relay coil receives battery voltage from link 4 in the engine compartment fuse box via the closed contacts of the main relay (providing it is energised). The other side of the relay coil receives a control earth on a BK wire from the link 4 in the engine compartment fuse box via the closed contacts of the relay to the manifold heater.

### ***Throttle position sensor***

The throttle position (TP) sensor is a potentiometer attached to the throttle housing and is directly coupled to the throttle disc. Closed throttle is detected by the TP sensor which initiates idle speed control via the idle air control valve (IACV).

The TP sensor receives a 5 volt supply from the ECM on a YP wire and is supplied with an earth on a KB wire. The sensor then provides a signal which is proportional to throttle disc position on a YG wire to the ECM.

### ***Idle speed control***

With the throttle pedal released and the engine at idle, the ECM maintains stable idling performance by using the fast response of the engine to changes in ignition timing. According to the loads placed on or removed from the engine, the ECM responds to changes in engine speed and, together with adjustments to the idle air control valve (IACV), advances or retards the ignition timing to achieve a constant idling speed. When load is removed from the engine, the IACV returns to its original position and the ignition timing reverts to the idle setting.



**NOTE: Due to the sensitivity of this system the ignition timing will be constantly changing at idle speed.**

### **FUEL INJECTION SYSTEM**

MEMS injection system incorporates one (on SPI version) or two (on MPI version) injectors which are located between the pressurised fuel rail and the inlet manifold. The injectors are solenoid operated and direct a spray of fuel into the inlet manifold onto the back of the inlet valves.

The amount of fuel injected is determined by how long the injector is held open (known as the injector pulse width). To achieve the required air fuel ratio the ECM receives signals from the following inputs:

1. Crankshaft position sensor (engine speed).
2. Camshaft position sensor (camshaft position and cam period).
3. Manifold absolute pressure sensor (engine load).
4. Intake air temperature sensor (inlet air temperature).
5. Engine coolant temperature sensor (engine temperature).
6. Throttle position sensor (rate of throttle opening or throttle closed position).
7. Battery voltage (state of battery charge).
8. Heated oxygen sensor (oxygen content of exhaust gases).

### ***Idle air control valve (stepper motor)***

The idle air control valve (IACV) is mounted on the inlet manifold. It receives battery voltage on an NK wire via the main contacts and is controlled by the ECM on OS (phase 1), KU (phase 2), OG (phase 3), and OU (phase 4) wires and receives an earth supply on a KB wire. During cold starting, the ECM provides a fast idle by sending a signal to the IACV which opens a pintle valve situated inside an air passage within the throttle housing. This allows air to bypass the throttle disc and flow directly into the inlet manifold. As the engine coolant temperature rises the fast idle is reduced until normal idle speed is attained.

### ***Intake air temperature sensor***

The intake air temperature (IAT) sensor is located on the side of the inlet manifold. The IAT sensor is of the negative temperature coefficient (NTC) type, reducing its resistance with increases in air temperature. The ECM monitors the IAT sensor on a GB wire and is supplied with an earth on a B wire. When the ECM receives a signal from the sensor, it uses the signal along with that from the MAP sensor to calculate the volume of oxygen in the air and carry out fine adjustments of the injected fuel to attain the optimum mixture strength.

## **Catalytic Converter System**

### ***Heated oxygen sensor***

The heated oxygen sensor (HO2S) is part of a closed loop-type exhaust emission system. The sensor is fitted in the exhaust manifold and is designed to monitor the exhaust gases. In weak air/fuel mixtures, oxygen content in the exhaust gas increases, decreasing the voltage output to the ECM. As the air/fuel mixture becomes richer so oxygen content decreases, increasing the voltage output to the ECM.

One side of the oxygen sensor relay coil receives an earth from the ECM on a BG wire providing the starter switch is in position II. The other side of the relay coil receives battery voltage from link 4 in the engine compartment fuse box on an N wire via the contacts of the main relay (providing it is energised). As a result the oxygen sensor relay energises and battery voltage is switched from link 4 in the engine compartment fuse box on an N wire via the closed contacts of the oxygen sensor relay to the oxygen sensor on a UR wire.

## DESCRIPTION AND OPERATION

---

Since an earth is provided on a B wire, the integral heating element will quickly reach an efficient operating temperature from cold.

The resultant output voltage on the LGS and S wires is used by the ECM to determine what correction to fuel delivery is necessary.



**CAUTION: An oxygen sensor will not operate if its power supply is removed, if it has been dropped, subjected to any impact or if cleaning materials are used on it.**

### ***Purge valve***

The purge valve receives battery voltage on an NK wire from link 4 in the engine compartment fuse box on an N wire from the closed contacts of the main relay (providing it is energised) and a control signal from the ECM on a BW wire. The valve remains closed when the engine is cold and at idling speed to protect engine tune and catalyst performance. When the purge valve is open, fuel vapour from the charcoal canister is drawn into the throttle housing for combustion.

### **Automatic gearbox**

#### ***Inhibitor switch***

The switch fitted to the gearbox inhibits operation of the starter motor unless the selector lever is in position **P** or **N**.

With the selector lever in position **P** or **N** the inhibitor switch will provide an earth path for the starter relay on a BLG wire which will allow the engine to be started.

If the selector lever is in any other position than **P** or **N**, the inhibitor switch will not provide an earth path, so preventing the vehicle starting.

The inhibitor switch also provides the ECM with an input so that idle speed is automatically adjusted when a drive position is selected.

### **FUEL PUMP OPERATION**

One side of the fuel pump relay coil receives battery voltage from fuse A4 in the passenger compartment fuse box on a W wire provided the starter switch is in position II. The other side of the relay coil receives an earth on a BP wire from the MEMS control unit provided the correct operating conditions exist, (see Engine Management System) causing the relay to energise.

The energised relay switches battery voltage from link 4 in the engine compartment fuse box on an N wire, via fuse C7 in the passenger compartment fuse box to the inertia fuel shutoff switch on an NS wire. Provided the inertia fuel shutoff switch remains closed, battery voltage is fed on a WP wire to the fuel pump. Since the pump has a permanent earth on a B wire it will commence operation.



### **BRAKE FLUID LEVEL WARNING OPERATION**

The system provides a visual warning if the fluid in the brake fluid reservoir falls below the accepted level. The brake system warning lamp consists of a 1.2 W bulb which receives battery voltage on a PO wire from fuse C4 in the passenger compartment fuse box. Under normal operating conditions the lamp will not function, but if the brake fluid level falls the displacement will close the contacts of the fluid level switch, switching an earth on a BW wire to the other side of the lamp causing it to illuminate.

#### ***Brake test switch***

When verification of the warning lamp circuit is needed, operation of the brake test switch supplies an earth via the switch on a BW wire to the warning lamp, causing it to illuminate.

### SRS (AIRBAG) OPERATION



**NOTE: The airbag control unit (DCU) is a non-serviceable component and no attempt to repair or modify the module should be made.**

The airbag control unit receives battery voltage from the starter switch via fuse B5 in the passenger compartment fuse box on a G wire. Earth to the airbag control unit is on a B wire.

In the event of an accident involving a frontal impact, a sensor situated inside the airbag control unit monitors the force of the impact to determine whether the airbag should be inflated. A safing sensor wired in series with the main sensor allows the system to discriminate between driving on roads with potholes, striking kerbs, etc., and an actual impact.

The sensors when activated supply voltage to the igniter circuit of the airbag. Grains of Nitrocellulose and Nitroglycerine inside the airbag module, ignite and combine in a chemical reaction to form a large amount of Nitrogen gas leading to inflation of the airbag in approximately 30 milli-seconds.

As the occupant moves forward into the airbag it immediately discharges the gas through a vent hole to provide progressive deceleration and reduce the risk of injuries.

A regulator circuit and a back-up power circuit are connected in parallel with the car battery. The regulator circuit increases the stability of the SRS system by raising the voltage when the battery voltage drops. The back-up power circuit provides power in the event of the battery being disconnected due to the impact.

Sequence of operation:

1. The main sensor and the safing sensor are activated.
2. Power is supplied to the airbag igniter by the battery or the back-up circuit.
3. The airbag deploys.

It takes about 0.1 second from the beginning of the airbag deployment until it is completely deflated.

## DESCRIPTION AND OPERATION

---

### ***Driver's airbag***

The driver's airbag is connected to the airbag control unit via the rotary coupler on Y and R wires.

### ***Pre-tensioners***

The right hand pretensioner is controlled by the DCU on N and NR wires.

The left hand pretensioner is controlled by the DCU on O and OU wires.

### ***SRS warning lamp***

When the starter switch is operated to position II, the warning lamp (located on the instrument panel) receives battery voltage from fuse A4 on a W wire and a control signal from the airbag control unit on a P wire. The warning lamp will illuminate when the electrical circuits are initialised while the system performs a self-diagnosis test. If the system finds no fault during self diagnosis the warning lamp will extinguish after approximately 6 seconds.

In the event of a fault in the system the warning lamp will illuminate continuously or fail to illuminate during the self diagnosis test.

### **SEAT BELT WARNING OPERATION (JAPAN ONLY)**

The rear seat belt warning lamp (located on the instrument panel) receives battery voltage from fuse A6 in the passenger compartment fuse box on a G wire, provided the starter switch is in position II . Whenever the seat belt is unlatched, the warning lamp illuminates as a result of receiving an earth on a B wire via the seat belt buckle switch on a BG wire. The seat belt buckle earth path is broken when the buckle is latched, causing the lamp to extinguish.

### **CATALYST OVERHEAT WARNING OPERATION (JAPAN ONLY)**

When the starter switch is in position II, battery voltage is switched through fuse A6 in the passenger compartment fuse box on a W wire to the catalyst overheat ECU on a G wire. Earth to the ECU is on a B wire.

If the catalyst overheat ECU detects an overheat condition, the overheat switch will operate switching battery voltage on a G wire from fuse A6 to the catalyst overheat buzzer on a BY wire. Since the buzzer has an earth connection on a GY wire from the catalyst overheat ECU, the buzzer will sound and continue to do so while the catalyst overheat condition exists.

#### ***System check***

When the starter switch is initially operated, the catalyst overheat buzzer will sound for a few seconds.

### **AIR CONDITIONING OPERATION (JAPAN)**

The air conditioning system may only be operated with the starter switch in position II. The position of the temperature control determines the threshold at which the system operates and the blower switch permits selection of four different blower motor speeds.

### ***MEMS ECM***

The thermistor monitors the temperature at the evaporator and provides feedback on S and SR wires to the A/C thermostat. Dependent on the level of cooling required the temperature control can be adjusted, providing input on YR and YB wires to the A/C thermostat. The A/C thermostat supplies an aircon request signal to the ECM on a GW wire via the dual pressure switch. The ECM responds by providing an earth on a RW wire to one side of the compressor clutch relay coil and one side of the condenser fan relay coil.

### ***Air conditioning switch and condenser fan***

When the air conditioning switch is operated, battery voltage is switched from fuse A6 in the passenger compartment fuse box on a G wire via the air conditioning switch on a GW wire to one side of the condenser fan relay coil, compressor clutch relay coil and the aircon blower relay coil (located within the relay module). As a result the compressor clutch relay energizes, switching battery voltage from fuse A6 via the relay contacts to the compressor clutch. Since the compressor clutch mounting is connected to earth, the clutch will operate to engage the compressor. The condenser fan relay is simultaneously energized when the compressor clutch relay is energized, switching battery voltage from fuse A9 on a U wire via the condenser fan relay contacts to the condenser fan on a U wire. Since the other side of the condenser fan is connected to earth, the fan will operate.

## DESCRIPTION AND OPERATION

---

### ***Aircon blower motor, switch and resistor pack***

One terminal of the aircon blower motor receives battery voltage from link 2 in the engine compartment fuse box via the starter switch, the auxiliary relay (provided it is energized) and fuse A7. When the blower switch is operated from the OFF position, an earth is switched on a UG wire to the other side of the aircon blower relay coil and simultaneously to the other terminal of the aircon blower motor via the resistor pack or direct dependent on the blower speed required. In addition, since battery voltage already exists on the aircon blower relay coil, the relay energizes, switching an earth via the relay contacts to the A/C thermostat.

Moving the blower switch from the OFF position increases the speed of the aircon blower motor incrementally as follows:

- The first position provides a connection from earth via the blower switch and blower speed switch on a UG wire and via all three resistors in the pack to the aircon blower motor terminal on a UB wire.
- The second position provides a connection from earth via the blower switch and blower speed switch on a UY wire and via two resistors to the aircon blower motor terminal on a UB wire.
- The third position provides a connection from earth via the blower switch and blower speed switch on a UR wire and via one resistor to the aircon blower motor terminal on a UB wire.
- The fourth position provides an earth path on a UB wire direct to the aircon blower motor terminal.

### ***Dual pressure switch***

**The dual pressure switch consists of a high and a low pressure switch connected in series with the aircon request signal from the A/C thermostat to the MEMS ECM. In the event of pressure deviating from the normal condition, the relevant switch will open preventing the signal reaching the ECM and thereby inhibiting the system. When the correct pressure is restored the system will resume normal operation.**

### **HEATER BLOWER OPERATION**

The heater blower assembly incorporates a 3-position switch which controls the operation of the blower motor. The blower switch allows low speed operation when position I is selected, and high speed operation when position II is selected.

The heater blower assembly receives battery voltage from link 2 in the engine compartment fuse box via the starter switch, auxiliary relay (provided the relay is energized) and fuse A8 in the passenger compartment fuse box on an LGO wire. When blower switch position I is selected, an earth is switched on a B wire via the integral blower motor resistor and the blower switch to the blower motor. Since there is a voltage drop across the resistor, the motor will operate at slow speed. When blower switch position II is selected, an earth on a B wire is switched directly to the blower motor causing the motor to rotate at full speed.



## DESCRIPTION AND OPERATION

---

### COOLING FAN OPERATION

#### ***MPI***

The cooling fan is controlled by the MEMS control unit which supplies an earth to the cooling fan relay provided operating conditions are met, see Engine Management System.

Battery voltage is supplied on an N wire from fusible link 1 in the engine compartment fuse box via fuse B9 in the passenger compartment fuse box to one side of the cooling fan relay coil on a P wire. The coolant temperature sensor provides a feedback to the MEMS control unit on a KG wire.

When the coolant temperature reaches 105°C, the MEMS control unit provides an earth to the other side of the cooling fan relay coil on an LGB wire, which causes the relay to energize. Battery voltage on the P wire is then switched from fuse B9 in the passenger compartment fuse box via the closed contacts of the cooling fan relay to the cooling fan on the BG wire. Since the other side of the cooling fan relay is connected to earth on a B wire, the fan will operate. When the temperature falls to 98°C the MEMS control unit removes the earth to the cooling fan relay coil on the LGB wire, causing the cooling fan relay to de-energize which removes the supply to the cooling fan relay.

#### ***SPI (Japan only)***

The cooling fan is an auxiliary unit which acts as a back-up for the engine driven cooling fan when the coolant temperature becomes excessive. It is controlled by the high temperature switch attached to the radiator and operates once operating conditions have been met.

One side of the cooling fan relay receives battery voltage on LGW wires from fuse B4 in the passenger compartment fuse box provided the auxiliary relay is energized. When the coolant temperature exceeds 98°C, the contacts of the high temperature switch close providing an earth to the other side of the cooling fan relay coil on an LGB wire. Battery voltage on the P wire is then switched from fuse B9 in the passenger compartment fuse box via the closed contacts of the cooling fan relay to the cooling fan on the BG wire. Since the other side of the cooling fan relay is connected to earth on a B wire, the fan will operate. When the temperature falls to 93°C the high temperature switch opens, causing the cooling fan relay to de-energize which removes the supply to the cooling fan relay.

### **HEATED REAR WINDOW OPERATION**

The heated rear window switch will only allow the heated rear window element to function when the starter switch is at position II. Fuse C9 in the passenger compartment fuse box supplies battery voltage to the heated rear window switch on a G wire. When the switch is operated, battery voltage is switched to the heated rear window element and switch illumination bulb on a GY wire. Since the other side of the element and the illumination bulb have permanent connections to earth on B wires, the bulb will illuminate and the element will commence heating.

## DESCRIPTION AND OPERATION

---

### **WINDSCREEN WIPERS AND WASHERS OPERATION**

The wiper system is a two speed system, incorporating single wipe, intermittent wipe and a screen wash/wipe facility. The normal speed is controlled directly via the column switches. The intermittent wipe, fast speed and wash/wipe are controlled by the front wiper control unit. The windscreen wipers will only operate when the starter switch at position I or II.

Provided the starter switch is in position I or II, one side of the auxiliary relay coil receives battery voltage on an LG wire from the starter switch. Since the other side of the relay coil is connected to earth, the relay will energise, switching battery voltage from fusible link 2 in the engine compartment fuse box via the relay contacts on an LGW wire to fuse B8 in the passenger compartment fuse box. Fuse B8 connects the battery voltage to the wash/ wipe switch, windscreen wiper motor and wiper control unit on an LGO wire.

#### ***Intermittent wipe***

When the intermittent option is selected, battery voltage on an LGO wire to the wiper switch is switched via the switch on an LGG to the wiper control unit. The wiper control unit provides an output on the NLG wire via the wash/wipe switch on a ULG wire to the motor slow speed terminal after a fixed delay of approximately 5 seconds. Since the other motor terminal is permanently connected to earth on a B wire, the motor will rotate causing the wiper blades to operate.

#### ***Wiper normal speed***

With the wiper switch in position I, battery voltage on an LGO wire from fuse B8 in the passenger compartment fuse box is switched via the wash/wipe low switch on a ULG wire to the motor slow speed terminal. Since the other motor terminal is permanently connected to earth on a B wire, the motor will rotate causing the wiper blades to operate.

#### ***Wiper fast speed***

With the wiper switch in position II, battery voltage on an LGO wire from fuse B8 in the passenger compartment fuse box is switched via the wash/wipe high switch on a RLG wire to the motor fast speed terminal. Since the other motor terminal is permanently connected to earth on a B wire, the motor will rotate causing the wiper blades to operate.

### ***Single wipe***

When the right-hand steering column lever is pressed down momentarily, battery voltage is switched on an LGO wire from fuse B8 in the passenger compartment fuse box via the front wash/wipe switch on an RLG wire to the motor fast speed terminal. Since the other motor terminal is permanently connected to earth on a B wire, the motor will rotate causing the wiper blades to operate.

The wipers perform a single operation and if the lever is held in the down position, the wipers will continue to operate.

### ***Wash/wipe***

When the wash switch is operated, battery voltage on an LGO wire is switched from fuse B8 in the passenger compartment fuse box on an OR wire to one terminal of the washer pump. Since the other washer pump terminal is permanently connected to earth on a B wire, the pump will dispense water to the screen. Simultaneously the front wiper control unit receives battery voltage on an OR wire. The front wiper control unit responds by supplying battery voltage on an NLG wire via the wash/wipe low switch to the wiper motor slow speed terminal on a ULG wire. Since the other motor terminal is permanently connected to earth on a B wire, the motor will rotate causing the wiper blades to operate.

### ***Wiper motor park***

The integral wiper motor park switch is designed to switch battery voltage from fuse B8 in the passenger compartment fuse box on an LGO wire to the front wiper control unit on an NLG wire. This ensures that, when the wash/wipe switch is turned to the OFF position, the wiper control unit responds by supplying battery voltage on an NLG wire via the wash/wipe low switch to the wiper motor slow speed terminal on a ULG wire. This returns the park switch to the rest position.

## DESCRIPTION AND OPERATION

---

### EXTERIOR LIGHTS

#### **Brake lamps operation**

When the brake pedal is operated, battery voltage on a G wire from fuse C6 in the passenger compartment fuse box is switched on GP wires to the brake lamps. Since the other side of the lamps are permanently connected to earth on B wires the lamps will illuminate.

#### **Reverse lamps operation**

When reverse gear is selected battery voltage on a G wire from fuse C6 in the passenger compartment fuse box is switched on GN wires to the reverse lamps. Since the other side of the lamps are permanently connected to earth on B wires the lamps will illuminate.

### EXTERIOR LIGHTS

#### Head, side, tail and number plate lamps operation

##### Headlamps

###### *Dipped beam*

The lighting switch common receives battery voltage on an N wire from fusible link 3 in the engine compartment fuse box.

Provided the dip/main switch is in the 'DIP' position, operation of the lighting switch to position II, switches battery voltage on a UR wire to fuses A2 and C2 in the passenger compartment fuse box. Battery voltage is switched from fuse A2 to the RH dip lamp on a UR wire and from fuse C2 to the LH dip lamp on a UR wire. Since the other side of the lamps are permanently connected to earth on B wires the lamps will illuminate.

###### *Main beam*

The lighting switch common receives battery voltage on an N wire from fusible link 3 in the engine compartment fuse box.

Provided the dip/main switch is in the 'MAIN' position, operation of the lighting switch to position II, switches battery voltage on a UW wire to fuses A1 and C1 in the passenger compartment fuse box. Battery voltage is switched from fuse A1 to the RH main lamp on a UW wire and from fuse C1 to the LH main lamp on a UW wire. Since the other side of the lamps are permanently connected to earth on B wires the lamps will illuminate.

###### *Headlamp flash*

The lighting switch common receives battery voltage on an N wire from fusible link 3 in the engine compartment fuse box.

Regardless of the position of the dip/main switch or the lighting switch, operation of the headlamp flash switch switches battery voltage on a UW wire to fuses A1 and C1 in the passenger compartment fuse box. Battery voltage is switched from fuse A1 to the RH main lamp on a UW wire and from fuse C1 to the LH main lamp on a UW wire. Since the other side of the lamps are permanently connected to earth on B wires the lamps will illuminate for as long as the headlamp flasher switch remains closed.

## DESCRIPTION AND OPERATION

---

### ***Side and tail lamps***

The lighting switch common receives battery voltage on an N wire from fusible link 3 in the engine compartment fuse box.

Operation of the lighting switch to position I, switches battery voltage on an R wire to fuses A3 and C3 in the passenger compartment fuse box. Battery voltage is switched from fuse A3 to the RH side and tail lamps on RW wires and from fuse C3 to the LH side and tail lamps on RB wires. Since the other side of the lamps are permanently connected to earth on B wires the lamps will illuminate.

### ***Number plate lamps***

The lighting switch common receives battery voltage on an N wire from fusible link 3 in the engine compartment fuse box.

Operation of the lighting switch to position I, switches battery voltage on an R wire to fuse C3 in the passenger compartment fuse box. Battery voltage is switched from fuse C3 to the LH side and tail lamps on RB wires, and to the number plate lamps on RB-R wires. Since the other side of the lamps are permanently connected to earth on B wires the lamps will illuminate.

### EXTERIOR LIGHTS

#### Front fog and driving lamps operation

##### *Front fog lamps*

Provided the lighting switch is in position II, battery voltage is switched from fusible link 3 in the engine compartment fuse box on an N wire via the lighting switch on an R wire to fuse C3 in the passenger compartment fuse box.

Operation of the front fog lamp switch supplies battery voltage on an RB wire from fuse C3 in the passenger compartment fuse box via the front fog lamp switch on a UG wire to one side of the front fog lamp relay coil. Since the other side of the relay coil is connected to earth, the relay energises and switches battery voltage from the stand-alone fuseholder on a PU wire and via the front fog lamp relay contacts on UG wires to both fog lamps. Since the other side of the lamps are permanently connected to earth on B wires the lamps will illuminate.

##### *Driving lamps*

Provided the lighting switch is in position II, battery voltage is switched from fusible link 3 in the engine compartment fuse box on an N wire to the lighting switch. When the 'MAIN' position is selected on the dip/main switch, battery voltage on a UW wire is switched via fuse A1 in the passenger compartment fuse box to one side of the driving lamp relay coil on a UW wire. Since the other side of the relay coil is connected to earth, the relay energises and switches battery voltage on a P wire from fuse B1 in the passenger compartment fuse box via the relay contacts to the driving lamps on UY wires. Since the other side of the lamps are permanently connected to earth on B wires the lamps will illuminate.



## DESCRIPTION AND OPERATION

---

### EXTERIOR LIGHTS

#### Front fog and driving lamps operation (Japan)

##### *Front fog lamps*

Provided the lighting switch is in position II, battery voltage is switched from fusible link 3 in the engine compartment fuse box on an N wire via the lighting switch on an R wire to fuse C3 in the passenger compartment fuse box.

Operation of the front fog lamp switch supplies battery voltage on an RB wire from fuse C3 in the passenger compartment fuse box via the front fog lamp switch on a UG wire to one side of the front fog lamp relay coil. Since the other side of the relay coil is connected to earth, the relay energises and switches battery voltage from the stand-alone fuseholder on a PU wire via the closed contacts of the front fog lamp relay on UG wires to both fog lamps. Since the other side of the lamps are permanently connected to earth on B wires the lamps will illuminate.



**NOTE: With the lighting switch at position II, operation of the front fog lamp switch will remove battery voltage from the driving lamp relay coil, de-energising the relay which removes battery voltage from the driving lamps.**

##### *Driving lamps*

Provided the lighting switch is in position II, battery voltage is switched from fusible link 3 in the engine compartment fuse box on an N wire to the lighting switch. When the 'MAIN' position is selected on the dip/main switch, battery voltage on a UW wire via fuse A1 in the passenger compartment fuse box is switched to the front fog lamp switch on a UW-UB wire. Provided the fog lamp switch is in the 'OFF' position, battery voltage is switched on a UW wire to one side of the driving lamp relay coil. Since the other side of the relay coil is connected to earth, the relay energises and switches battery voltage on a P wire from fuse B1 in the passenger compartment fuse box via the relay contacts to the driving lamps on UY wires. Since the other side of the lamps are permanently connected to earth on B wires the lamps will illuminate.



**NOTE: Operation of the front fog lamp switch will remove battery voltage from the driving lamp relay coil, de-energising the relay which removes battery voltage from the driving lamps.**

### EXTERIOR LIGHTS

#### **Rear fog lamps operation**

The rear fog lamps will only function when the lighting switch is in position II. When the rear fog lamp switch is operated, battery voltage is switched on a UO wire from fuse B2 in the passenger compartment fusebox to the fog lamps on UY wires. Since the other side of the lamps are permanently connected to earth on B wires the lamps will illuminate.

## DESCRIPTION AND OPERATION

---

### EXTERIOR LIGHTS

#### **Headlamp levelling operation**

To prevent dazzle to oncoming vehicles the headlamps can be adjusted by a switch located on the fascia. When an increased load is placed on the rear of the vehicle raising the front, it is possible to move the headlamps to one of four positions. Battery voltage is supplied from the lighting switch via fuse B3 in the passenger compartment fuse box on an R wire to the headlamp levelling switch and both headlamp levelling motors. Earth paths are on B wires. The headlamp levelling units, fitted to the back of each headlamp, adjust position in response to voltage changes sensed at the levelling switch.

#### ***Headlamp levelling switch***

When the headlamp levelling switch is operated it switches in different value resistors dependent on the position selected. This provides the headlamp levelling motor with one of four different voltages on UG wires. The levelling motor uses internal electronics to compare the voltage from the switch with the battery voltage from fuse B3 on an R wire. Dependent on the difference between the two figures, since both headlamp levelling motors have one terminal permanently connected to earth on B wires, the headlamp moves to a set position.

<b>Switch Position</b>	<b>Vehicle load</b>
0	Driver alone or both front seats occupied (luggage compartment empty)
1	All seats occupied (no luggage)
2	All seats occupied PLUS luggage
3	Driver alone PLUS full luggage compartment

### INDICATORS AND HAZARD SYSTEM OPERATION

#### **Indicators**

The indicators will only operate when the starter switch is in position II, the hazard system will operate irrespective of the starter switch position.

With the starter switch in position II, battery voltage on a G wire from fuse C6 in the passenger compartment fuse box is supplied to one side of the direction indicator relay coil on a G wire. Since the other side of the relay coil is connected to earth, the relay will energise providing a path to the common of the direction indicator switch on an LGN wire from the direction indicator/hazard warning unit on an LGK wire.

#### ***Right***

When the direction indicator switch is moved to indicate a right turn, a pulsed voltage from the direction indicator/hazard warning unit on an LGK wire is switched via the direction indicator relay contacts on an LGN wire to the direction indicator switch common. The direction indicator switch re-directs the pulsed voltage on a GW wire to the RH front and rear indicator lamps, side repeater lamps and the direction indicator warning lamp in the instrument pack. Since the other side of the lamps are permanently connected to earth on B wires they will flash simultaneously.

#### ***Left***

When the direction indicator switch is moved to indicate a left turn, a pulsed voltage from the direction indicator/hazard warning unit on an LGK wire is switched via the direction indicator relay contacts on an LGN wire to the direction indicator switch common. The direction indicator switch re-directs the pulsed voltage on a GR wire to the LH front and rear indicator lamps, side repeater lamps and the direction indicator warning lamp in the instrument pack.. Since the other side of the lamps are permanently connected to earth on B wires they will flash simultaneously.

## DESCRIPTION AND OPERATION

---

### **Hazard warning**

When the hazard warning switch is operated, pulsed voltage is switched on an LGK wire from the direction indicator/hazard warning unit on LGK wires to the hazard warning switch. The switch contacts simultaneously connect the pulsed voltage on GR and GW wires to the front and rear indicator lamps, side marker lamps and both instrument pack warning lamps. In addition, the pulsed voltage is switched on an LGG wire to the integral hazard warning lamp. Since the other side of the lamps are permanently connected to earth on B wires the action of the direction indicator/hazard warning unit causes all the connected lamps to flash in unison.

### **INTERIOR LAMP CIRCUIT OPERATION**

Interior illumination consists of a lamp located in the headlining above the LH 'B' post which operates when either door is opened.

The interior lamp unit receives a supply from fuse C4 in the passenger compartment fuse box on a PO wire.

Under normal circumstances when either the driver's or passenger's door is opened, the door switch contacts will open providing an earth path to the interior lamp unit on the PW wire which will cause the lamp to illuminate.

When the interior light switch is operated, the lamp will illuminate as a result of the earth connection on the B wire.

## DESCRIPTION AND OPERATION

---

### INTERIOR ILLUMINATION

When the lighting switch is operated battery voltage is switched from link 3 on an N wire via the lighting switch on an R wire to fuse A3 in the passenger compartment fuse box. Fuse A3 supplies battery voltage on RW wires to the clock and instrument pack. Where applicable fuse A3 also supplies battery voltage on RW wires to the oil temperature gauge, voltage gauge and air conditioning switch pack. Since the other side of the lamps are permanently connected to earth on B wires the lamps will illuminate.

To ensure an even spread of light for panel illumination, three 2.2 W bulbs are fitted in the instrument pack while the clock, oil temperature gauge and voltage gauge are fitted with 2.2 W bulbs. A single 1.2 W bulb is fitted inside the air conditioning switch pack (Japan only).

On vehicles fitted with an automatic gearbox, provided the starter switch is at position I battery voltage is switched from link 2 on an N wire via the starter switch on an LG wire to one side of the auxiliary relay coil. Since the other side of the relay is permanently connected to earth, the auxiliary relay will energise switching battery voltage from link 2 on an N wire via the relay contacts on an LGW wire to fuse B4 in the passenger compartment fuse box.

Fuse B4 supplies a single 2.2 W bulb inside the automatic gearbox selector indicator lamp on an LGW wire. Since the other side of the lamp is permanently connected to earth on a B wire the lamp will illuminate.

### **INSTRUMENT PACK OPERATION**

The main power source for the instrument pack is from fuse link 2 in the engine compartment fuse box via the starter switch and fuse A4 in the passenger compartment fuse box on a W wire. The earth path is on a B wire.

### **Coolant temperature gauge**

The temperature gauge receives stabilised voltage from the stabiliser unit and a signal on a GU (Spi) or KG-GU (Mpi) wire from the MEMS control unit which reflects the temperature detected by the coolant temperature sensor.

### **Fuel Gauge**

The fuel gauge receives stabilised voltage from the stabiliser unit. The gauge pointer deflects dependent on the resistance between the GB connection at the sender unit and earth representing the quantity of fuel in the tank. The earth path to the sender unit is on a B wire.

When the sender unit float is at its lowest point, indicating an empty fuel tank, the resistance to earth is at its greatest value. The resistance value to fuel gauge position is:

<b>Sender resistance</b>	<b>Fuel gauge position</b>
270 ohms	Empty
67 ohms	Half full
15.5 ohms	Full

### **Clock**

The analogue clock has a permanent earth on a B wire and while the starter switch is in position O, battery voltage is supplied from fuse C4 on a PO wire.



## DESCRIPTION AND OPERATION

---

### **Ignition/no charge warning lamp**

The ignition/no charge warning lamp receives an ignition supply from fuse A4 on a W wire and is connected to the alternator on an NY wire. The lamp will illuminate if the voltage it receives on an NY wire is less than battery voltage i.e. the alternator is not supplying sufficient voltage to charge the battery.

### **Oil pressure warning lamp**

Battery voltage is supplied from fuse A4 to the oil pressure warning lamp on a W wire. When oil pressure drops below a set level, the contacts in the oil pressure switch are closed. This provides a path to earth for the warning lamp on a WN wire causing it to illuminate.

### **Indicator warning lamps**

These warning lamps give a visual indication when the direction indicators or hazards lamps are operated. The indicator circuit provides a pulsed voltage to the LH warning lamp on a GR wire or the RH warning lamp on a GW wire from the direction indicator switch.

### **Main beam warning lamp**

Gives an indication that the headlamps are being operated on main beam by switching battery voltage to the lamp on a UW wire via fuse A1 in the passenger compartment fuse box. Since the other side of the lamp is permanently connected to earth on a B wire the lamp will illuminate

### **Airbag warning lamp**

The airbag warning lamp receives battery voltage from fuse A4 on a W wire and a control signal from the airbag control unit on a P wire. The warning lamp will illuminate for approximately six seconds when the starter switch is turned to position II before extinguishing. There is a system fault when any of the following symptoms are observed:

- The warning lamp fails to illuminate when the starter switch is turned to position II.
- The warning lamp fails to extinguish after approximately six seconds.
- The warning lamp flashes or illuminates continuously while the car is being driven.

### **Tachometer**

The tachometer receives battery current from fuse A4 in the passenger compartment fusebox on a W wire. The gauge pointer will deflect dependent on the signal received from the ignition coil on a WB wire.

### **Voltage gauge**

The voltage gauge receives battery voltage from fuse A4 in the passenger compartment fuse box on a W wire providing the starter switch is in position II. The other side of the gauge is connected to earth on a B wire. The gauge pointer will deflect to indicate the condition of the battery.

### **Oil temperature gauge**

The oil temperature gauge receives battery voltage from fuse A4 in the passenger compartment fuse box on a W wire providing the starter switch is in position II. The gauge pointer will deflect dependent on the resistance between the NU connection at the oil temperature sensor and earth representing the temperature of the oil. The earth path to the sensor is on a B wire.

## DESCRIPTION AND OPERATION

---

### **IN-CAR ENTERTAINMENT OPERATION**

Provided the starter switch is at position I battery voltage is switched from link 2 on an N wire via the starter switch on an LG wire to one side of the auxiliary relay coil. Since the other side of the relay is permanently connected to earth, the auxiliary relay will energise switching battery voltage from link 2 on an N wire via the relay contacts on an LGW wire to fuse B4 in the passenger compartment fuse box.

Fuse B4 supplies battery voltage to the radio cassette player on an LGW wire.

Battery voltage is also supplied from fusible link 1 in the engine compartment fuse box on the N wire to fuse C4 in the passenger compartment fuse box. The PO wire from fuse C4 is a permanent feed to the radio which enables it to retain its preset station memory when the starter switch is in the 'OFF' position. The B wire provides an earth for the radio.

The radio and cassette player audio outputs are fed directly to the speakers; the LH rear speaker on UB and UK wires, and the RH speaker on SK and SB wires.

**(GB)**

LH front direction indicator lamp  
 Female  
 BLACK  
 Behind LH headlamp

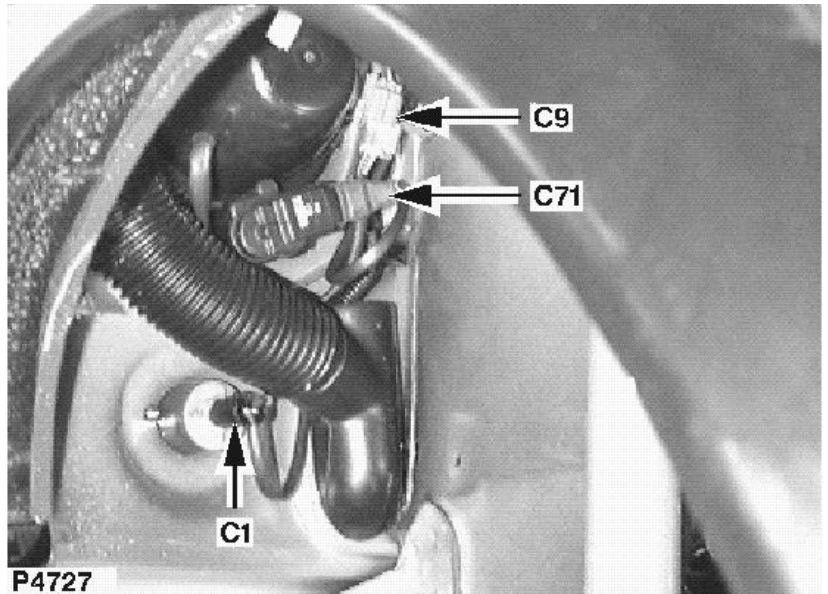

**(NL)**

Linker voorste  
 richtingaanwijzer - gloeilamp  
 Vrouwelijk  
 ZWART  
 Achter linker koplamp

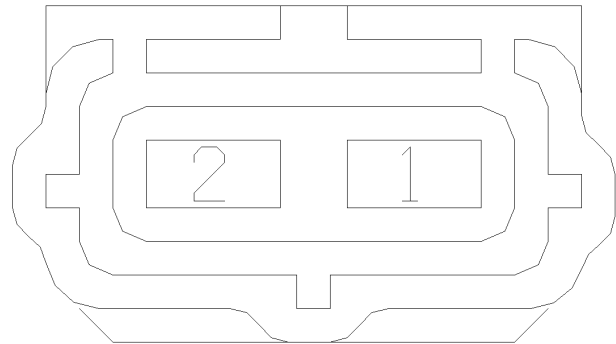

**(E)**

Luz intermitente de dirección  
 delantera izquierda  
 Hembra  
 NEGRO  
 Detrás del faro izquierdo

Cav	Col	Cct
1	GR	ALL
2	B	ALL

# C2

## CONNECTOR / AANSLUITING / CONECTOR

(GB)

RH front direction indicator  
lamp  
Female  
BLACK  
Behind RH headlamp

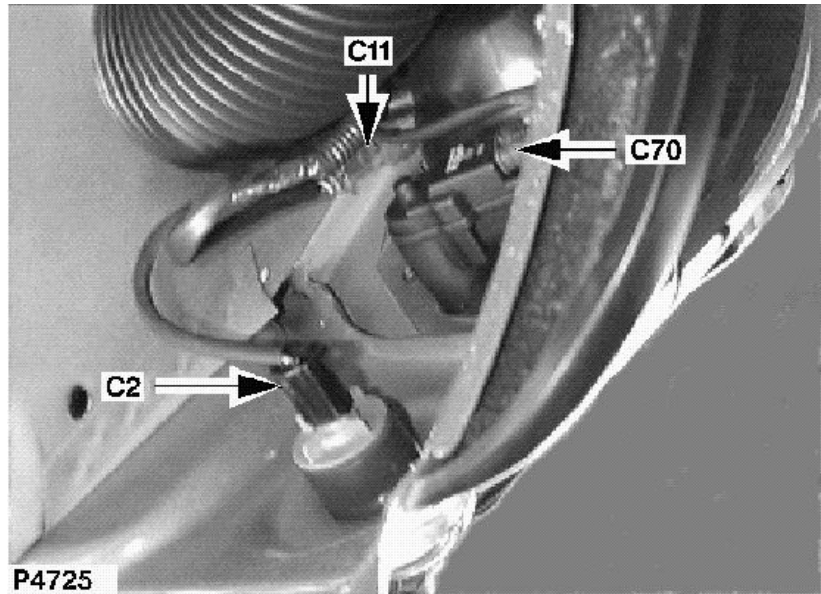

(NL)

Rechter voorste  
richtingaanwijzer - gloeilamp  
Vrouwelijk  
ZWART  
Achter rechter koplamp

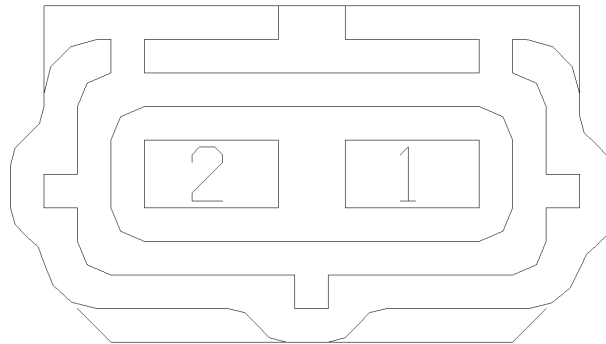

YPC10070

(E)

Luz intermitente de dirección  
delantera derecha  
Hembra  
NEGRO  
Detrás del faro derecho

Cav	Col	Cct
1	GW	ALL
2	B	ALL

**(GB)**

Horn(s)  
Female  
BLACK  
LH side of engine  
compartment

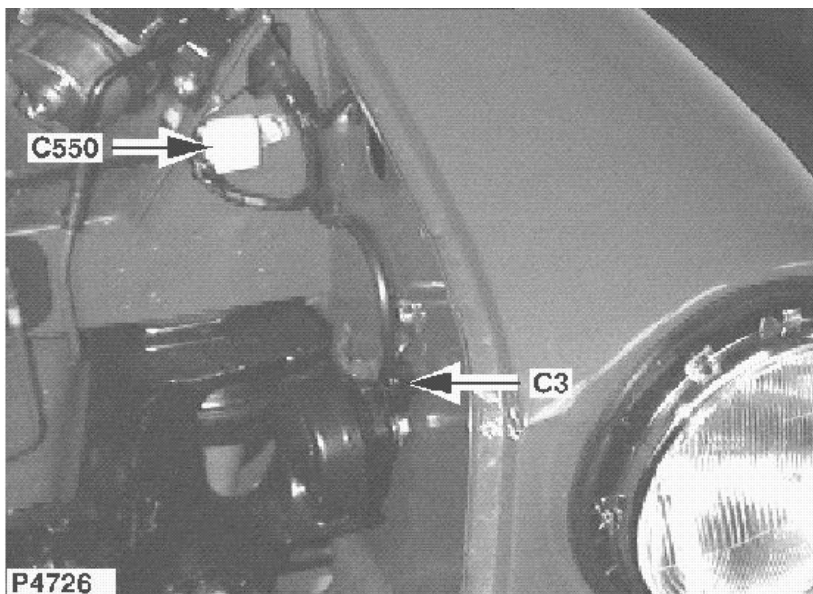
**(NL)**

Claxon(s)  
Vrouwelijk  
ZWART  
Linkerkant  
motorcompartiment

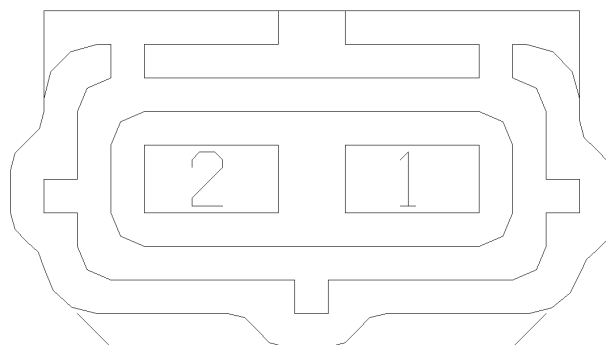

YPC10070

**(E)**

Bocina/s  
Hembra  
NEGRO  
Lado izquierdo del  
compartimento motor

Cav	Col	Cct
1	PB	ALL
2	B	ALL

# C5

## CONNECTOR / AANSLUITING / CONECTOR

**(GB)**

Cooling fan  
Female  
BLACK  
Lower front of engine - RH  
side

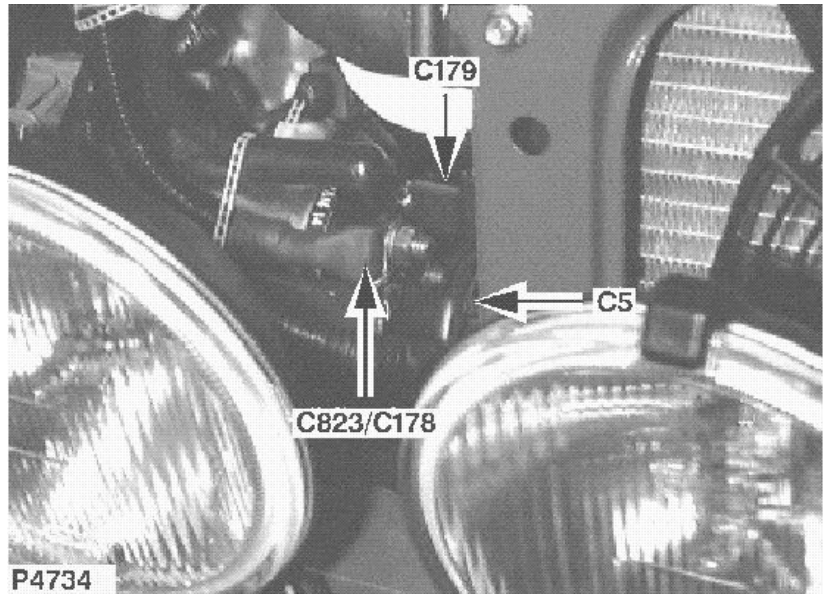

**(NL)**

Koelventilator  
Vrouwelijk  
ZWART  
Onder/voorkant motor -  
Rechts

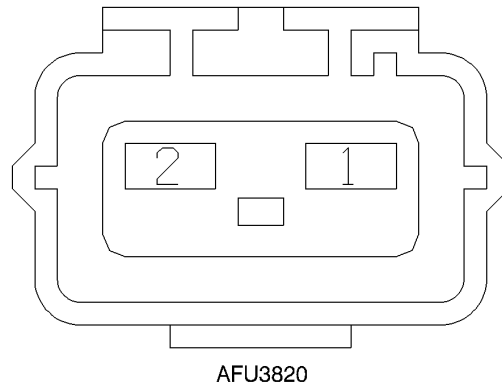

**(E)**

Ventilador de refrigeración  
Hembra  
NEGRO  
Parte delantera inferior del  
motor - Lado derecho

Cav	Col	Cct
1	BG	ALL
2	B	ALL

**(GB)**

Bonnet switch  
 Female  
 BLACK  
 Top of engine - RH side

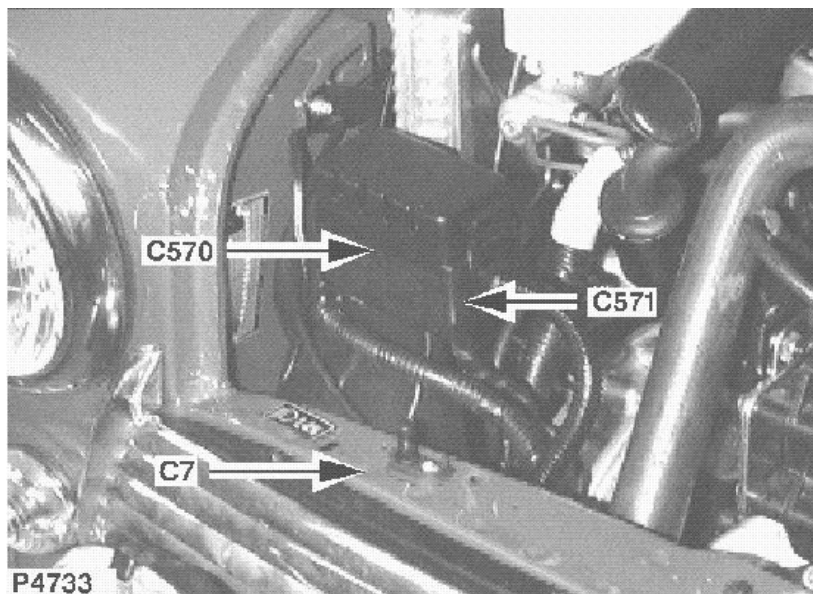
**(NL)**

Motorkap - schakelaar  
 Vrouwelijk  
 ZWART  
 bovenkant motor - Rechts

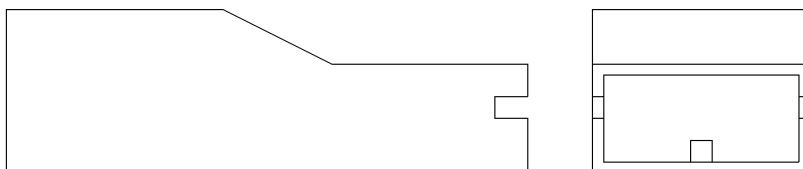

AAU1010

**(E)**

Interruptor del capó delantero  
 Hembra  
 NEGRO  
 parte superior del motor -  
 Lado derecho

Cav	Col	Cct
1	PR	ALL



**(GB)**

Windscreen washer pump  
Female  
BLACK  
Luggage compartment - RH  
side

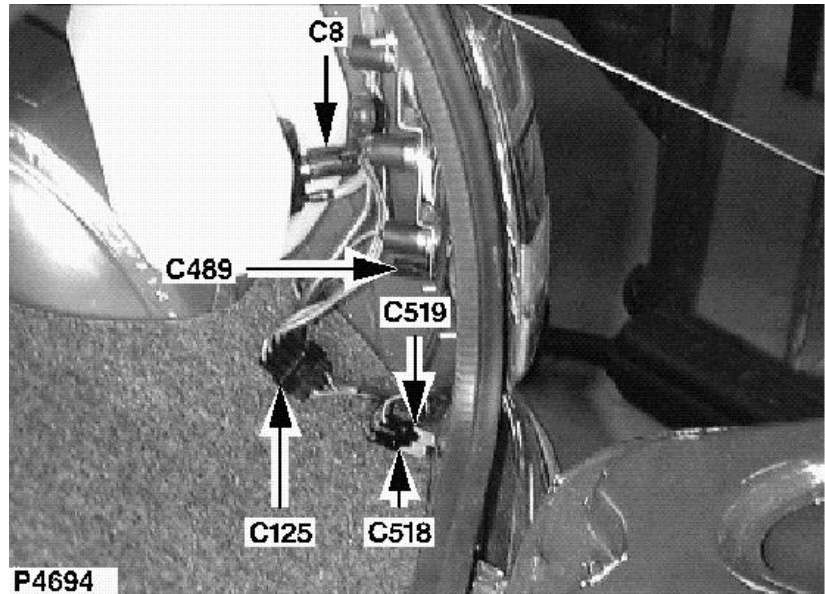

**(NL)**

Ruitesproeierpomp  
Vrouwelijk  
ZWART  
bagageruimte - Rechts

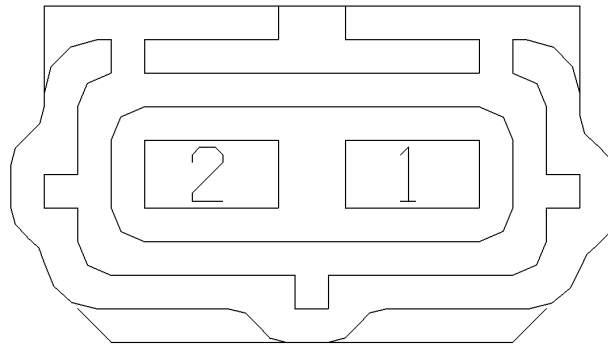

YPC10069

**(E)**

Bomba de lavaparabrisas  
Hembra  
NEGRO  
maletero - Lado derecho

Cav	Col	Cct
1	B	ALL
2	OR	ALL

**(GB)**

LH headlamp  
 Female  
 GREY  
 Behind LH headlamp

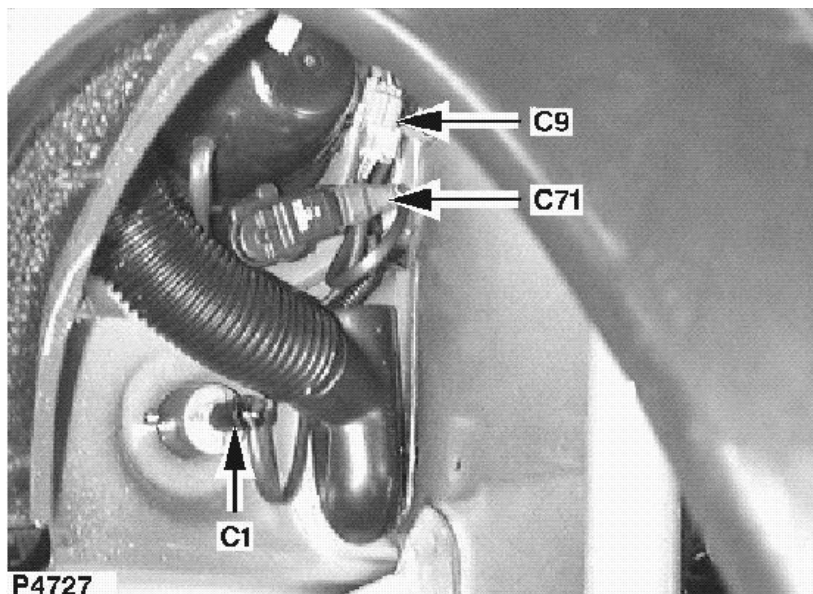

**(NL)**

Linker koplamp  
 Vrouwelijk  
 LEIGRIJS  
 Achter linker koplamp

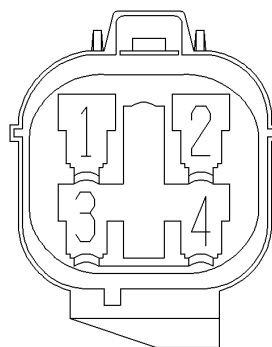

YPC10470

**(E)**

Faro izquierdo  
 Hembra  
 PIZARRO (GRIS)  
 Detrás del faro izquierdo

Cav	Col	Cct
1	B	ALL
2	RB	ALL
3	UR	ALL
4	UW	ALL

# C11

## CONNECTOR / AANSLUITING / CONECTOR

**(GB)**

RH headlamp  
Female  
GREY  
Behind RH headlamp

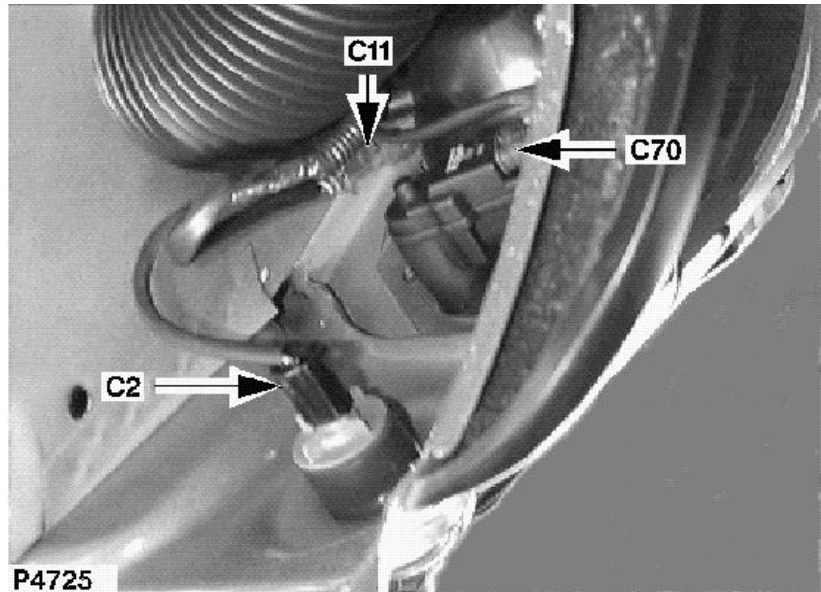

P4725

**(NL)**

Rechter koplamp  
Vrouwelijk  
LEIGRIJS  
Achter rechter koplamp

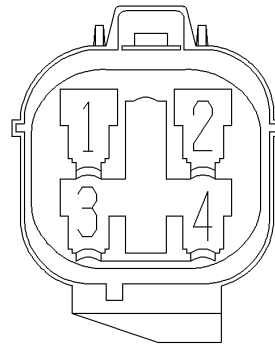

YPC10470

**(E)**

Faro derecho  
Hembra  
PIZARRO (GRIS)  
Detrás del faro derecho

Cav	Col	Cct
1	B	ALL
2	RW	ALL
3	UR	ALL
4	UW	ALL

**(GB)**

RH side repeater lamp  
 Female  
 BLACK  
 On the side of the front wing

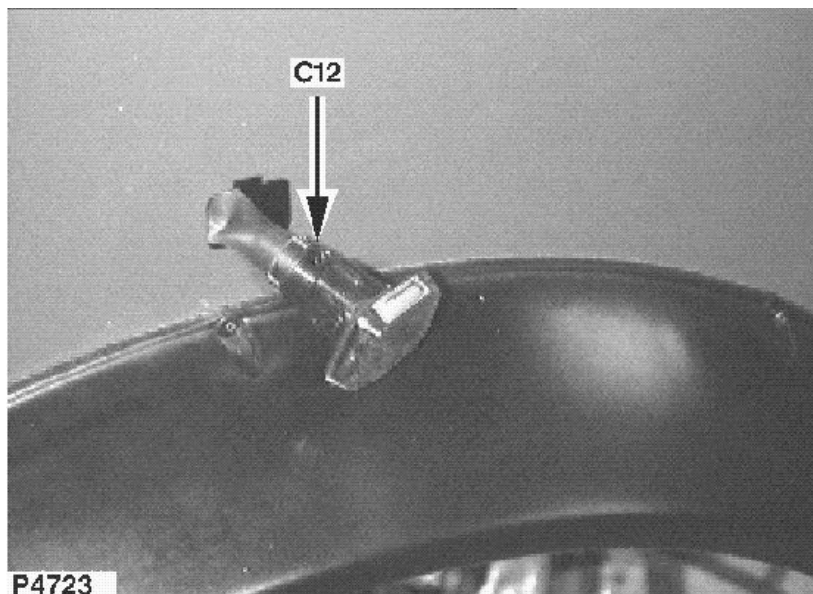
**(NL)**

Rechter zij-repeteerlamp -  
 gloeilamp  
 Vrouwelijk  
 ZWART  
 Op zijkant van voorspatbord

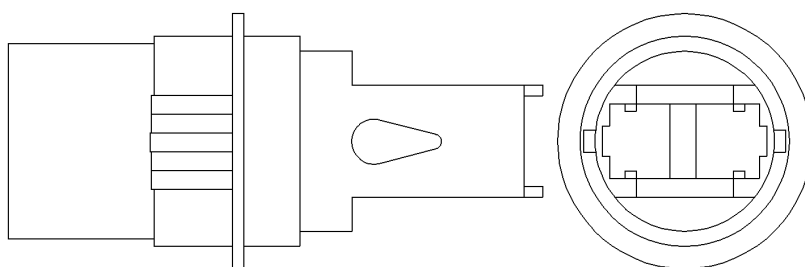

AFU3698

**(E)**

Luz repetidora derecha  
 Hembra  
 NEGRO  
 En el costado de la aleta  
 delantera

Cav	Col	Cct
1	GW	ALL
2	B	ALL

# C13

## CONNECTOR / AANSLUITING / CONECTOR

**(GB)**

LH side repeater lamp  
Female  
BLACK  
On the side of the front wing

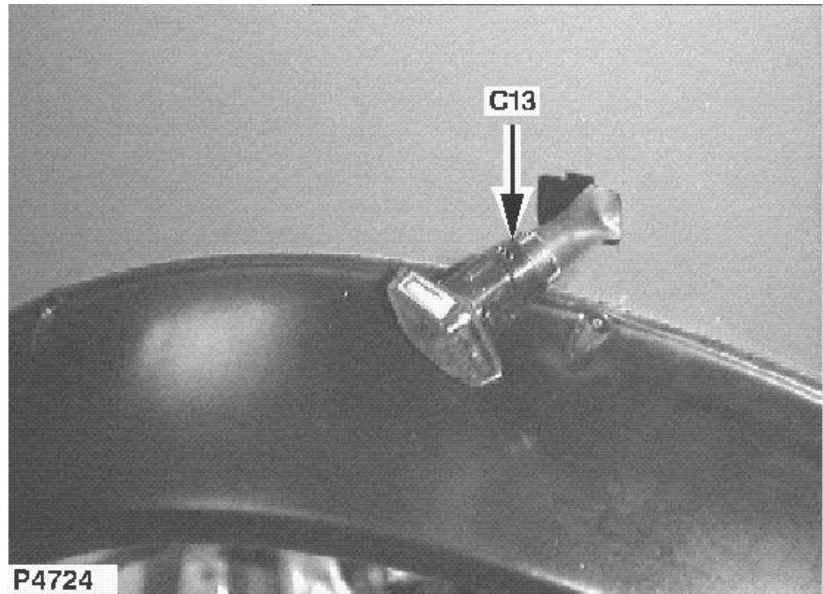

**(NL)**

Linker zij-repeteerlamp -  
gloeilamp  
Vrouwelijk  
ZWART  
Op zijkant van voorspatbord

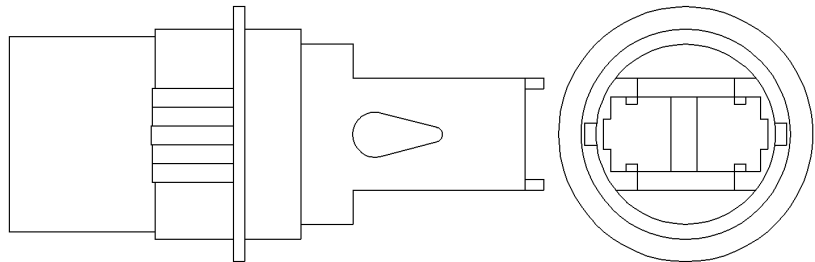

AFU3698

**(E)**

Luz repetidora izquierda  
Hembra  
NEGRO  
En el costado de la aleta  
delantera

Cav	Col	Cct
1	GR	ALL
2	B	ALL

**(GB)**

Cooling fan relay  
 Female  
 BLACK  
 LH side of bulkhead

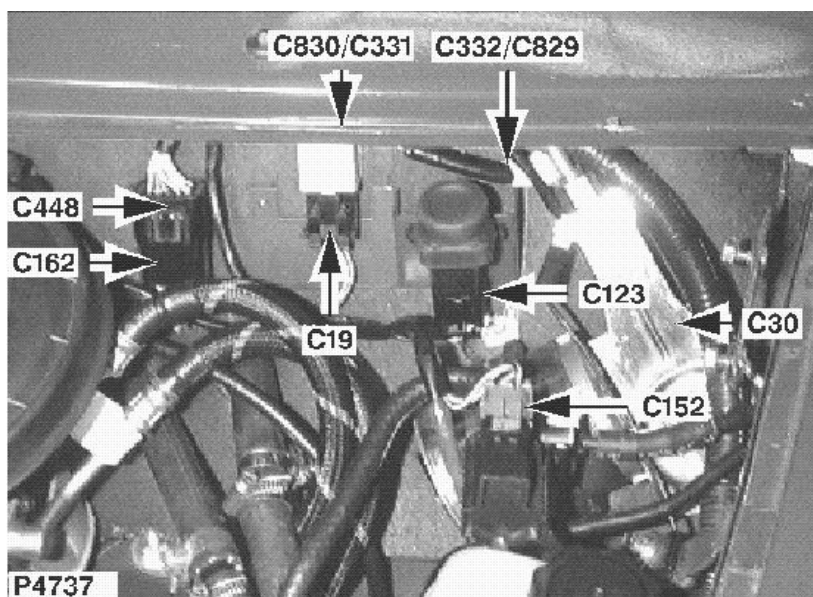

**(NL)**

Koelventilator - relais  
 Vrouwelijk  
 ZWART  
 Linkerkant tussenschot

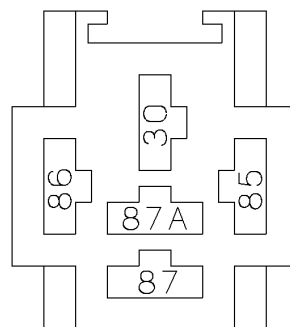

AGU1385

**(E)**

Relé del ventilador de refrigeración  
 Hembra  
 NEGRO  
 Lado izquierdo del salpicadero

Cav	Col	Cct
30	P	ALL
85	LGB	ALL
86	P	ALL
87	BG	ALL

**(GB)**

Body Harness to Number  
Plate Harness  
Female  
BLACK  
Luggage compartment lid

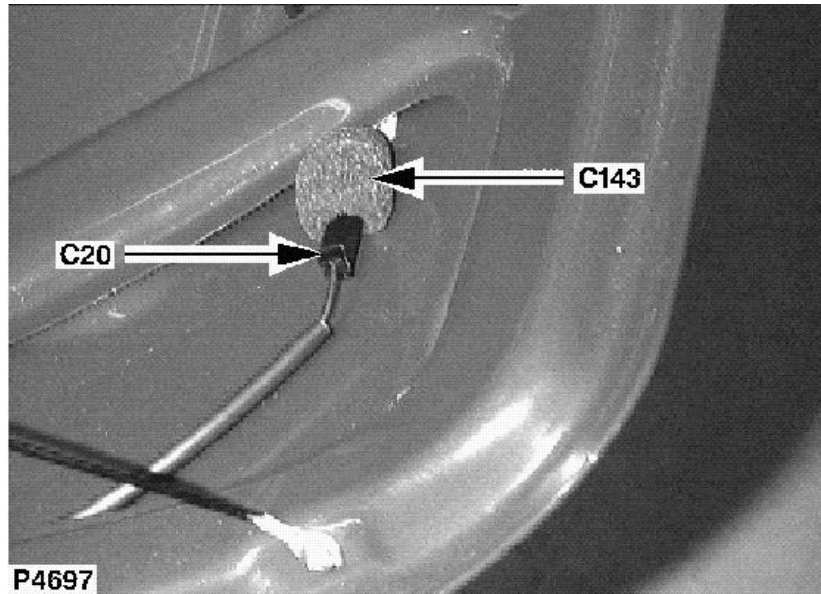

**(NL)**

Carrosserie-kabelbundel naar  
kabelbundel voor  
nummerplaat-verlichting  
Vrouwelijk  
ZWART  
Kofferdeksel

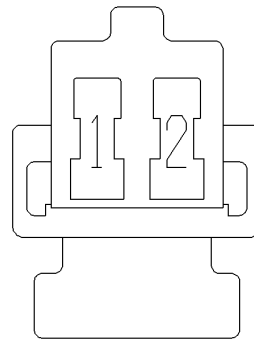

YPC10225

**(E)**

Mazo de cables de la  
carrocería al mazo de cables  
de matrícula  
Hembra  
NEGRO  
Capó trasero

Cav	Col	Cct
1	RB	ALL
2	B	ALL

**(GB)**

Front fog lamp relay  
 Female  
 BLACK  
 Rear RH side of engine compartment

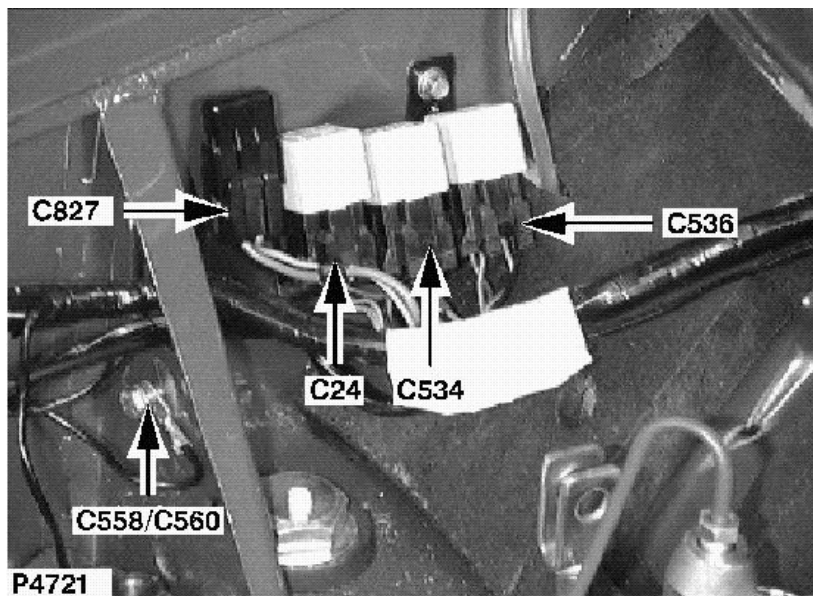

**(NL)**

Mistlamp voor - relais  
 Vrouwelijk  
 ZWART  
 Rechter achterkant motorcompartiment

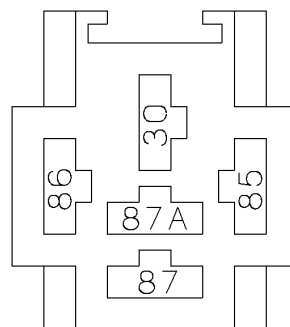

AGU1385

**(E)**

Relé de faros antiniebla delanteros  
 Hembra  
 NEGRO  
 Parte trasera derecha del compartimento motor

Cav	Col	Cct
30	PU	ALL
85	UG	ALL
86	B	ALL
87	UG	ALL



# C26

## CONNECTOR / AANSLUITING / CONECTOR

**(GB)**

Brake fluid level switch  
Female  
BLACK  
RH side of engine  
compartment

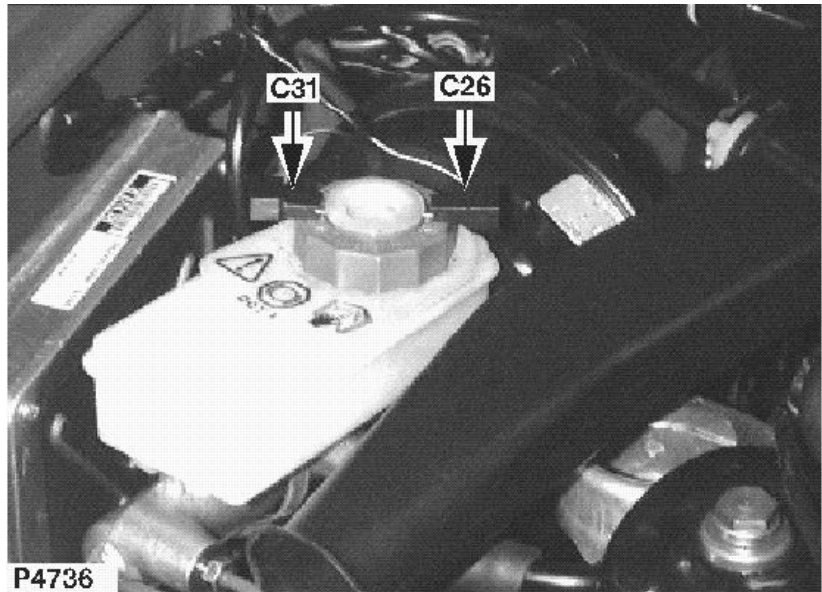

**(NL)**

Remvloeistofpeil - schakelaar  
Vrouwelijk  
ZWART  
Rechterkant  
motorcompartiment

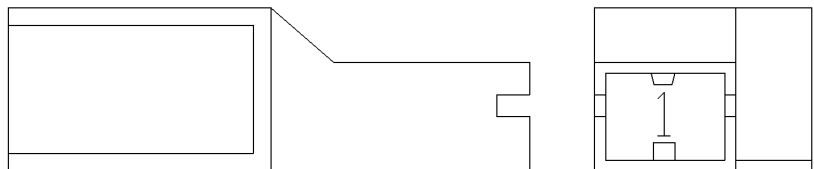

YPC10165

**(E)**

Interruptor del nivel de líquido  
de frenos  
Hembra  
NEGRO  
Lado derecho del  
compartimento motor

Cav	Col	Cct
1	BW	ALL

**(GB)**

Ignition  
 Female  
 NATURAL  
 Left of steering column

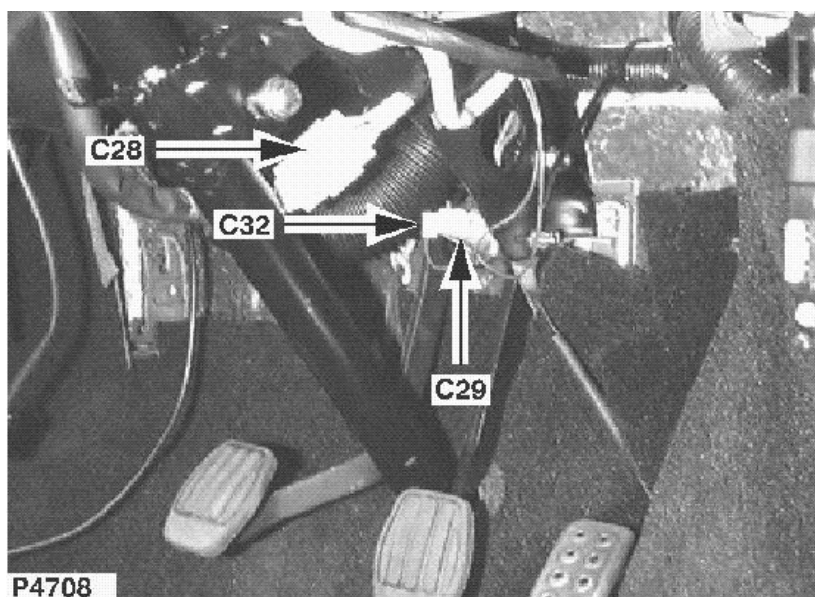
**(NL)**

Ontsteking  
 Vrouwelijk  
 NATUREL  
 links van stuurkolom

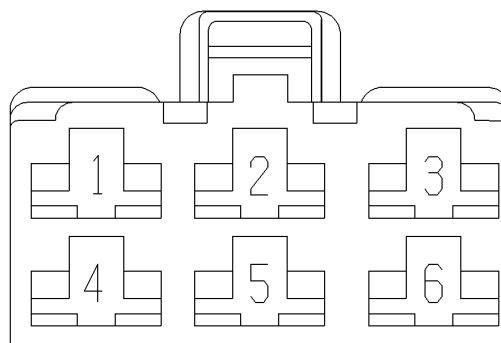

YPC10004

**(E)**

Encendido  
 Hembra  
 NATURAL  
 lado izquierdo de la columna  
 de dirección

Cav	Col	Cct
1	N	ALL
2	N	ALL
3	LG	ALL
4	Y	ALL
5	WR	ALL
6	W	ALL

(GB)

Brake pedal switch  
Female  
NATURAL  
Left of steering column

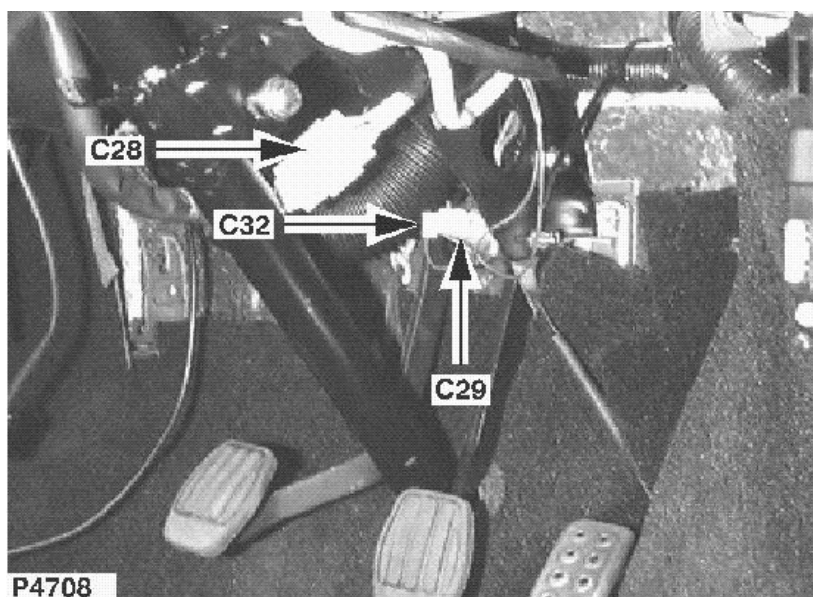

(NL)

Rempedaal - schakelaar  
Vrouwelijk  
NATUREL  
links van stuurkolom

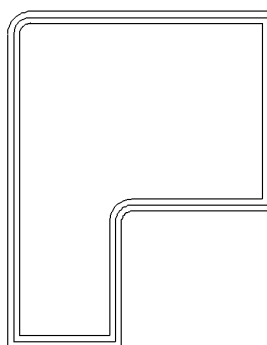

YPM10002

(E)

Interruptor del pedal de freno  
Hembra  
NATURAL  
lado izquierdo de la columna  
de dirección

Cav	Col	Cct
1	G	ALL

**(GB)**

Windscreen wiper motor  
 Female  
 GREY  
 LH side of bulkhead

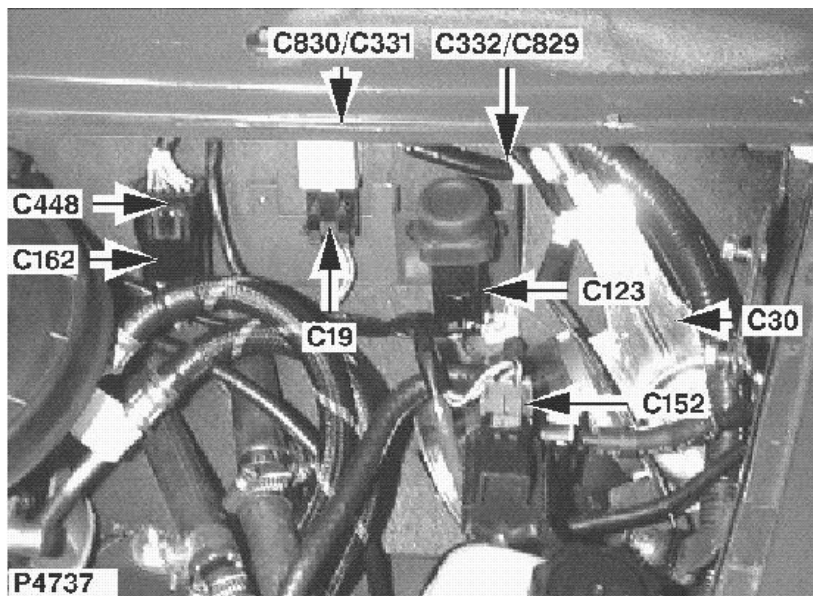

**(NL)**

Ruitewissermotor  
 Vrouwelijk  
 LEIGRIJS  
 Linkerkant tussenschot

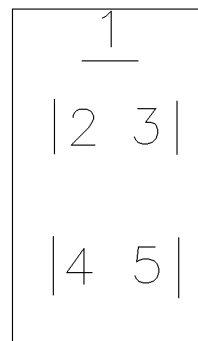

BMK1409

**(E)**

Motor de limpiaparabrisas  
 Hembra  
 PIZARRO (GRIS)  
 Lado izquierdo del salpicadero

Cav	Col	Cct
1	B	ALL
2	NLG	ALL
3	ULG	ALL
4	LGO	ALL
5	RLG	ALL

# C31

## CONNECTOR / AANSLUITING / CONECTOR

**(GB)**

Brake fluid level switch  
Female  
BLACK  
RH side of engine  
compartment

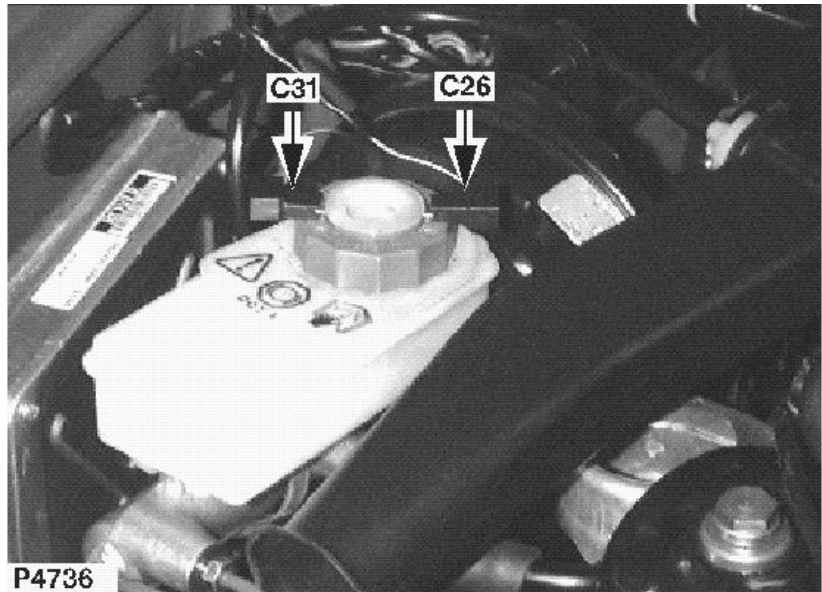

**(NL)**

Remvloeistofpeil - schakelaar  
Vrouwelijk  
ZWART  
Rechterkant  
motorcompartiment

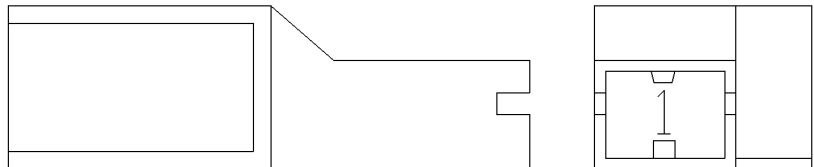

YPC10165

**(E)**

Interruptor del nivel de líquido  
de frenos  
Hembra  
NEGRO  
Lado derecho del  
compartimento motor

Cav	Col	Cct
1	B	ALL

**(GB)**

Brake pedal switch  
 Female  
 NATURAL  
 Left of steering column

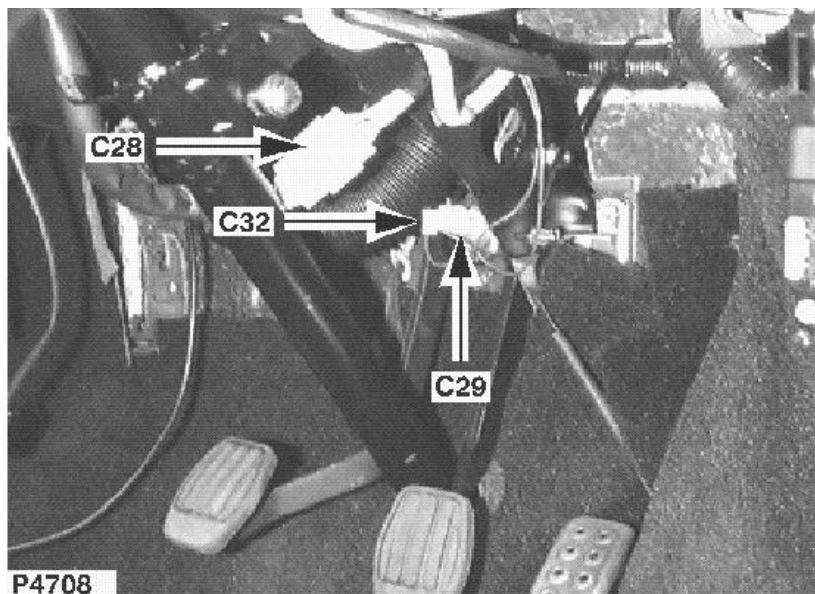
**(NL)**

Rempedaal - schakelaar  
 Vrouwelijk  
 NATUREL  
 links van stuurkolom

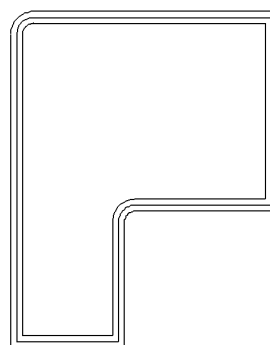

YPM10002

**(E)**

Interruptor del pedal de freno  
 Hembra  
 NATURAL  
 lado izquierdo de la columna  
 de dirección

Cav	Col	Cct
1	GP	ALL

**(GB)**

Front wiper switch  
 Female  
 NATURAL  
 Behind steering column cowl -  
 RH side

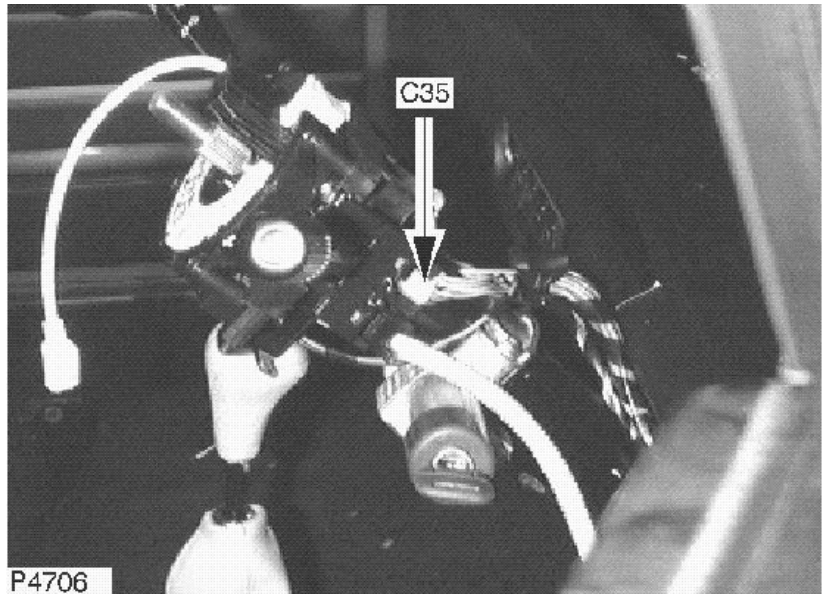

**(NL)**

Voortuitwischer - schakelaar  
 Vrouwelijk  
 NATUREL  
 Achter stuurkolomkap - rechts

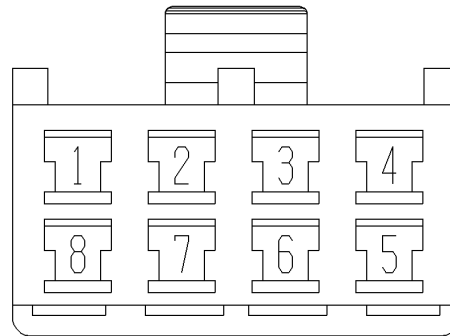

YPC10006

**(E)**

Interruptor de  
 limpiaparabrisas  
 Hembra  
 NATURAL  
 Debajo de la carcasa de la  
 columna de dirección - Lado  
 derecho

Cav	Col	Cct
1	LGO	ALL
2	LGG	ALL
3	ULG	ALL
4	RLG	ALL
5	LGO	ALL
7	NLG	ALL
8	OR	ALL

**(GB)**

Direction indicator switch  
 Female  
 NATURAL  
 Behind steering column cowl  
 LH side

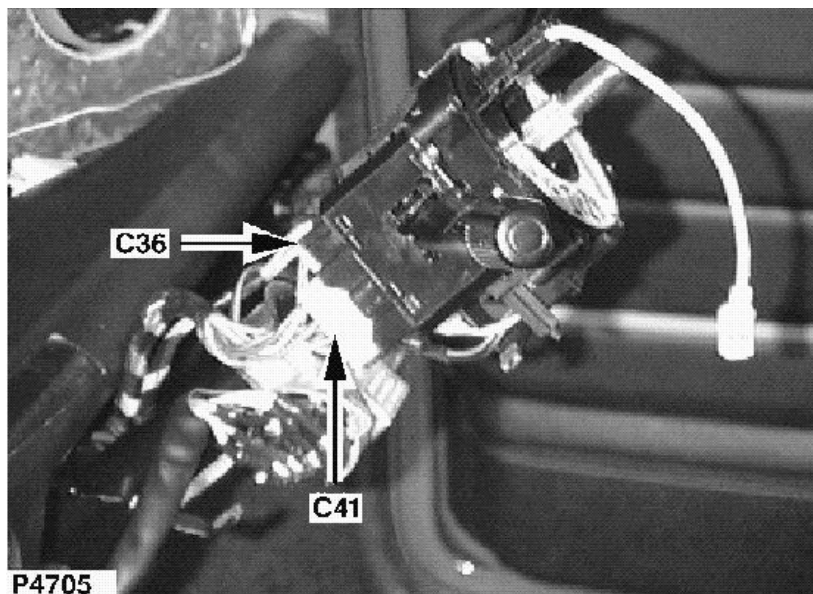
**(NL)**

Richtingaanwijzers -  
 staafschakelaar  
 Vrouwelijk  
 NATUREL  
 Achter stuurkolomkap - links

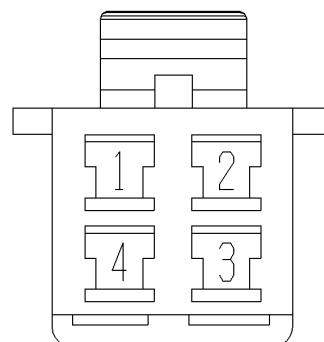

YPC10002

**(E)**

Interruptor de intermitentes de  
 dirección  
 Hembra  
 NATURAL  
 Detrás del costado izquierdo  
 de la carcasa de la columna  
 de dirección

Cav	Col	Cct
1	GR	ALL
2	LGN	ALL
4	GW	ALL



# C40

## CONNECTOR / AANSLUITING / CONECTOR

(GB)

Diagnostic socket  
Female  
GREY  
Under RH side of fascia

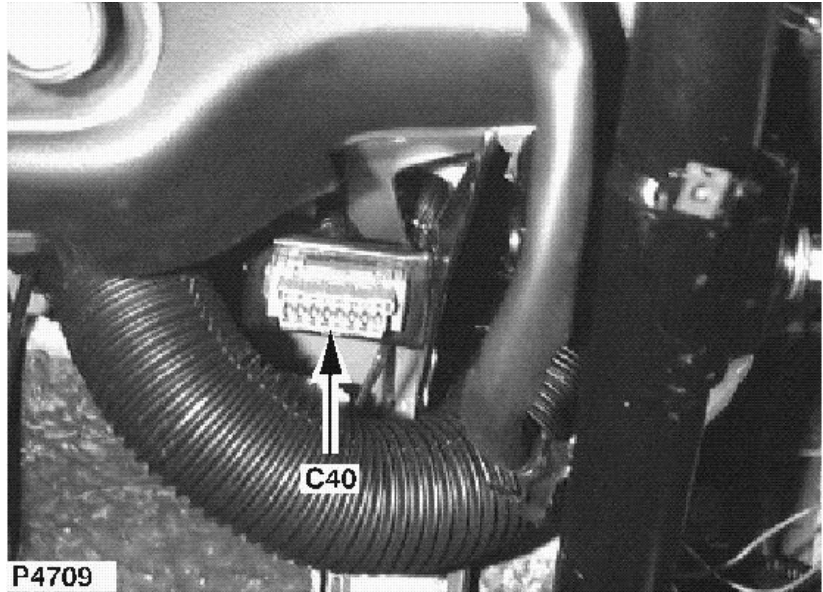

(NL)

Diagnose-aansluiting  
Vrouwelijk  
LEIGRIJS  
Onder rechterkant dashboard

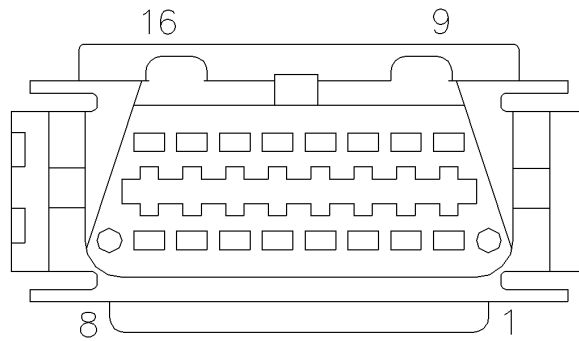

YPC107910

(E)

Enchufe de diagnóstico  
Hembra  
PIZARRO (GRIS)  
Debajo del lado derecho del  
tablero

Cav	Col	Cct
1	PS	ALL
3	RG	ALL
4	B	ALL
7	WY	ALL
13	YK	ALL
16	P	ALL

**(GB)**

Lighting switch  
 Female  
 NATURAL  
 Behind steering column cowl  
 LH side

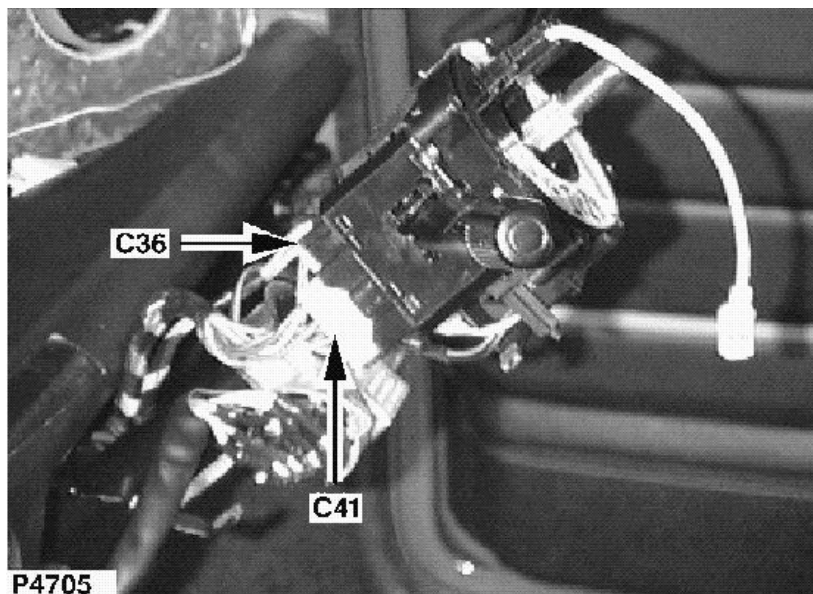
**(NL)**

Verlichtingsschakelaar  
 Vrouwelijk  
 NATUREL  
 Achter stuurkolomkap - links

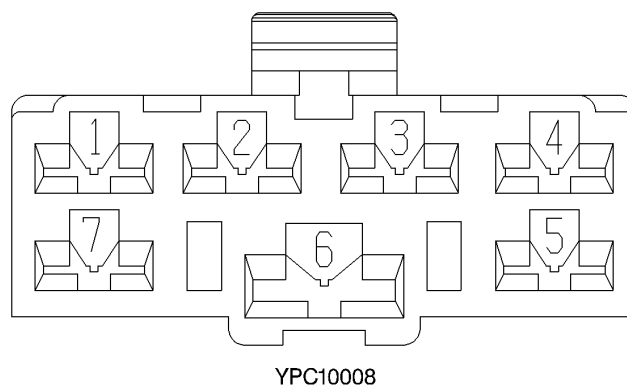
**(E)**

Interruptor de alumbrado  
 Hembra  
 NATURAL  
 Detrás del costado izquierdo  
 de la carcasa de la columna  
 de dirección

Cav	Col	Cct
1	U	ALL
2	UR	ALL
3	N	ALL
4	R	ALL
5	UW	ALL
6	N	ALL

# C56

## CONNECTOR / AANSLUITING / CONECTOR

**(GB)**

Blower fan  
Female  
RED  
Behind centre of fascia

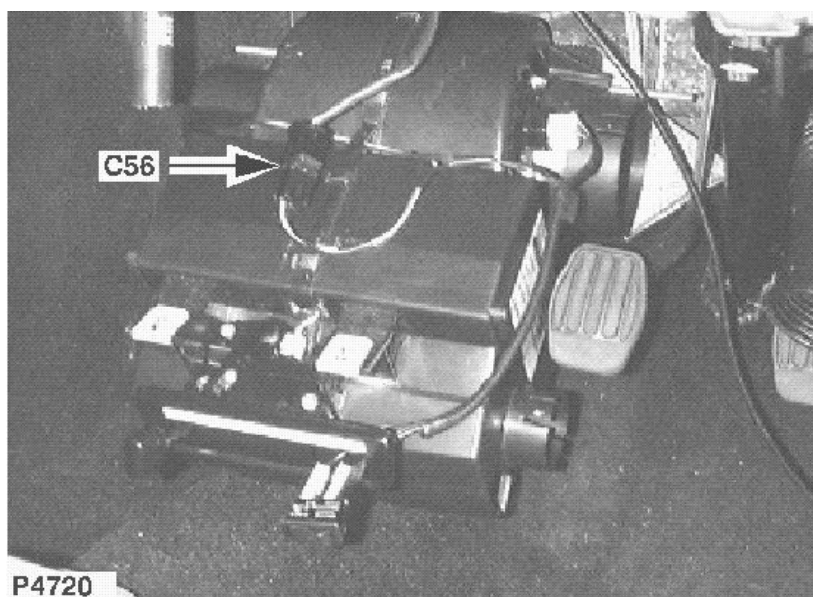

**(NL)**

Ventilator  
Vrouwelijk  
ROOD  
achter middelste gedeelte  
dashboard

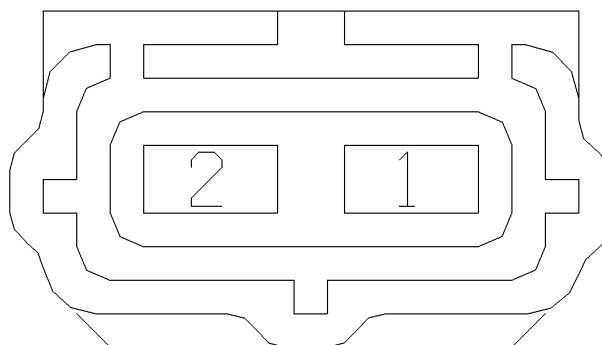

YPC10131

**(E)**

Ventilador de soplante  
Hembra  
ROJO  
detrás de la parte central del  
tablero

Cav	Col	Cct
1	LGO	ALL
2	B	ALL

**(GB)**

Alarm ECU  
 Female  
 GREY  
 Behind centre of fascia

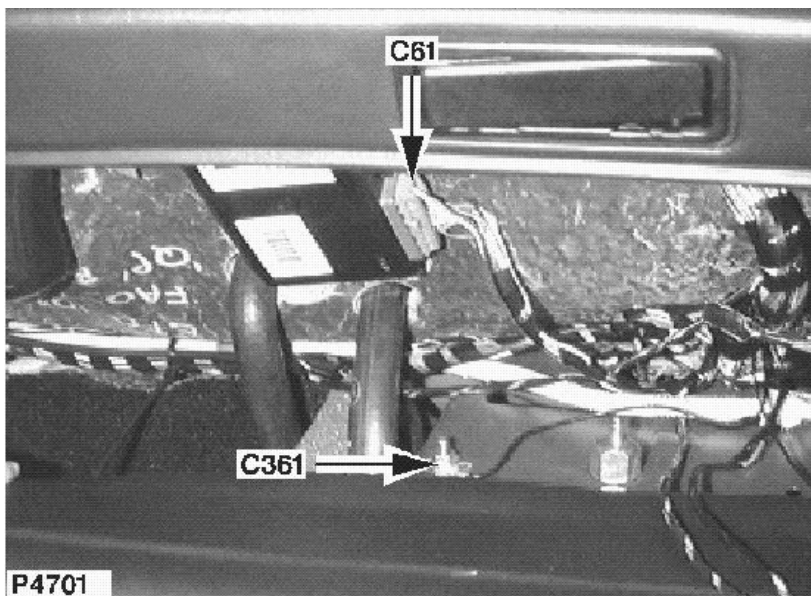

**(NL)**

Alarm - ECU  
 Vrouwelijk  
 LEIGRIJS  
 achter middelste gedeelte  
 dashboard

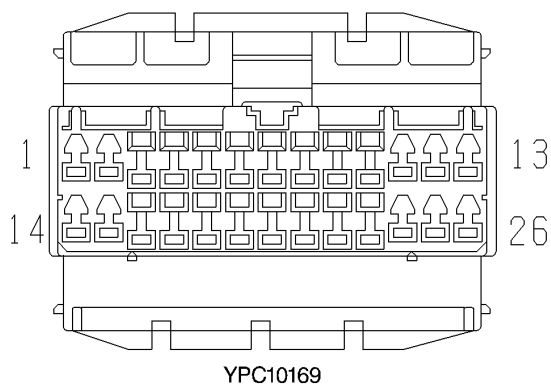

**(E)**

UEC de alarma  
 Hembra  
 PIZARRO (GRIS)  
 detrás de la parte central del  
 tablero

Cav	Col	Cct	Cav	Col	Cct
1	W	ALL	17	YN	ALL
2	B	ALL	18	PR	ALL
7	PW	ALL	19	B	ALL
8	PB	ALL	21	PK	ALL
9	WS	ALL	23	WR	ALL
10	WY	ALL	24	PS	ALL
16	RG	ALL	26	P	ALL

# C64

## CONNECTOR / AANSLUITING / CONECTOR

**(GB)**

Rear fog lamp switch  
Female  
NATURAL  
Behind centre of fascia

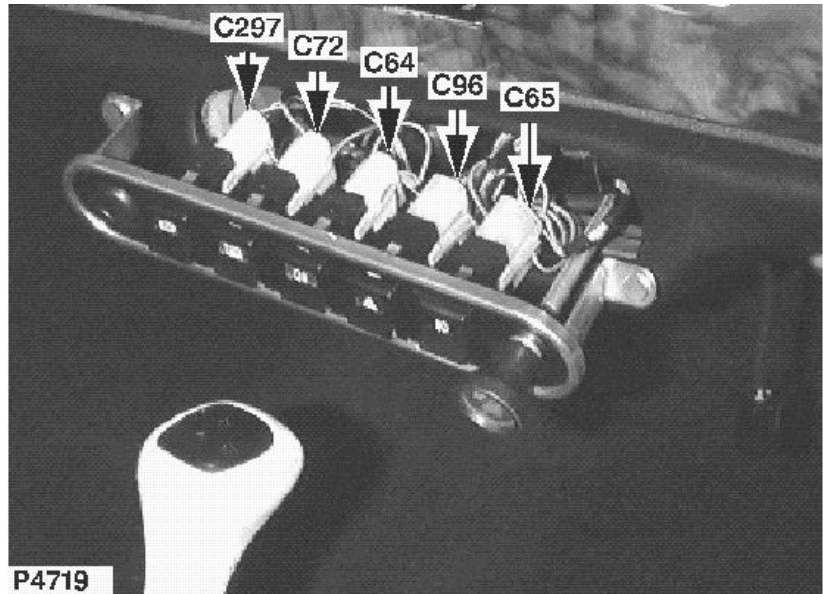

**(NL)**

Mistachterlamp - schakelaar  
Vrouwelijk  
NATUREL  
achter middelste gedeelte  
dashboard

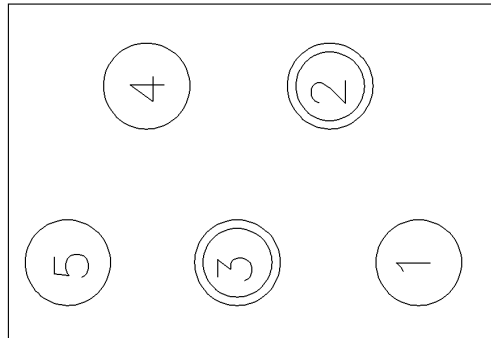

13H9745

**(E)**

Interruptor de pilotos  
antiniebla traseros  
Hembra  
NATURAL  
detrás de la parte central del  
tablero

Cav	Col	Cct
2	UO	ALL
3	UY	ALL

**(GB)**

Front fog lamp switch  
 Female  
 NATURAL  
 Behind centre of fascia

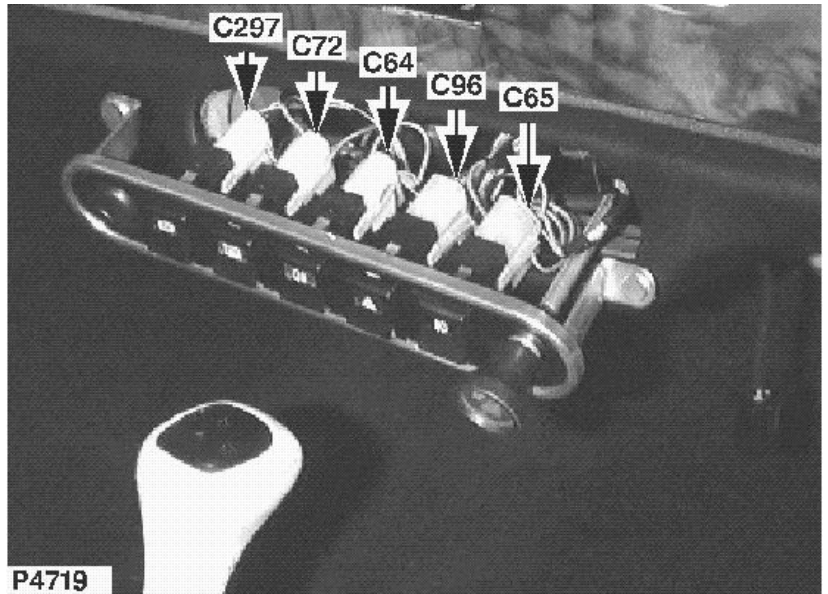

P4719

**(NL)**

Mistlamp voor - schakelaar  
 Vrouwelijk  
 NATUREL  
 achter middelste gedeelte  
 dashboard

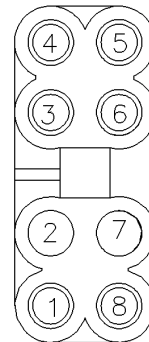

13H9746

**(E)**

Interruptor de faros antiniebla  
 delanteros  
 Hembra  
 NATURAL  
 detrás de la parte central del  
 tablero

Cav	Col	Cct
1	UG	ALL
4	UW	ALL
5	UB	ALL
8	RB	ALL

# C70

## CONNECTOR / AANSLUITING / CONECTOR

(GB)

RH headlamp levelling motor  
Female  
NATURAL  
Behind RH headlamp

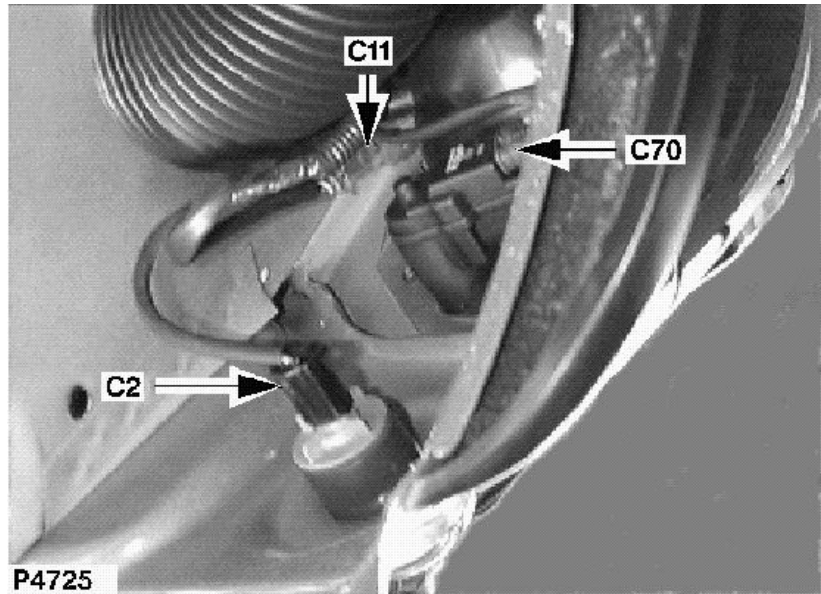

(NL)

Rechter koplamp-nivellering -  
motor  
Vrouwelijk  
NATUREL  
Achter rechter koplamp

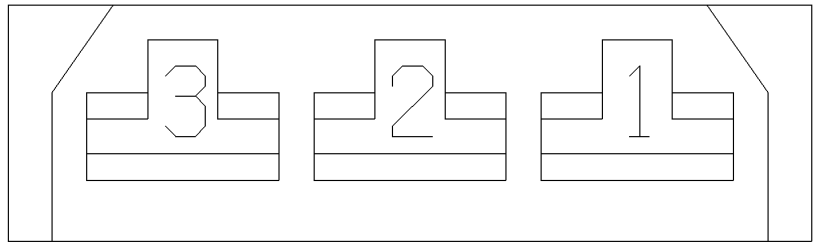

YPC10426

(E)

Motor de nivelación del faro  
derecho  
Hembra  
NATURAL  
Detrás del faro derecho

Cav	Col	Cct
1	UG	ALL
2	B	ALL
3	R	ALL

**(GB)**

LH headlamp levelling motor  
 Female  
 NATURAL  
 Behind LH headlamp

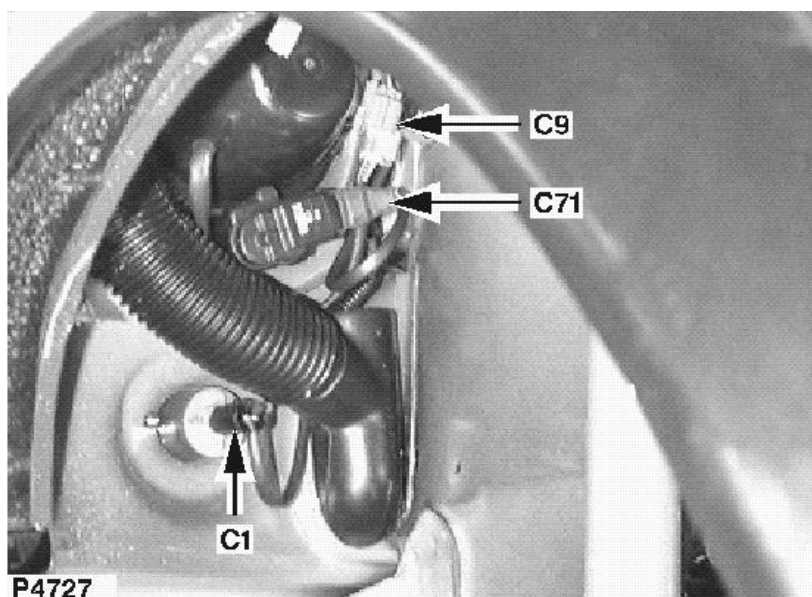
**(NL)**

Linker koplamp-nivellering -  
 motor  
 Vrouwelijk  
 NATUREL  
 Achter linker koplamp

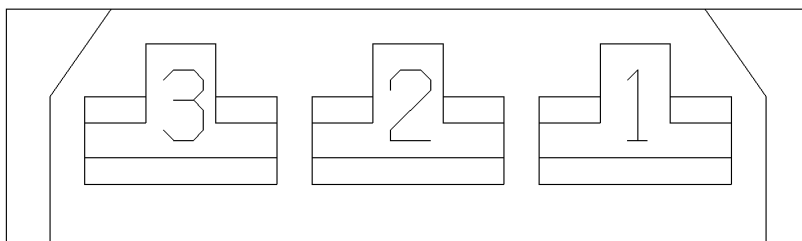

YPC10426

**(E)**

Motor de nivelación del faro  
 izquierdo  
 Hembra  
 NATURAL  
 Detrás del faro izquierdo

Cav	Col	Cct
1	UG	ALL
2	B	ALL
3	R	ALL



# C72

## CONNECTOR / AANSLUITING / CONECTOR

**(GB)**

Heated rear window switch  
Female  
NATURAL  
Behind centre of fascia

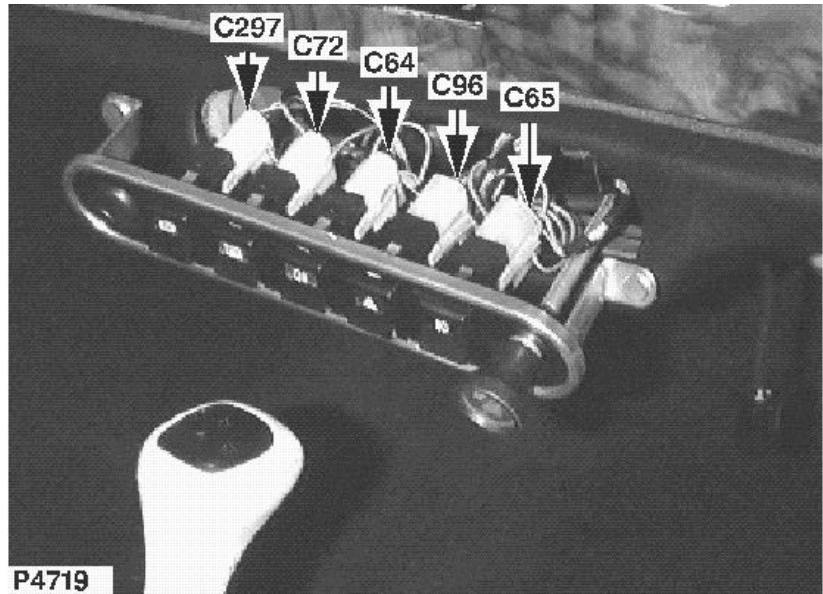

**(NL)**

Verwarmde achterrait -  
schakelaar  
Vrouwelijk  
NATUREL  
achter middelste gedeelte  
dashboard

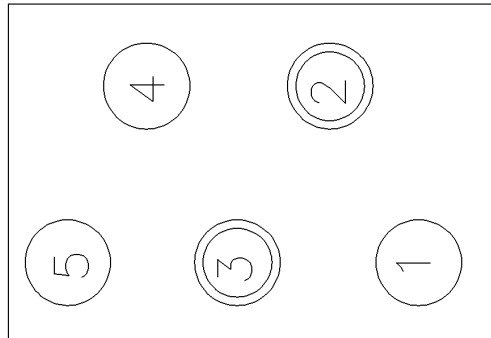

13H9745

**(E)**

Interruptor de luneta térmica  
Hembra  
NATURAL  
detrás de la parte central del  
tablero

Cav	Col	Cct
2	GY	ALL
3	G	ALL

**(GB)**

Rotary coupler  
 Female  
 WHITE  
 Underside of steering column

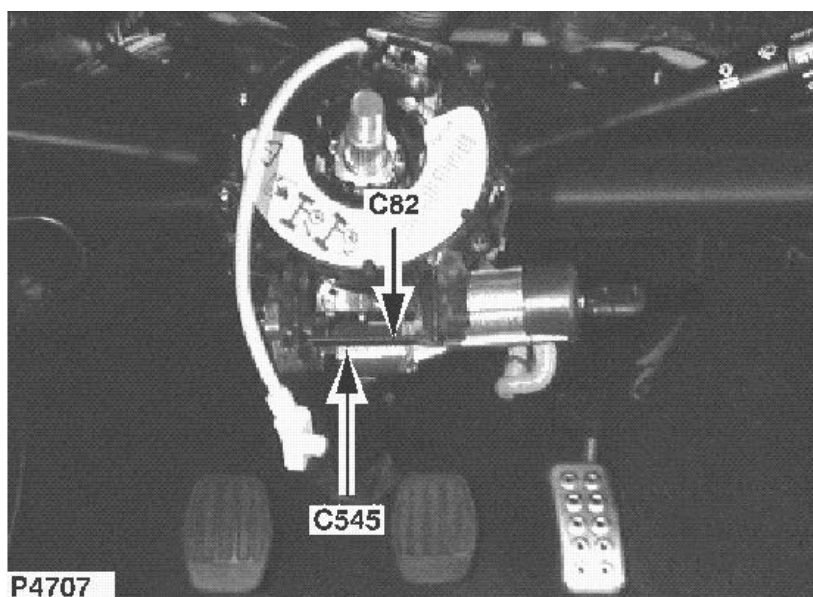
**(NL)**

ROTERENDE KOPPELING  
 Vrouwelijk  
 WIT  
 onderkant van stuurkolom

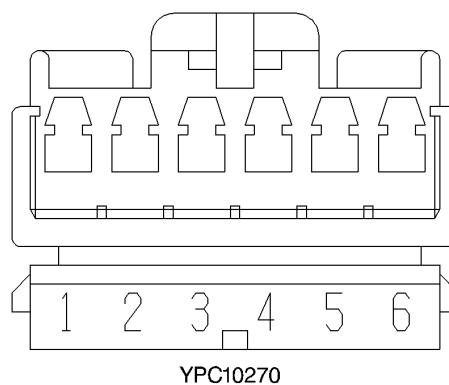
**(E)**

ACOPLADOR GIRATORIO  
 Hembra  
 BLANCO  
 parte inferior de la columna  
 de dirección

Cav	Col	Cct
4	PB	ALL
6	B	ALL

# C92

## CONNECTOR / AANSLUITING / CONECTOR

**(GB)**

Radio speakers  
Female  
BROWN  
Behind radio

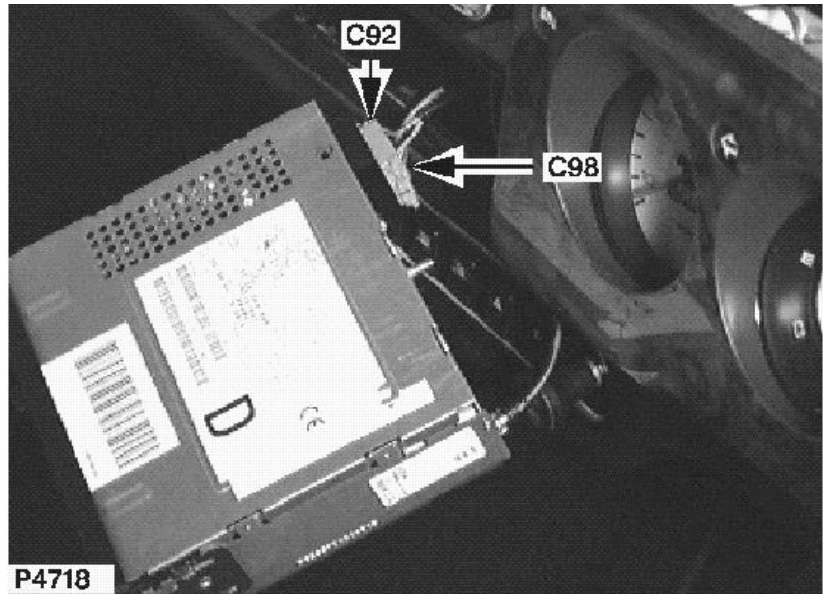

**(NL)**

Radio - luidsprekers  
Vrouwelijk  
BRUIN  
Achter radio

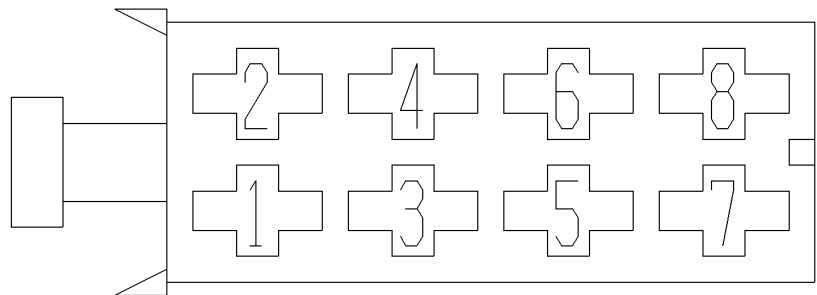

YPC10191

**(E)**

Altavoces de radio  
Hembra  
MARRON  
Detrás de la radio

Cav	Col	Cct
1	SK	ALL
2	SB	ALL
7	UK	ALL
8	UB	ALL

**(GB)**

Headlamp levelling switch  
Female  
BLACK  
Behind RH side of fascia

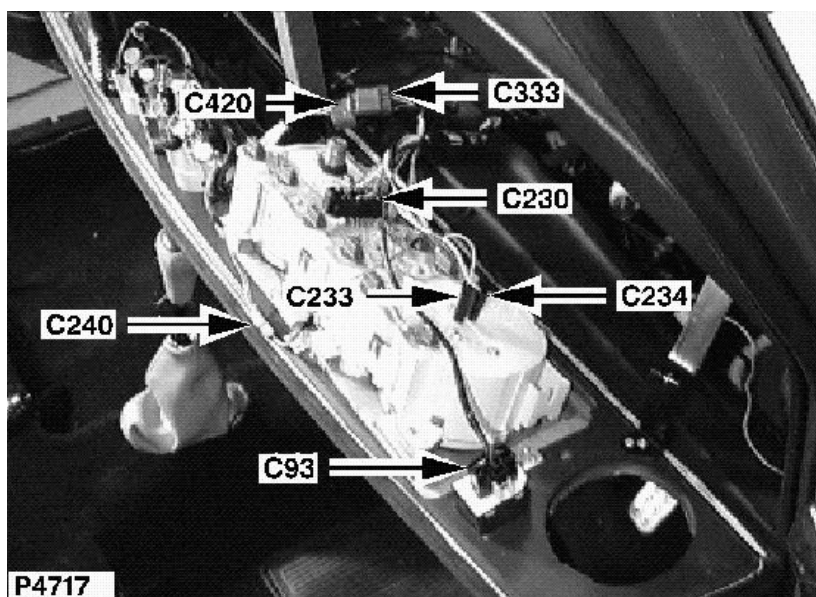
**(NL)**

Koplamp-nivellering -  
schakelaar  
Vrouwelijk  
ZWART  
Achter rechterkant dashboard

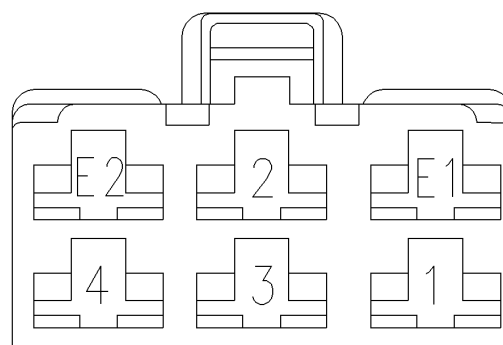

YPC10521

**(E)**

Mando de nivelación de faros  
Hembra  
NEGRO  
Detrás del lado derecho del  
tablero

Cav	Col	Cct
1	R	ALL
2	UG	ALL
4	R	ALL
E2	B	ALL

**(GB)**

Clock  
Female  
BLACK  
Behind centre of fascia

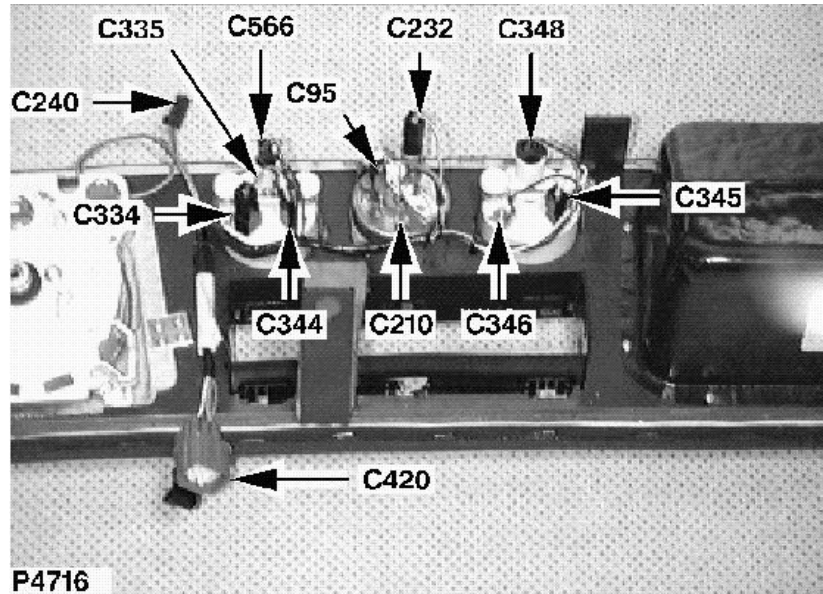

**(NL)**

Klok  
Vrouwelijk  
ZWART  
achter middelste gedeelte  
dashboard

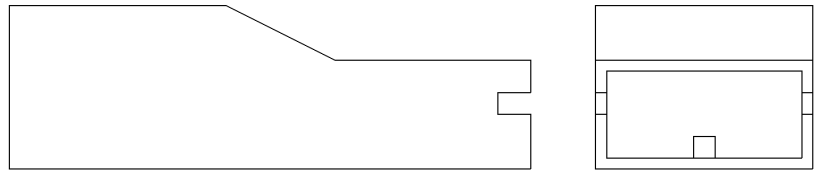

AAU1010

**(E)**

Reloj  
Hembra  
NEGRO  
detrás de la parte central del  
tablero

Cav	Col	Cct
1	PO	All

**(GB)**

Hazard warning switch  
Female  
NATURAL  
Behind centre of fascia

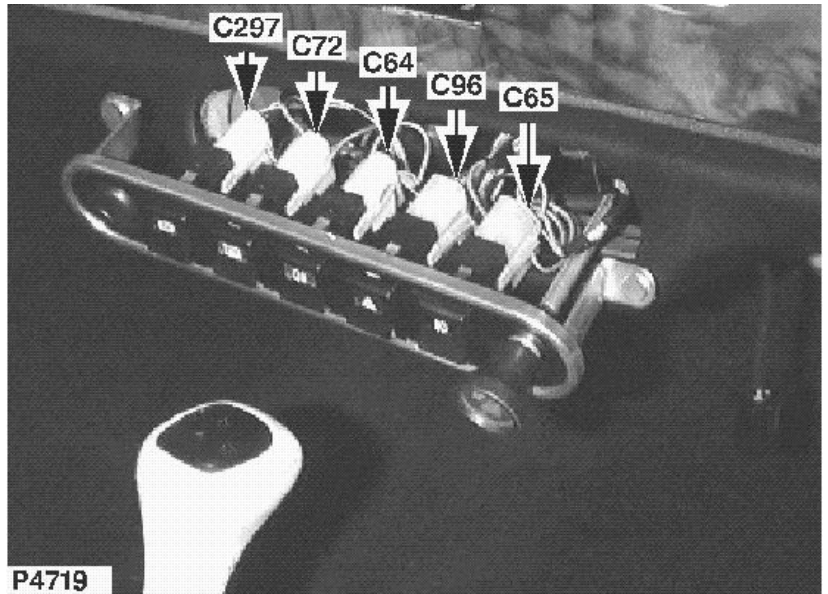

**(NL)**

Alarmknipperlichten -  
schakelaar  
Vrouwelijk  
NATUREL  
achter middelste gedeelte  
dashboard

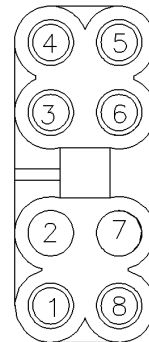

13H9746

**(E)**

Interruptor de luces  
intermitentes de emergencia  
Hembra  
NATURAL  
detrás de la parte central del  
tablero

Cav	Col	Cct
3	LGK	ALL
4	GR	ALL
5	GW	ALL
6	GLG	ALL

**(GB)**

Rear fog lamp  
Male  
BLACK  
Luggage compartment - LH  
side

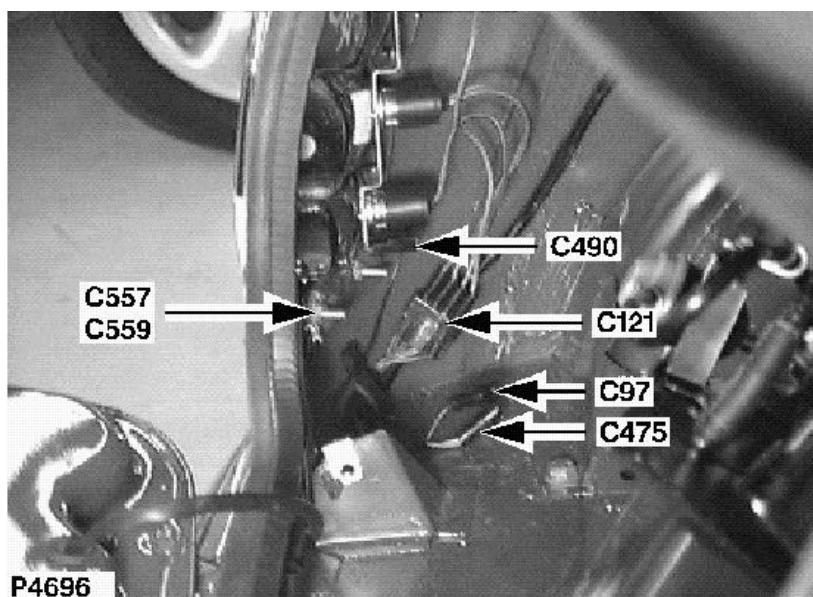

**(NL)**

Mistachterlamp  
Mannelijk  
ZWART  
bagageruimte - Links

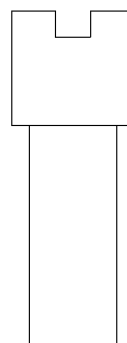

ADU2150

**(E)**

Piloto antiniebla trasero  
Macho  
NEGRO  
maletero - Lado izquierdo

Cav	Col	Cct
1	B	ALL

**(GB)**

Radio/cassette player  
 Female  
 GREY  
 Behind radio

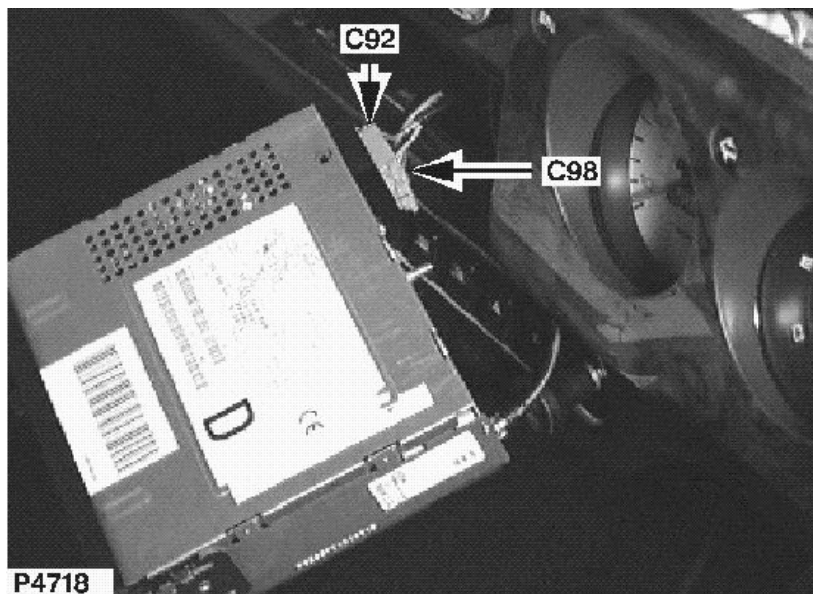

**(NL)**

Radio/cassette-speler  
 Vrouwelijk  
 LEIGRIJS  
 Achter radio

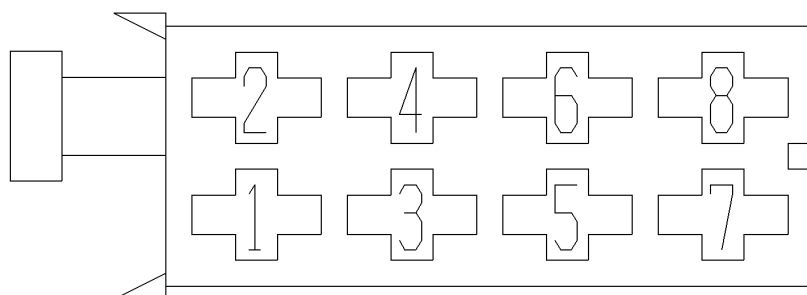

YPC10190

**(E)**

Radio/cassette  
 Hembra  
 PIZARRO (GRIS)  
 Detrás de la radio

Cav	Col	Cct
4	PO	ALL
7	LGW	ALL
8	B	ALL



# C101

## CONNECTOR / AANSLUITING / CONECTOR

**(GB)**

Body Harness to Main  
Harness  
Male  
BLACK  
LH 'A' post

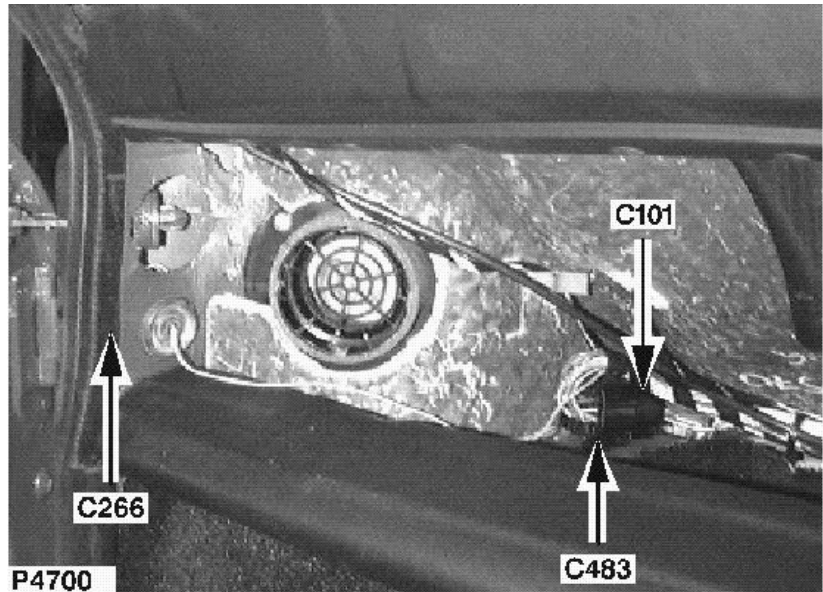

**(NL)**

Carrosserie-kabelbundel naar  
hoofdkabelbundel  
Mannelijk  
ZWART  
Linker 'A' stijl

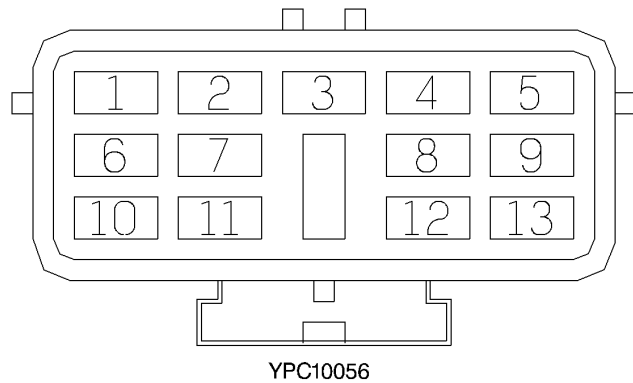

**(E)**

Mazo de cables de la  
carrocería al mazo de cables  
principal  
Macho  
NEGRO  
Pilar A izquierdo

Cav	Col	Cct	Cav	Col	Cct
1	GP	ALL	7	GB	ALL
2	UY	ALL	9	PK	ALL
3	GN	ALL	10	WP	ALL
4	GW	ALL	11	OR	ALL
5	GR	ALL	12	RW	ALL
6	RB	ALL	13	GY	ALL

**(GB)**

Fuel pump  
 Female  
 NATURAL  
 Luggage compartment - LH  
 side

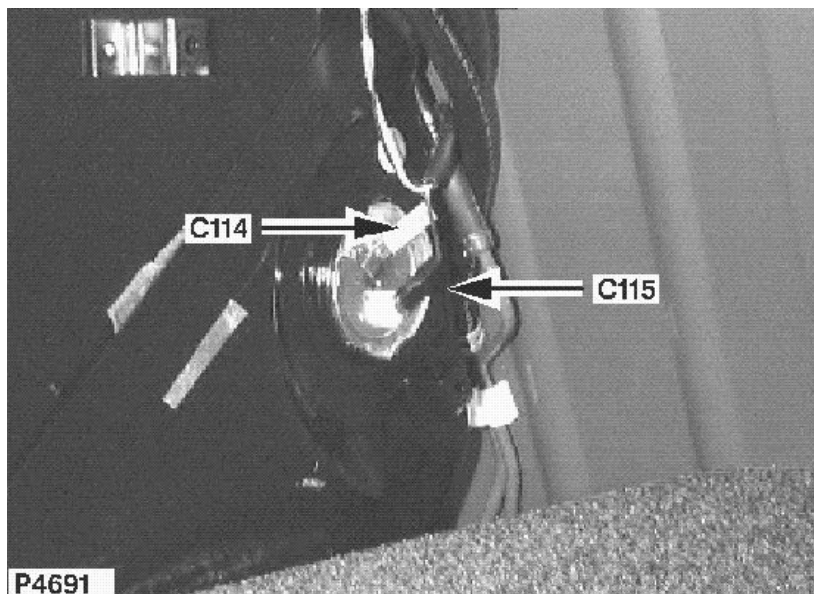
**(NL)**

Brandstofpomp  
 Vrouwelijk  
 NATUREL  
 bagageruimte - Links

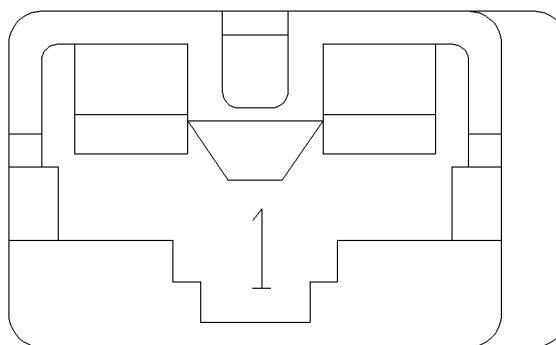

AFU4521

**(E)**

Bomba de combustible  
 Hembra  
 NATURAL  
 maletero - Lado izquierdo

Cav	Col	Cct
1	B	ALL

# C115

## CONNECTOR / AANSLUITING / CONECTOR

**(GB)**

Fuel sender unit  
Female  
BLACK  
Luggage compartment - LH  
side

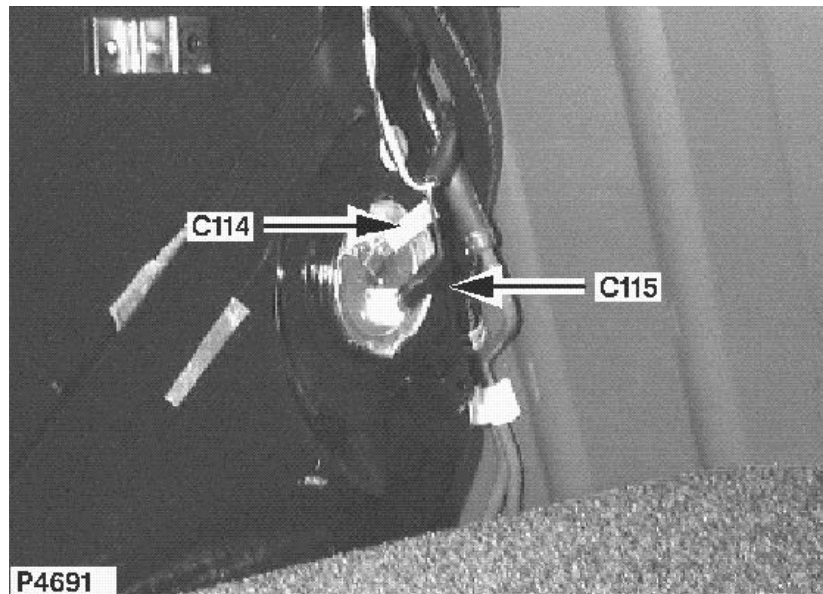

**(NL)**

Brandstof - zendelement  
Vrouwelijk  
ZWART  
bagageruimte - Links

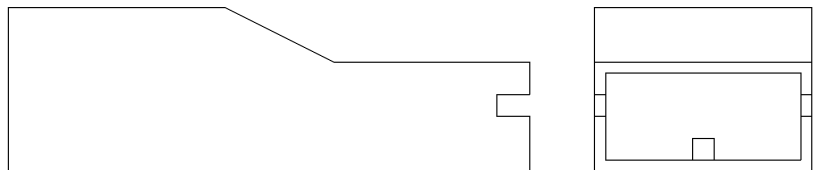

AAU1010

**(E)**

Sensor de nivel de  
combustible  
Hembra  
NEGRO  
maletero - Lado izquierdo

Cav	Col	Cct
1	GB	ALL

**(GB)**

LH tail lamp  
 Female  
 BLACK  
 Luggage compartment - LH  
 side

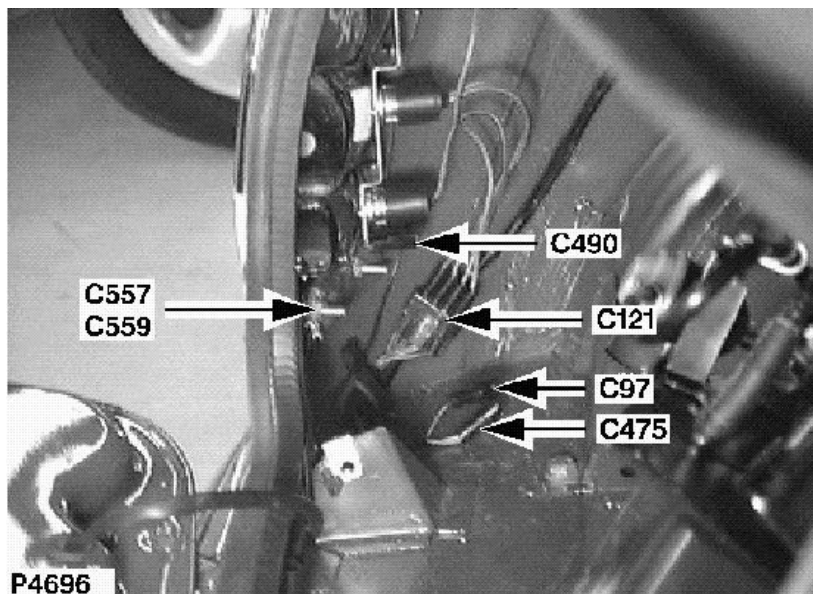
**(NL)**

Linker achterlicht  
 Vrouwelijk  
 ZWART  
 bagageruimte - Links

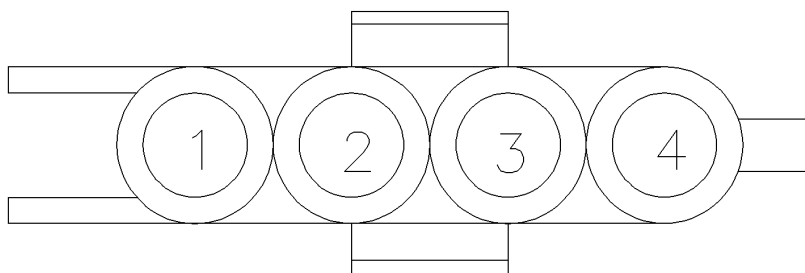

ADU2160

**(E)**

Piloto trasero izquierdo  
 Hembra  
 NEGRO  
 maletero - Lado izquierdo

Cav	Col	Cct
1	GN	ALL
2	RB	ALL
3	GP	ALL
4	GR	ALL

# C123

## CONNECTOR / AANSLUITING / CONECTOR

(GB)

Inertia switch  
Female  
BLACK  
LH side of bulkhead

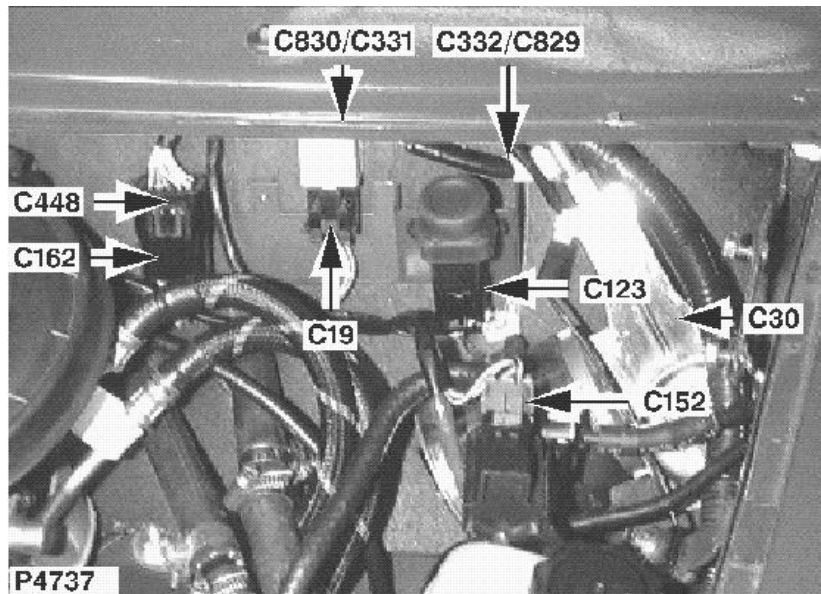

(NL)

Inertieschakelaar  
Vrouwelijk  
ZWART  
Linkerkant tussenschot

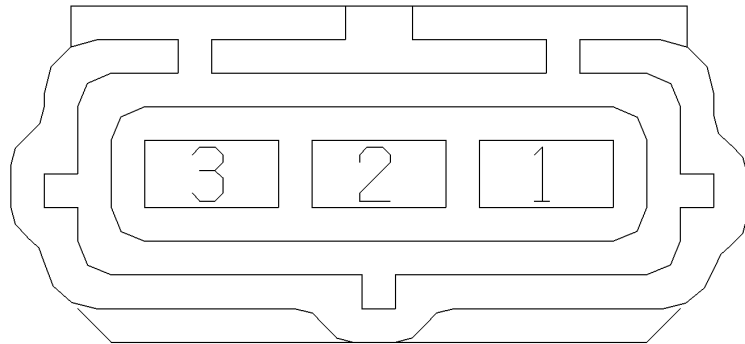

YPC10068

(E)

Interruptor inercial  
Hembra  
NEGRO  
Lado izquierdo del  
salpicadero

Cav	Col	Cct
1	NS	ALL
3	WP	ALL

**(GB)**

RH tail lamp  
 Female  
 BLACK  
 Luggage compartment - RH  
 side

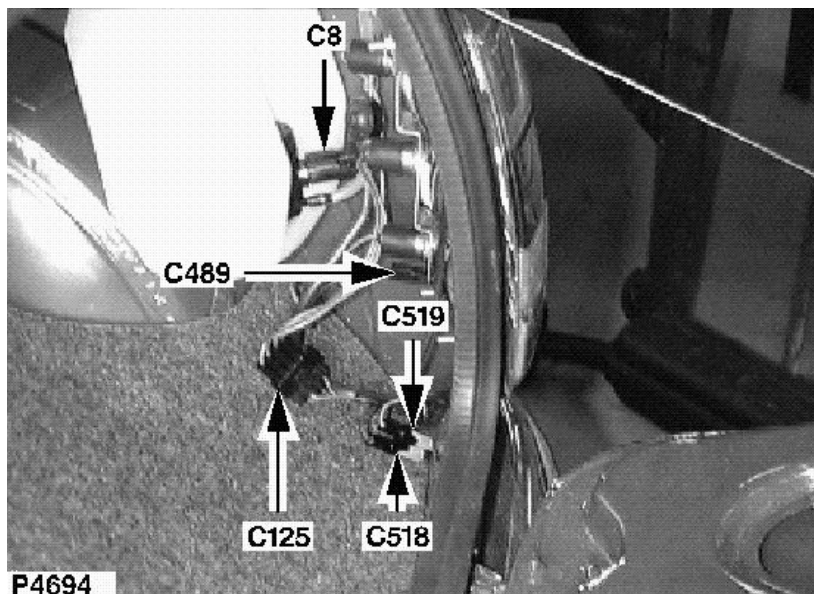
**(NL)**

Rechter achterlicht  
 Vrouwelijk  
 ZWART  
 bagageruimte - Rechts

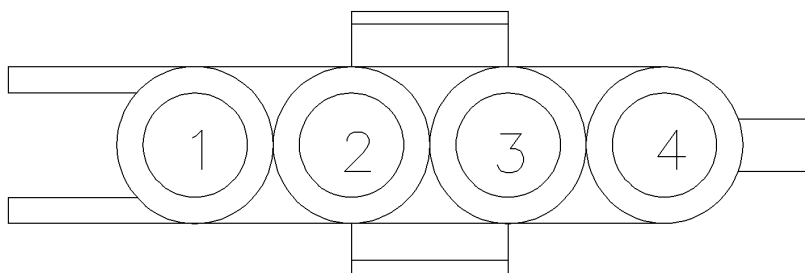

ADU2160

**(E)**

Piloto trasero derecho  
 Hembra  
 NEGRO  
 maletero - Lado derecho

Cav	Col	Cct
1	GN	ALL
2	RW	ALL
3	GP	ALL
4	GW	ALL

**(GB)**

Horn relay  
Female  
YELLOW  
Behind centre of fascia

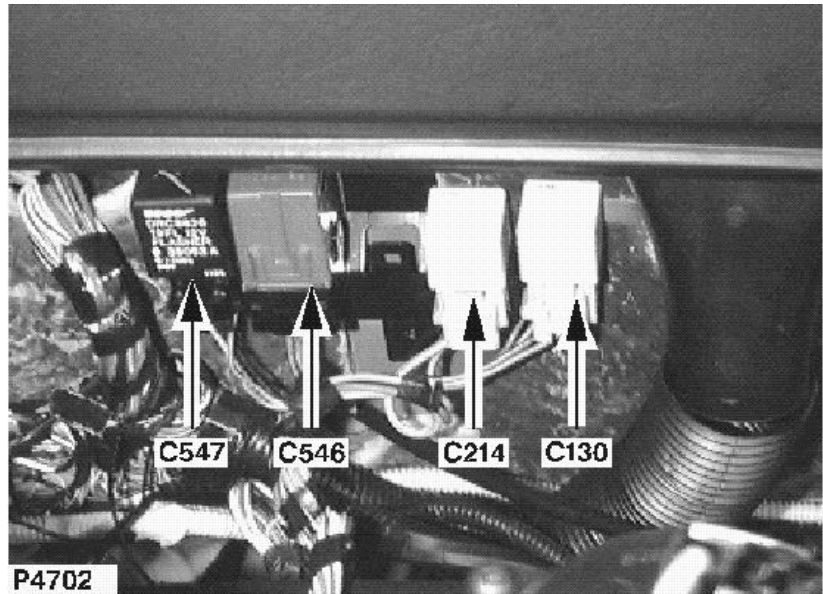

**(NL)**

Claxon - relais  
Vrouwelijk  
GEEL  
achter middelste gedeelte  
dashboard

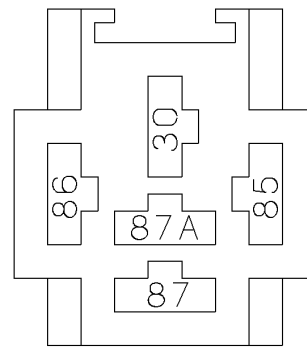

AFU3271

**(E)**

Relé de bocina  
Hembra  
AMARILLO  
detrás de la parte central del  
tablero

Cav	Col	Cct
30	P	ALL
85	P	ALL
86	PB	ALL
87	PB	ALL

**(GB)**

Number plate illumination  
lamp(s)  
Female  
BRASS  
Boot lid - inside

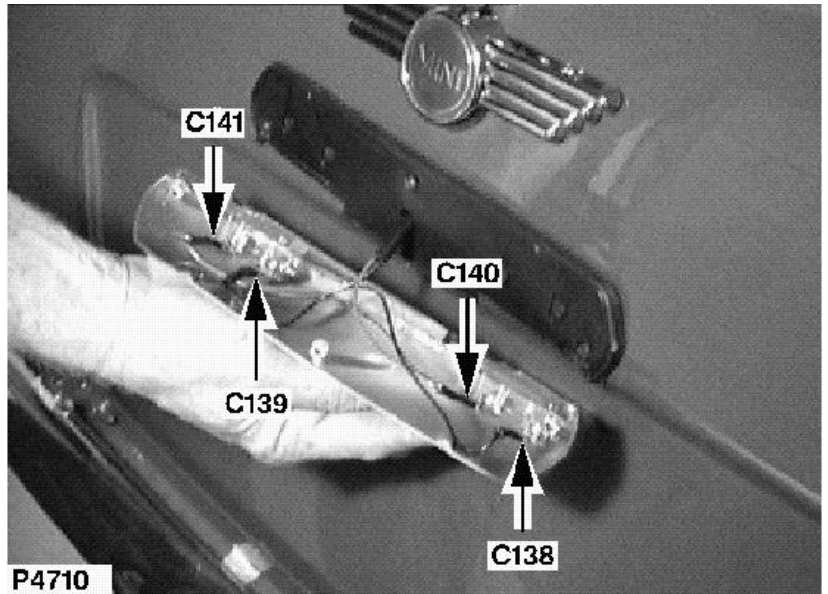

**(NL)**

Nummerplaatverlichting -  
lamp(en)  
Vrouwelijk  
KOPER  
Kofferdeksel - binnenkant

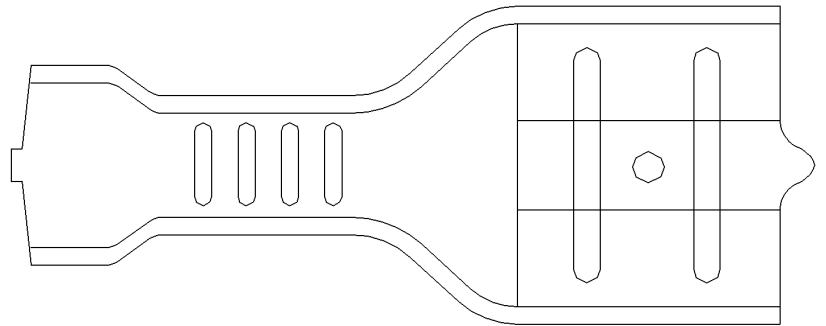

YPL10104

**(E)**

Luz/es de iluminación de la  
placa de matrícula  
Hembra  
LATON  
Capó trasero - interior

Cav	Col	Cct
1	B	ALL



# C139

## CONNECTOR / AANSLUITING / CONECTOR

(GB)

Number plate illumination  
lamp(s)  
Female  
BRASS  
Boot lid - inside

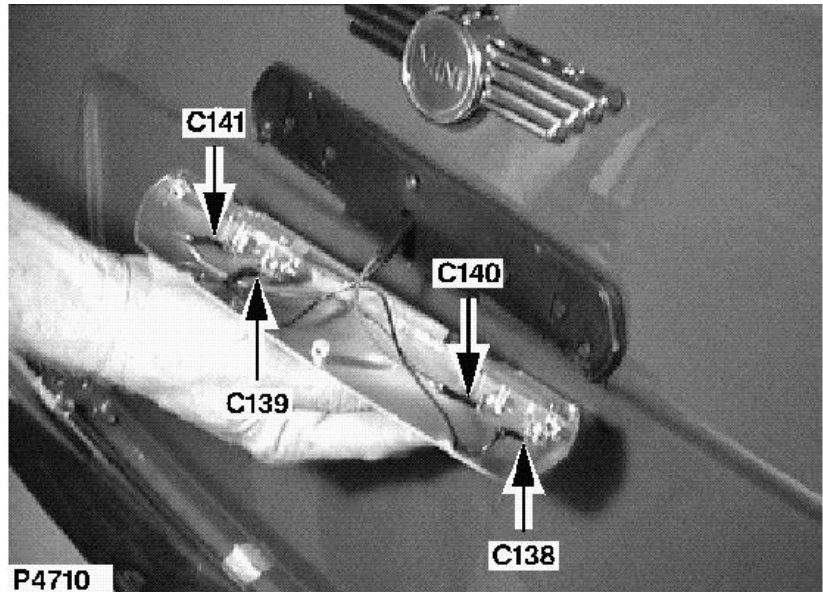

(NL)

Nummerplaatverlichting -  
lamp(en)  
Vrouwelijk  
KOPER  
Kofferdeksel - binnenkant

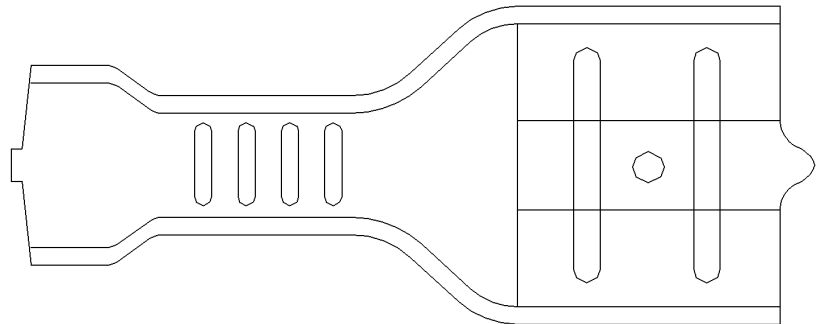

YPL10104

(E)

Luz/es de iluminación de la  
placa de matrícula  
Hembra  
LATON  
Capó trasero - interior

Cav	Col	Cct
1	B	ALL

**(GB)**

Number plate illumination  
lamp(s)  
Female  
BRASS  
Boot lid - inside

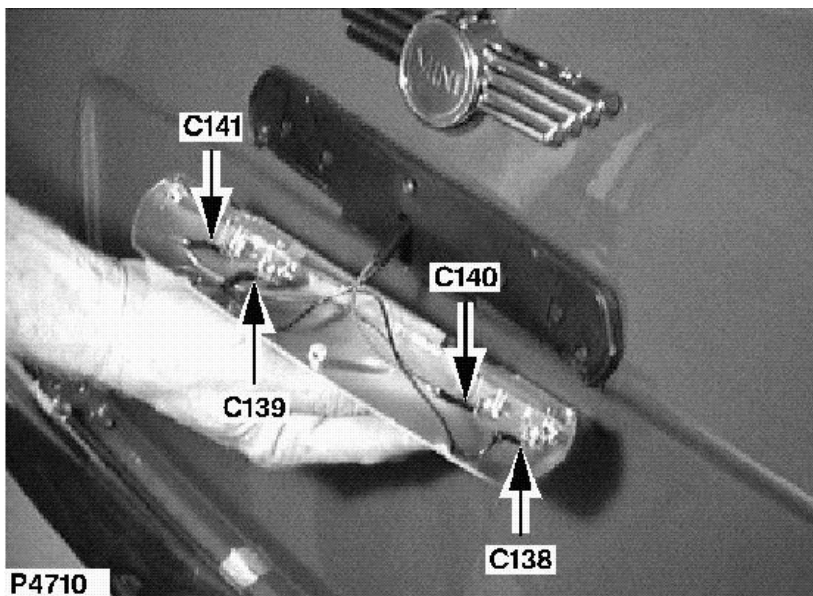

**(NL)**

Nummerplaatverlichting -  
lamp(en)  
Vrouwelijk  
KOPER  
Kofferdeksel - binnenkant

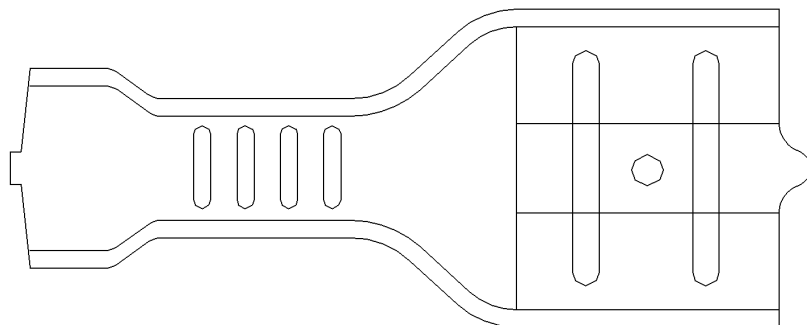

YPL10104

**(E)**

Luz/es de iluminación de la  
placa de matrícula  
Hembra  
LATON  
Capó trasero - interior

Cav	Col	Cct
1	R	ALL

# C141

## CONNECTOR / AANSLUITING / CONECTOR

(GB)

Number plate illumination  
lamp(s)  
Female  
BRASS  
Boot lid - inside

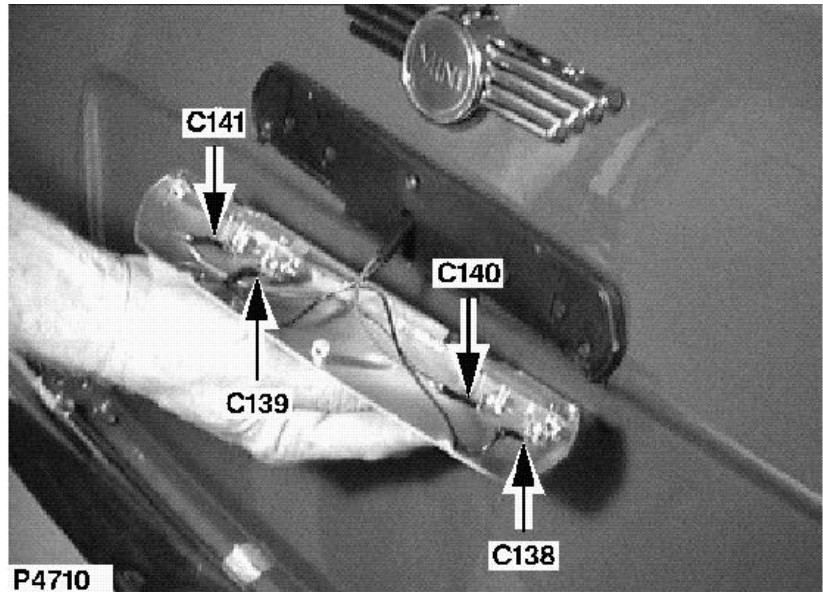

(NL)

Nummerplaatverlichting -  
lamp(en)  
Vrouwelijk  
KOPER  
Kofferdeksel - binnenkant

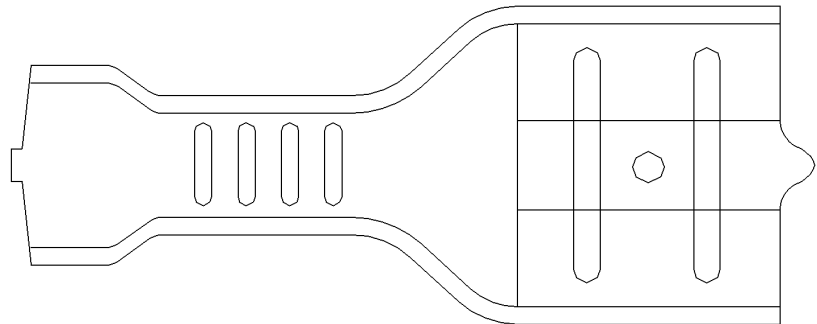

YPL10104

(E)

Luz/es de iluminación de la  
placa de matrícula  
Hembra  
LATON  
Capó trasero - interior

Cav	Col	Cct
1	R	ALL

**(GB)**

Number Plate Harness to  
Body Harness  
Male  
BLACK  
Luggage compartment lid

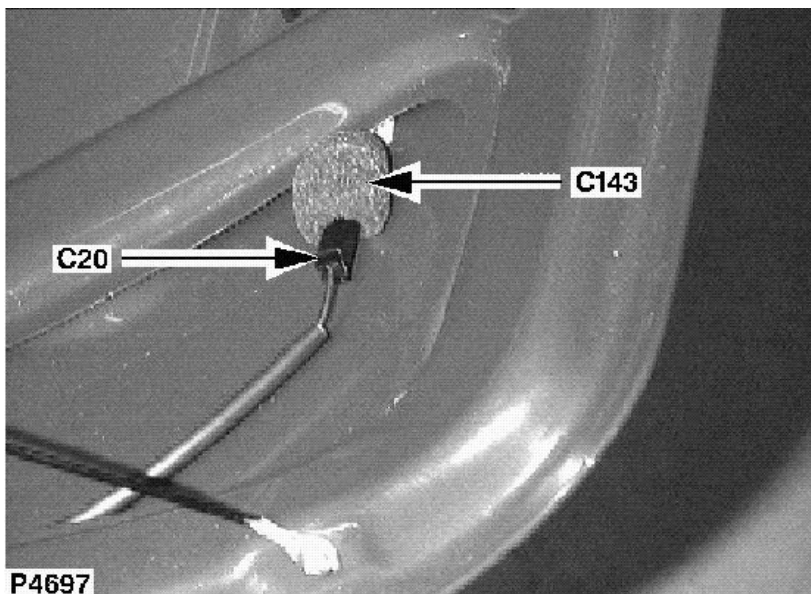
**(NL)**

Kabelbundel voor  
nummerplaat-verlichting naar  
carrosserie-kabelbundel  
Mannelijk  
ZWART  
Kofferdeksel

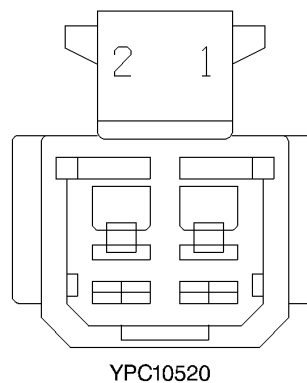
**(E)**

Mazo de cables de matrícula  
al mazo de cables de la  
carrocería  
Macho  
NEGRO  
Capó trasero

Cav	Col	Cct
1	B	ALL
2	R	ALL

# C152

## CONNECTOR / AANSLUITING / CONECTOR

**(GB)**

Purge valve  
Male  
GREY  
LH side of bulkhead

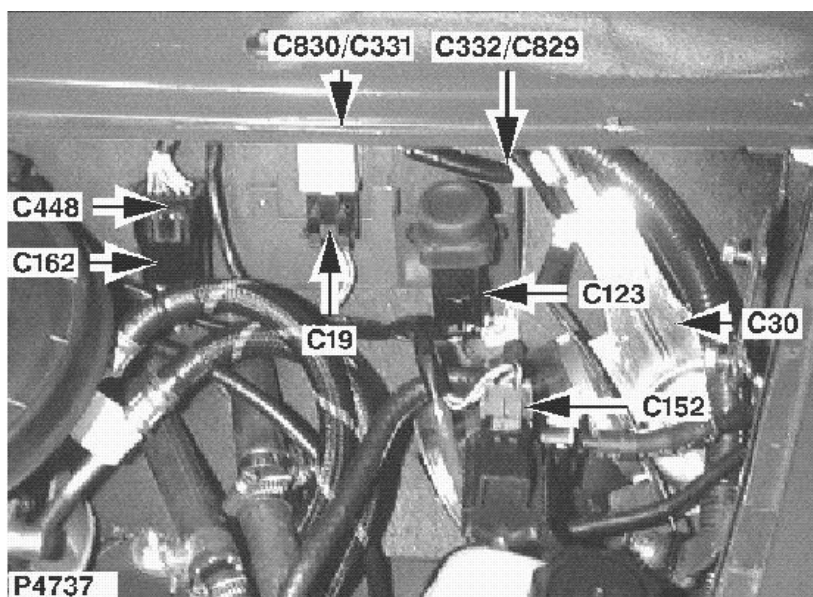

**(NL)**

Spuiklep  
Mannelijk  
LEIGRIJS  
Linkerkant tussenschot

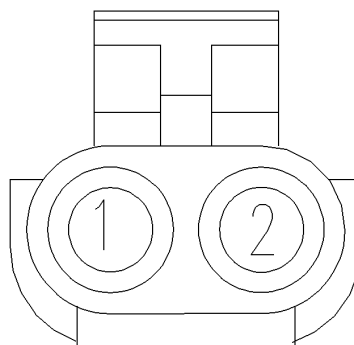

AFU3767

**(E)**

Válvula de purga  
Macho  
PIZARRO (GRIS)  
Lado izquierdo del salpicadero

Cav	Col	Cct
1	BW	ALL
2	NK	ALL

**(GB)**

Modular engine management  
(MEMS) relay module  
Female  
BLACK  
Rear RH side of engine  
compartment

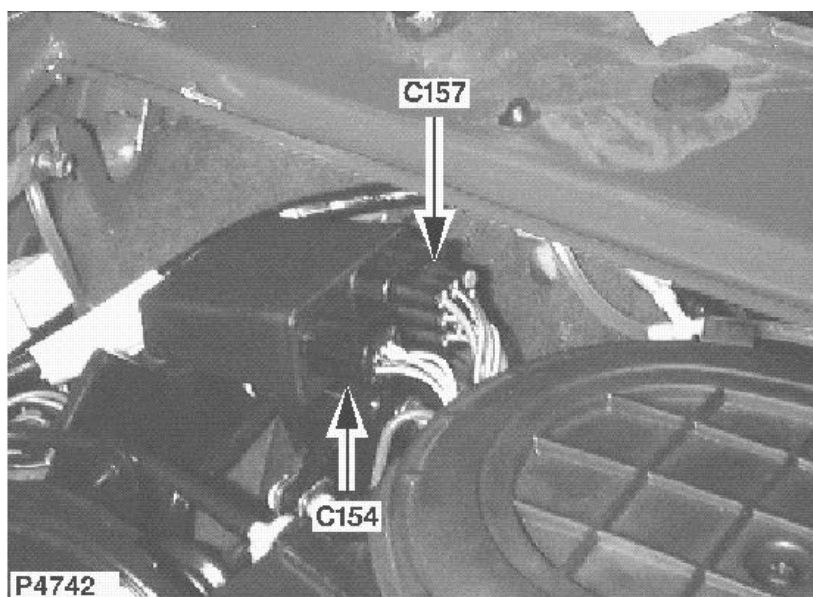
**(NL)**

Modulair motor-  
managementsysteem  
(MEMS) - relais-module  
Vrouwelijk  
ZWART  
Rechter achterkant  
motorcompartiment

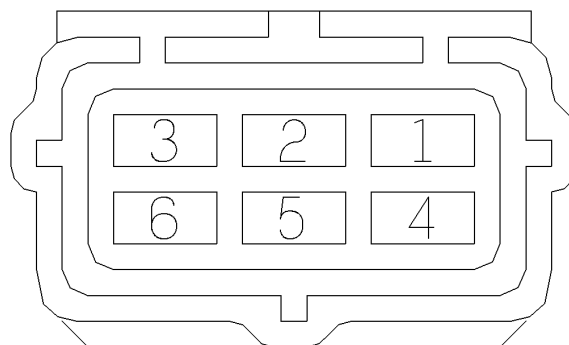

YPC10064

**(E)**

Módulo de relés de gestión  
del motor (MEMS)  
Hembra  
NEGRO  
Parte trasera derecha del  
compartimento motor

Cav	Col	Cct
1	BP	ALL
2	W	ALL
3	WK	ALL
4	WR	ALL
5	BG	ALL
6	WK	ALL

**(GB)**

Modular engine management  
(MEMS) relay module  
Female  
BLACK  
Rear RH side of engine  
compartment

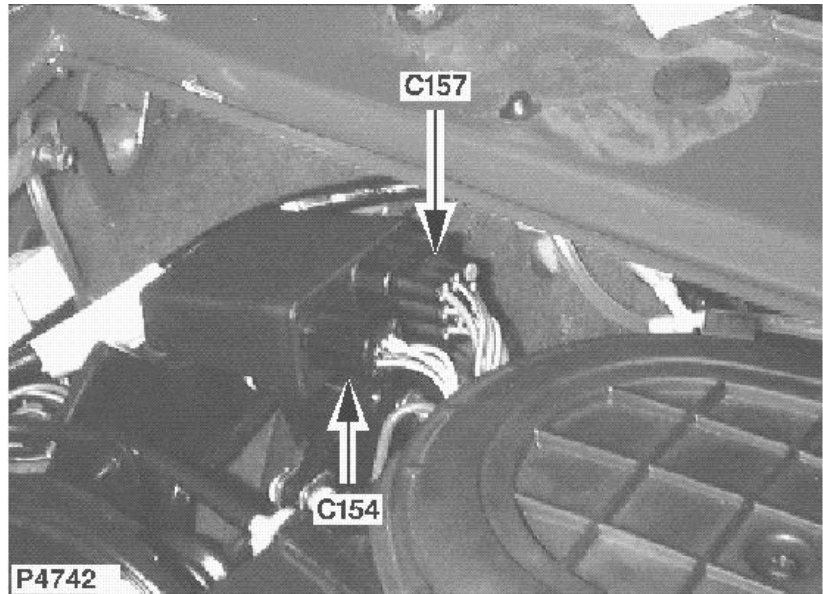

**(NL)**

Modulair motor-  
managementsysteem  
(MEMS) - relais-module  
Vrouwelijk  
ZWART  
Rechter achterkant  
motorcompartiment

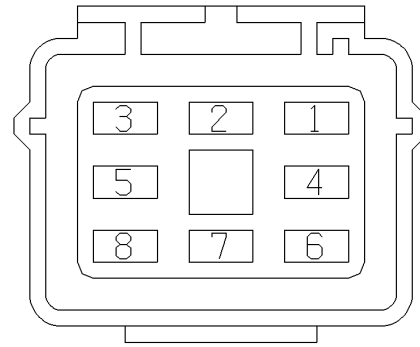

AFU3822

**(E)**

Módulo de relés de gestión  
del motor (MEMS)  
Hembra  
NEGRO  
Parte trasera derecha del  
compartimento motor

Cav	Col	Cct
1	N	ALL
2	UR	ALL
4	NS	ALL
5	NR	ALL
6	N	ALL
7	N	ALL
8	NK	ALL

**(GB)**

Modular engine management control unit  
 Female  
 RED  
 RH side of engine compartment

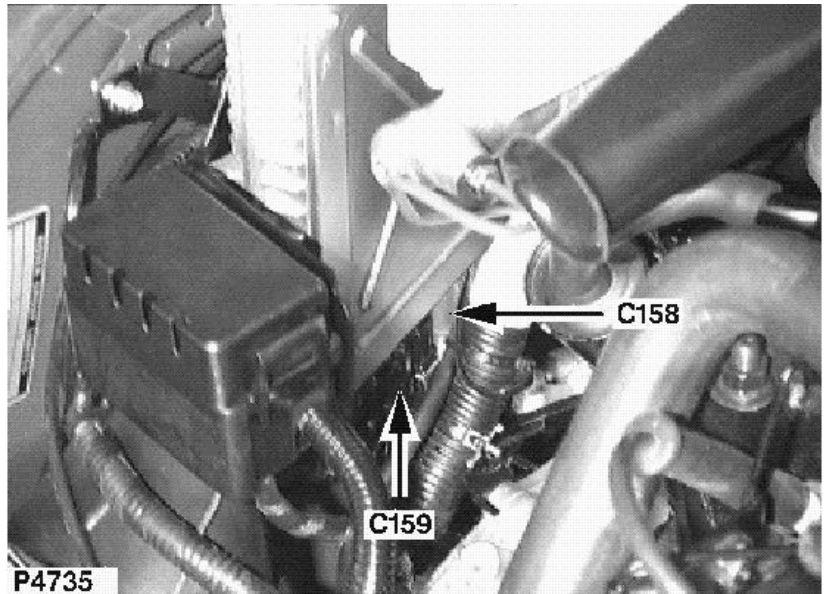

**(NL)**

Modulair motor-managementsysteem - regeleenheid  
 Vrouwelijk  
 ROOD  
 Rechterkant motorcompartiment

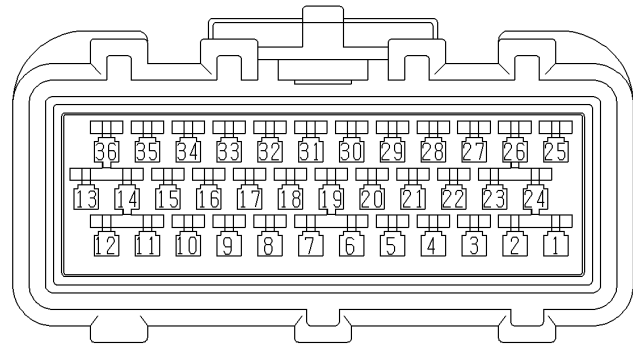

YPC10530

**(E)**

Unidad de control modular de gestión del motor  
 Hembra  
 ROJO  
 Lado derecho del compartimento motor

Cav	Col	Cct	Cav	Col	Cct	Cav	Col	Cct
1	RY	ALL	16	B	ALL	28	LGS	ALL
2	BU	ALL	17	BW	ALL	31	WY	ALL
10	OG	ALL	23	B	ALL	33	KU	ALL
12	YN	ALL	24	B	ALL	34	OS	ALL
13	YN	ALL	25	UP	ALL	35	YR	ALL
14	YR	ALL	26	WU	ALL			
15	OU	ALL	27	S	ALL			



# C159

## CONNECTOR / AANSLUITING / CONECTOR

**(GB)**

Modular engine management control unit  
Female  
BLACK  
RH side of engine compartment

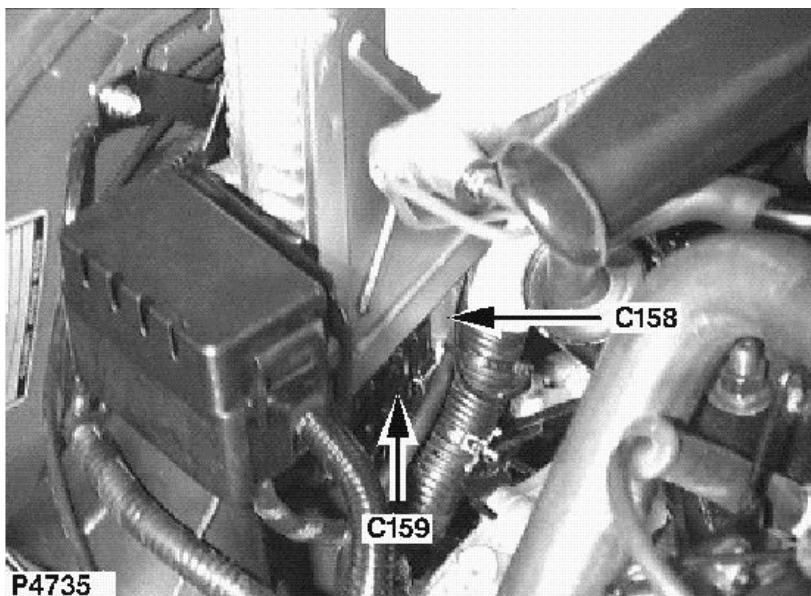

**(NL)**

Modulair motor-managementsysteem - regeleenheid  
Vrouwelijk  
ZWART  
Rechterkant motorcompartiment

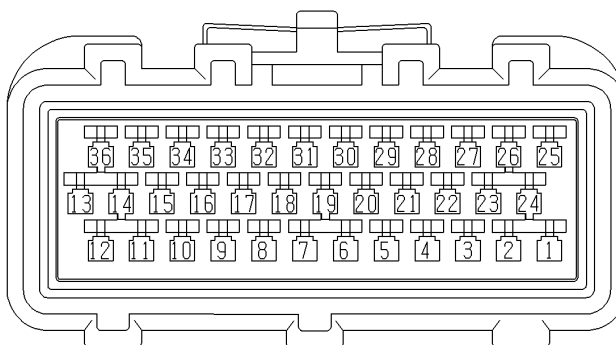

YPC10073

**(E)**

Unidad de control modular de gestión del motor  
Hembra  
NEGRO  
Lado derecho del compartimento motor

Cav	Col	Cct	Cav	Col	Cct	Cav	Col	Cct
8	YP	ALL	18	YP	ALL	27	NK	ALL
12	YG	ALL	20	BG	ALL	28	LGB	ALL
13	KB	ALL	21	B	ALL	30	BP	ALL
14	GB	ALL	22	WK	ALL	31	KG	ALL
15	KG	ALL	25	WB	ALL	33	W	ALL
17	WS	ALL	26	WS	ALL	36	RG	ALL

**(GB)**

Engine Harness to Main  
Harness  
Male  
BLACK  
LH side of bulkhead

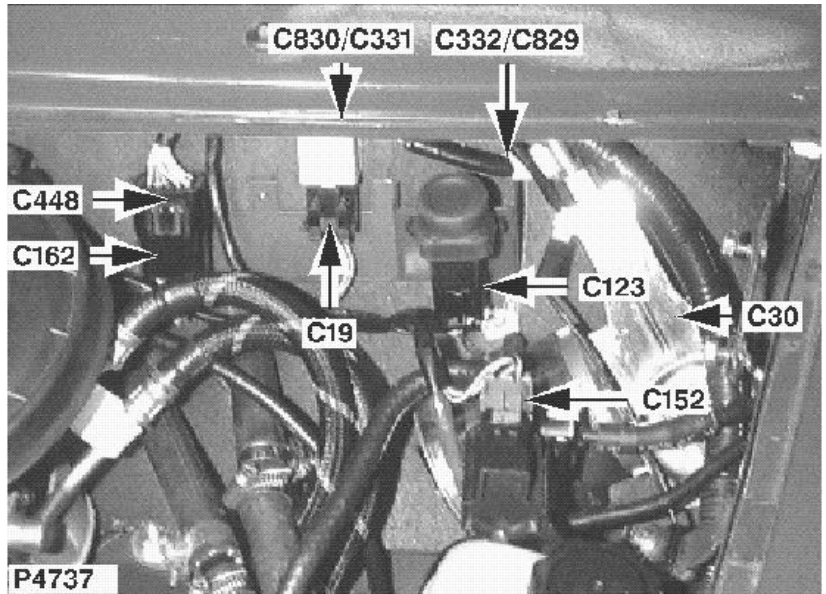

**(NL)**

Motor-kabelbundel naar  
hoofdkabelbundel  
Mannelijk  
ZWART  
Linkerkant tussenschot

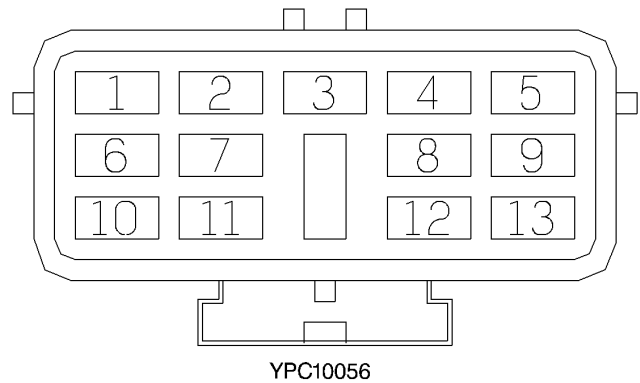

**(E)**

Mazo de cables motor al  
mazo de cables principal  
Macho  
NEGRO  
Lado izquierdo del  
salpicadero

Cav	Col	Cct	Cav	Col	Cct
1	W	ALL	7	NY	ALL
2	WK	ALL	8	WN	ALL
3	KG	ALL	9	LGB	ALL
4	NS	ALL	10	WR	ALL
5	WS	ALL	11	WY	ALL
6	WB	ALL	12	NU	ALL

# C164

## CONNECTOR / AANSLUITING / CONECTOR

**(GB)**

Oxygen sensor  
Female  
BLACK  
Rear of engine compartment -  
centre

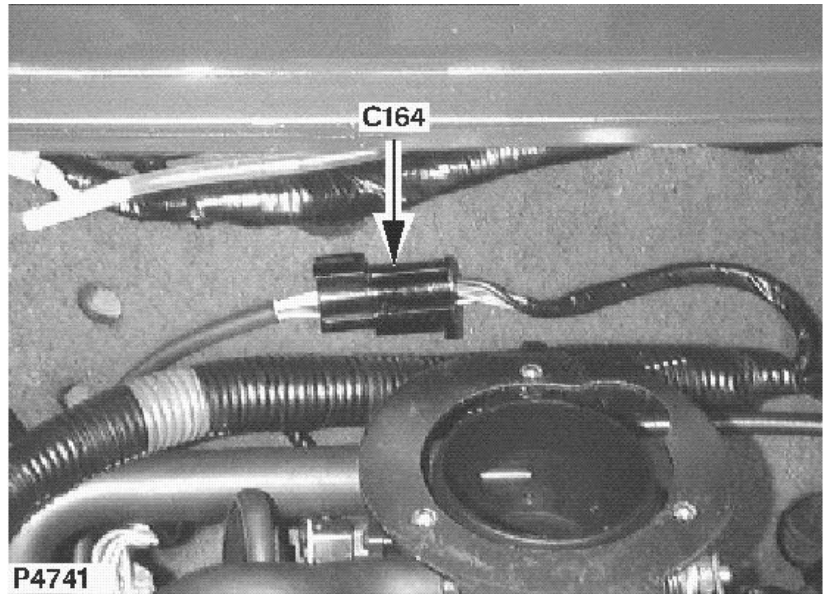

**(NL)**

Zuurstofsensor  
Vrouwelijk  
ZWART  
achterkant  
motorcompartiment - midden

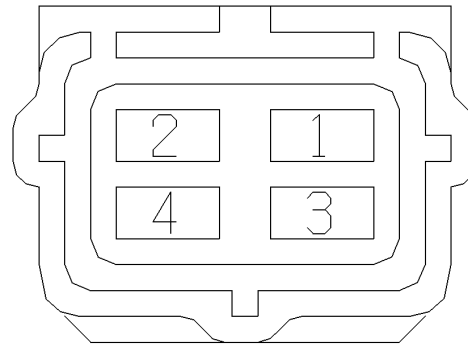

YPC10066

**(E)**

Sensor de oxígeno  
Hembra  
NEGRO  
parte trasera del  
compartimento motor - centro

Cav	Col	Cct
1	S	ALL
2	LGS	ALL
3	B	ALL
4	UR	ALL

**(GB)**

Reverse lamp switch  
 Female  
 WHITE  
 Beneath footwell carpet - RH  
 side

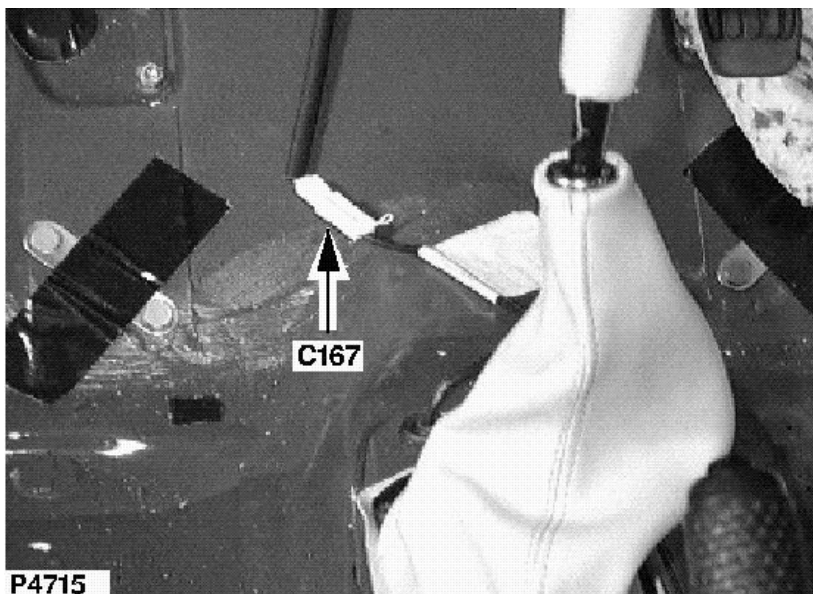
**(NL)**

Achteruitrijlamp - schakelaar  
 Vrouwelijk  
 WIT  
 onder vloerbedekking -  
 Rechts

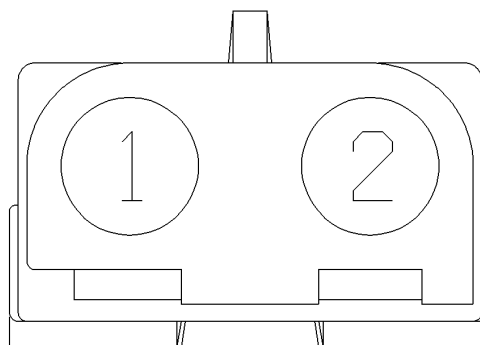

AFU4458

**(E)**

Interruptor del piloto de  
 marcha atrás  
 Hembra  
 BLANCO  
 debajo de la moqueta del  
 hueco para los pies - Lado  
 derecho

Cav	Col	Cct
1	G	ALL
2	GN	ALL

# C168

## CONNECTOR / AANSLUITING / CONECTOR

(GB)

Crankshaft sensor

Female

BLUE

Lower front of engine - RH side

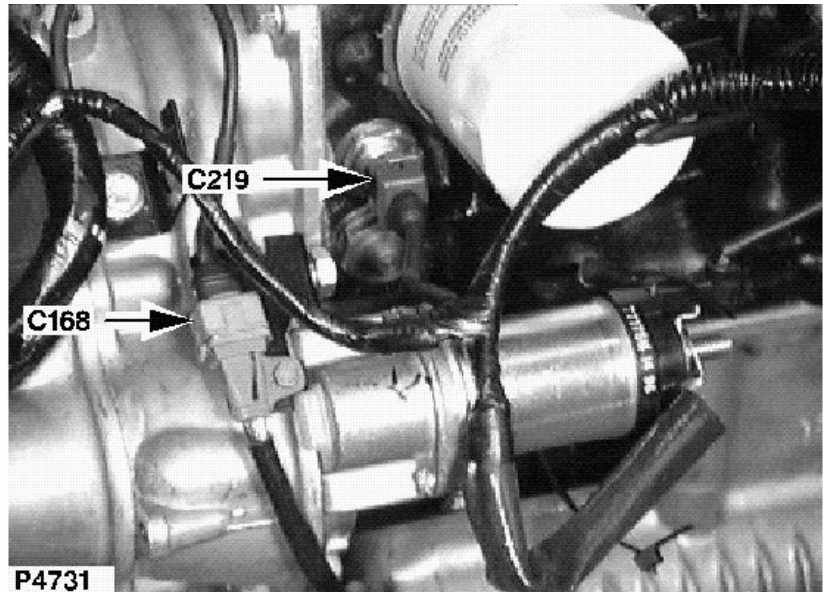

(NL)

Kruksensor

Vrouwelijk

BLAUW

Onder/voorkant motor -

Rechts

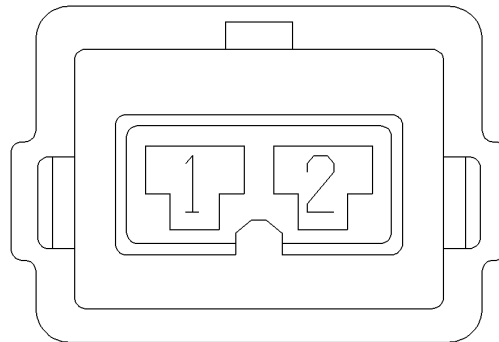

ALU1035

(E)

Sensor del cigüeñal

Hembra

AZUL

Parte delantera inferior del motor - Lado derecho

Cav	Col	Cct
1	WU	ALL
2	UP	ALL

**(GB)**

Coolant temperature (tw)  
sensor  
Female  
BROWN  
LH side of engine

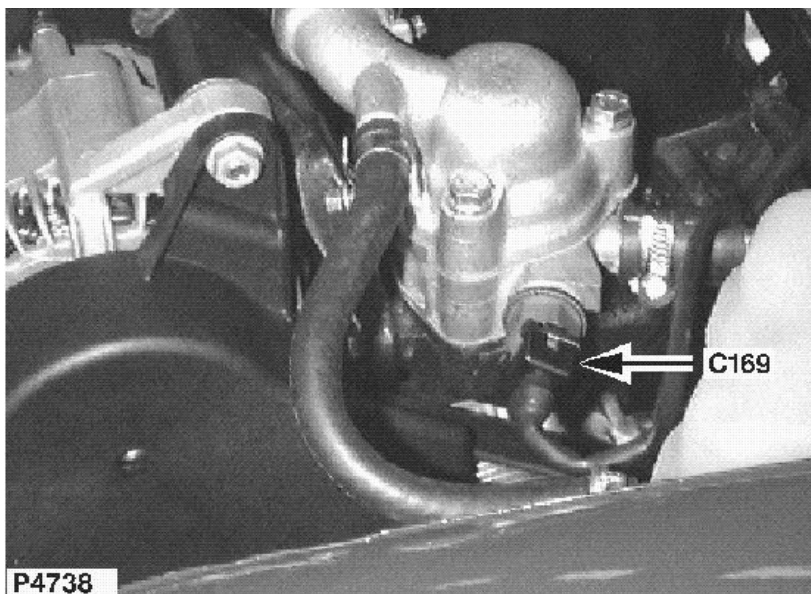
**(NL)**

Koelvloeistoftemperatuur (tw)  
- sensor  
Vrouwelijk  
BRUIN  
Linkerkant motor

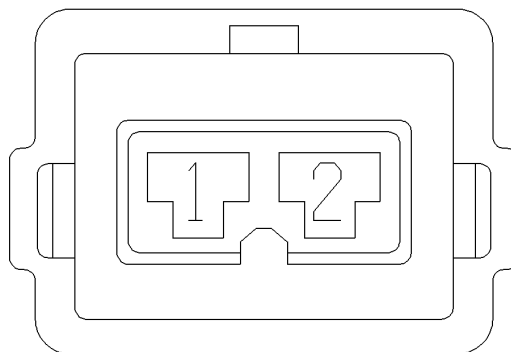

ALU1036

**(E)**

Sensor de temperatura de  
refrigerante (tw)  
Hembra  
MARRON  
Lado izquierdo del motor

Cav	Col	Cct
1	KB	ALL
2	KG	ALL

# C174

## CONNECTOR / AANSLUITING / CONECTOR

**(GB)**

Inlet air temperature (ta)  
sensor  
Female  
GREEN  
Top rear of engine - centre

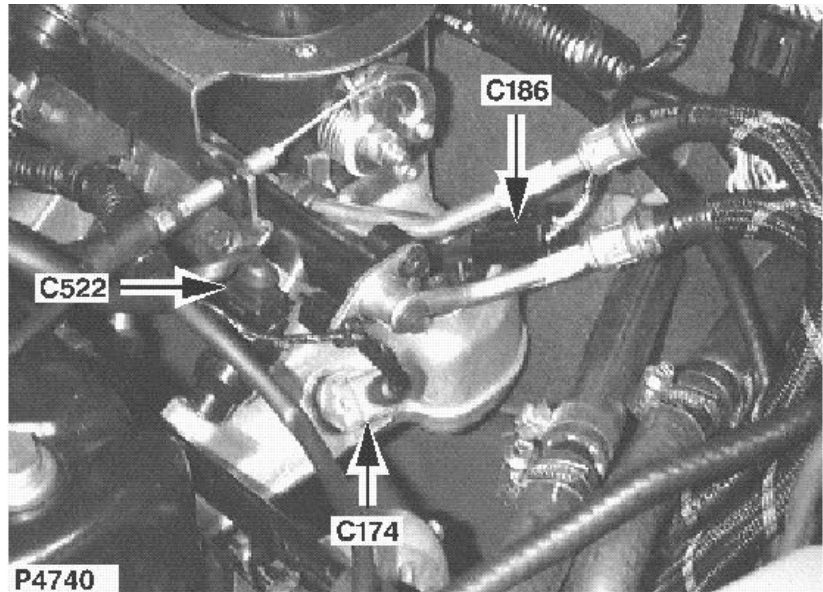

**(NL)**

Inlaatluchttemperatuur (ta) -  
sensor  
Vrouwelijk  
GROEN  
boven/achterkant motor -  
midden

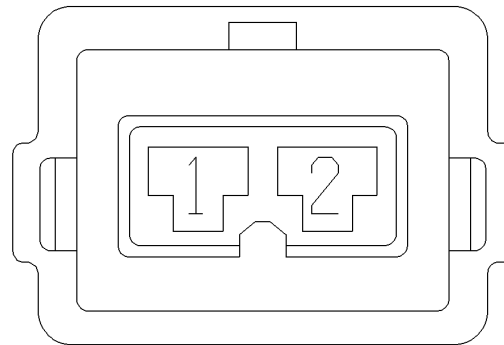

AFU3108

**(E)**

Sensor de temperatura del  
aire de admisión (ta)  
Hembra  
VERDE  
parte superior trasera del  
motor - centro

Cav	Col	Cct
1	KB	ALL
2	GB	ALL

**(GB)**

Throttle position sensor  
 Female  
 BLACK  
 Top rear of engine - centre

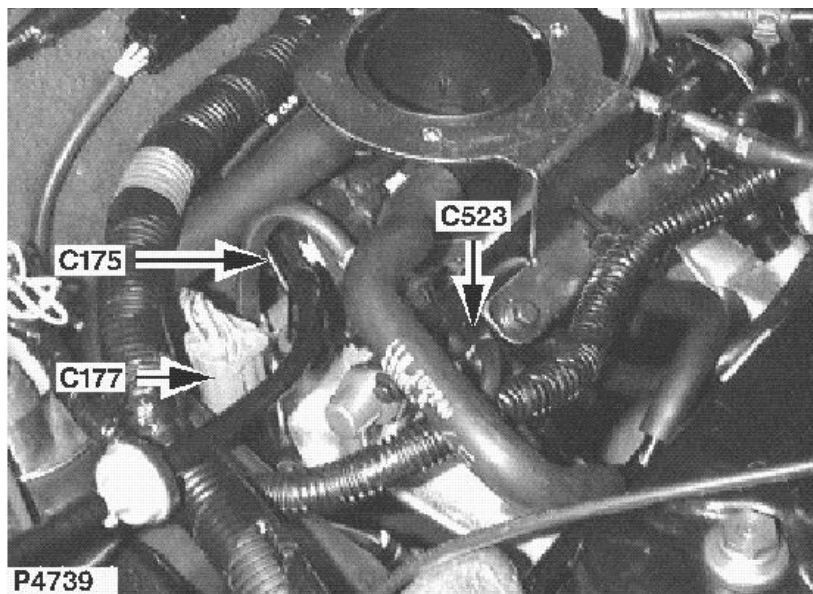
**(NL)**

Gaspedaalpositie - sensor  
 Vrouwelijk  
 ZWART  
 boven/achterkant motor -  
 midden

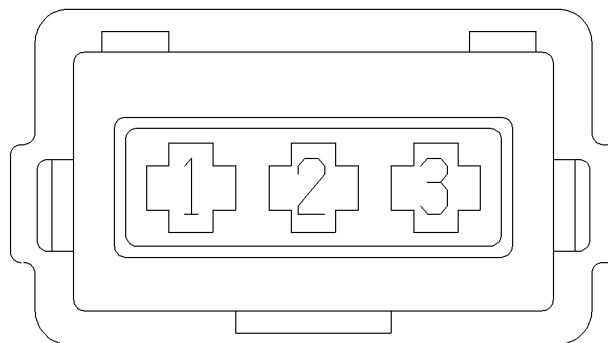

YPC10512

**(E)**

Sensor de posición del pedal  
 de acelerador  
 Hembra  
 NEGRO  
 parte superior trasera del  
 motor - centro

Cav	Col	Cct
1	YP	ALL
2	YG	ALL
3	KB	ALL



# C176

## CONNECTOR / AANSLUITING / CONECTOR

**(GB)**

Camshaft sensor  
Female  
BLACK  
Lower rear of engine - centre

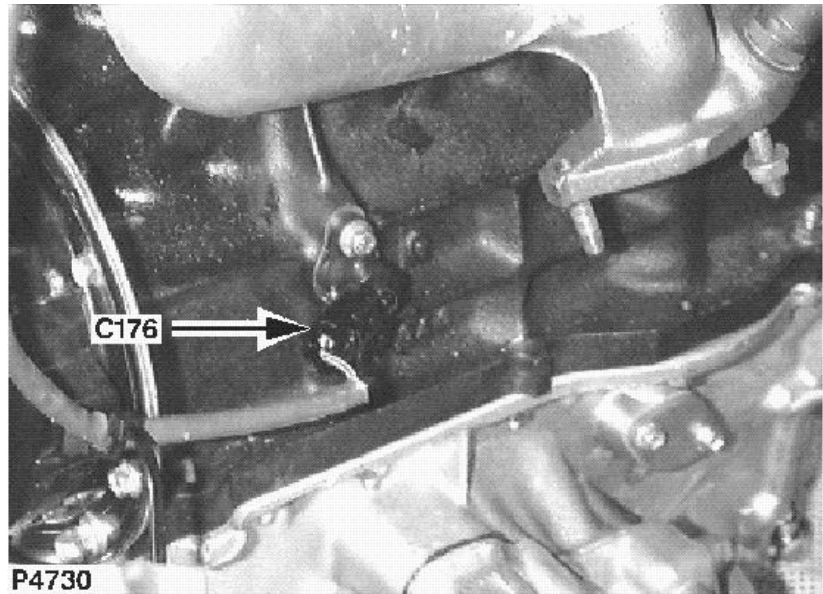

**(NL)**

Nokkenas - sensor  
Vrouwelijk  
ZWART  
onder/achterkant motor -  
midden

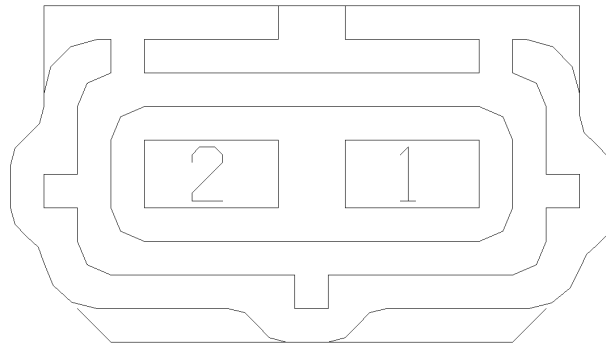

YPC10070

**(E)**

Sensor del árbol de levas  
Hembra  
NEGRO  
parte inferior trasera del  
motor - centro

Cav	Col	Cct
1	BU	ALL
2	RY	ALL

**(GB)**

Stepper motor  
 Female  
 BLUE  
 Top rear of engine - centre

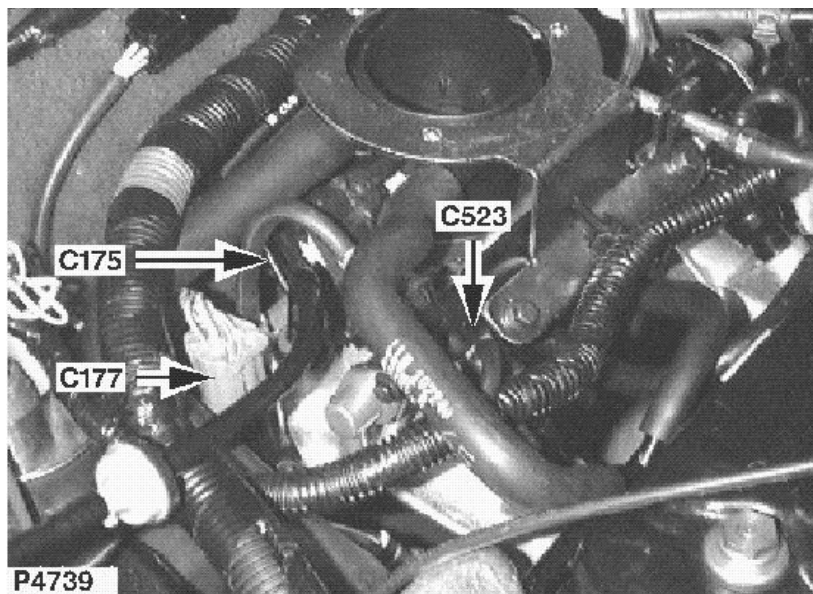

**(NL)**

Stepper-motor  
 Vrouwelijk  
 BLAUW  
 boven/achterkant motor -  
 midden

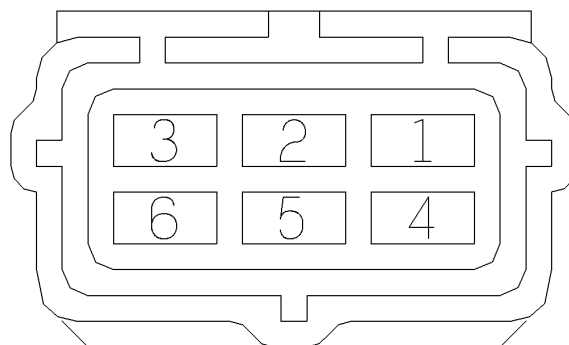

YPC10196

**(E)**

Motor paso a paso  
 Hembra  
 AZUL  
 parte superior trasera del  
 motor - centro

Cav	Col	Cct
1	OS	ALL
2	NK	ALL
3	KU	ALL
4	OU	ALL
6	OG	ALL

# C178

## CONNECTOR / AANSLUITING / CONECTOR

(GB)

Starter motor/solenoid  
Eyelet  
TIN-PLATE  
Lower front of engine - RH  
side

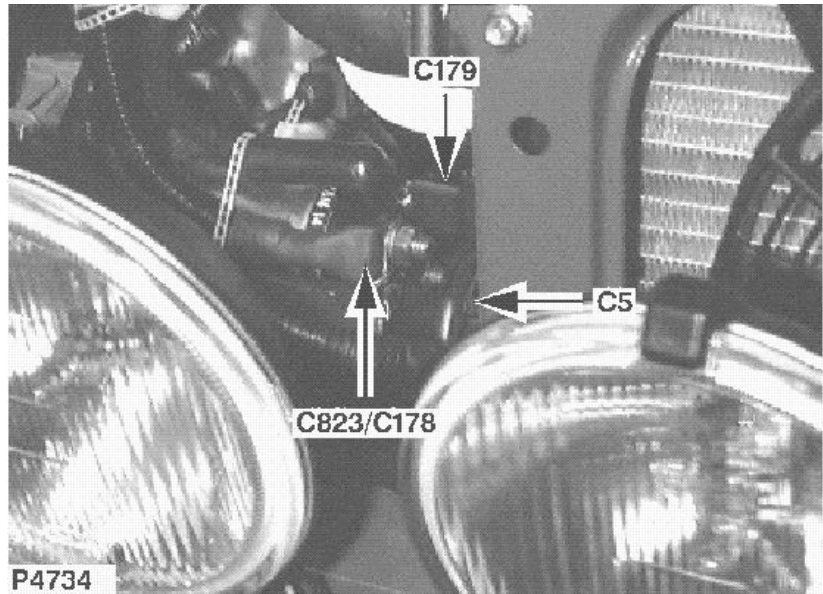

(NL)

Startmotor/solenoid  
Oogje  
VERTIND  
Onder/voorkant motor -  
Rechts

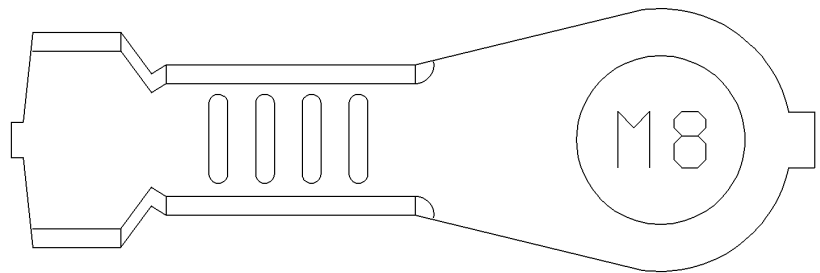

YPG10015

(E)

Motor/solenoid de arranque  
Ollao  
PLACA ESTAÑO  
Parte delantera inferior del  
motor - Lado derecho

Cav	Col	Cct
1	N	ALL

**(GB)**

Starter motor/solenoid  
 Female  
 BLACK  
 Lower front of engine - RH  
 side

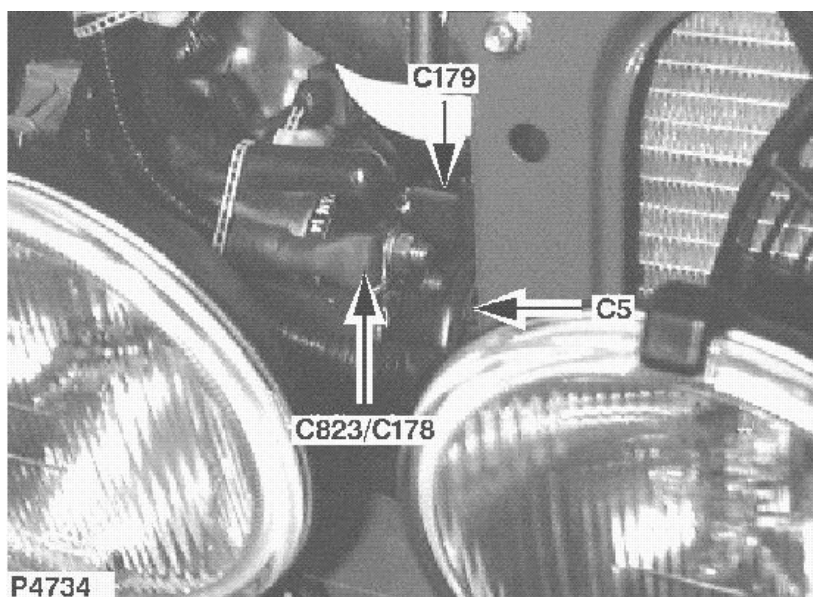
**(NL)**

Startmotor/solenoid  
 Vrouwelijk  
 ZWART  
 Onder/voorkant motor -  
 Rechts

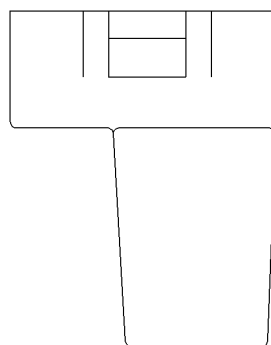

YPQ100680

**(E)**

Motor/solenoid de arranque  
 Hembra  
 NEGRO  
 Parte delantera inferior del  
 motor - Lado derecho

Cav	Col	Cct
1	NR	ALL

# C183

## CONNECTOR / AANSLUITING / CONECTOR

(GB)

Alternator  
Eyelet  
BRASS, TIN-PLATED  
Front of engine - centre

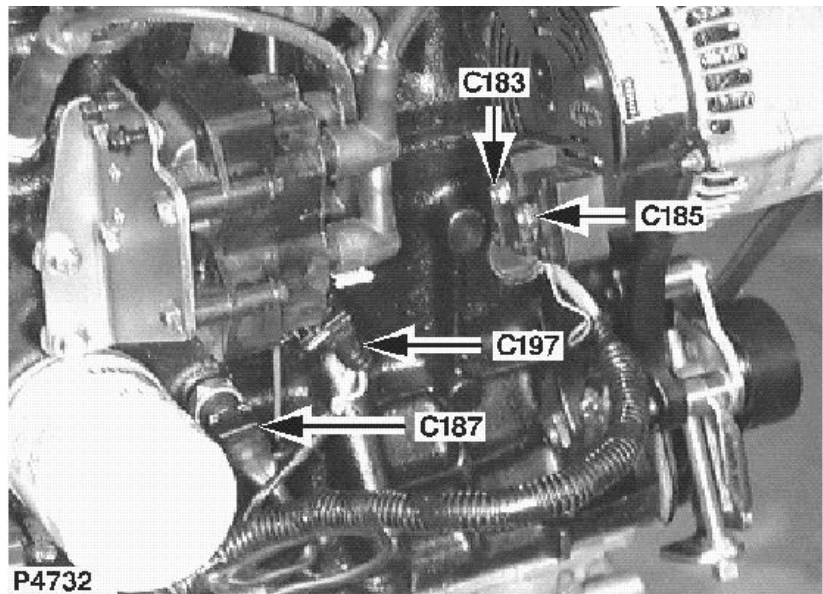

(NL)

Wisselstroomdynamo  
Oogje  
KOPER  
Voorkant motor - midden

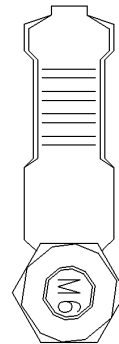

YPG10058

(E)

Alternador  
Ollao  
LATON  
Parte delantera del motor -  
centro

Cav	Col	Cct
1	NP	ALL

**(GB)**

Alternator output  
Eyelet  
BRASS  
Front of engine - centre

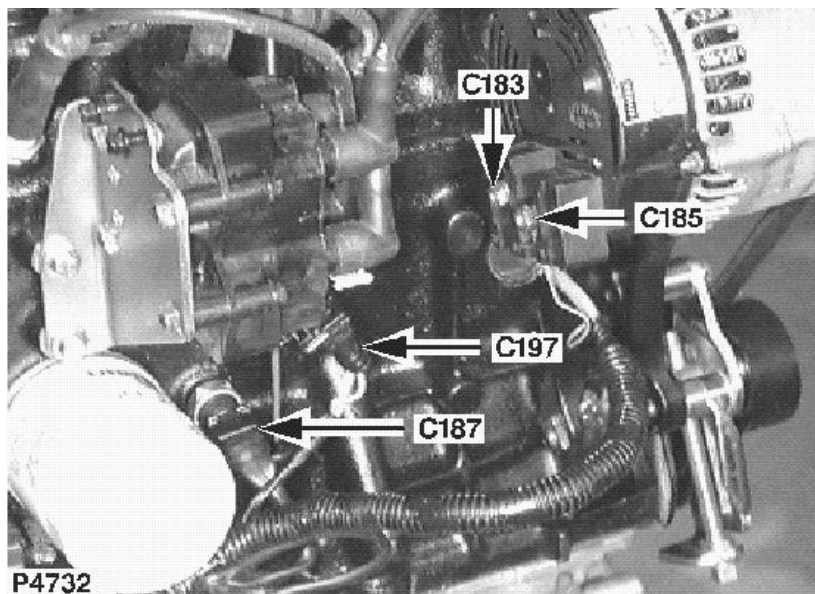

**(NL)**

Wisselstroomdynamo -  
uitvoer  
Oogje  
KOPER  
Voorkant motor - midden

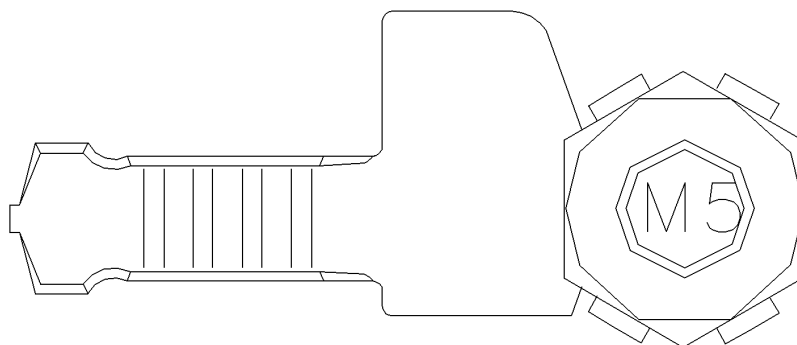

YPG10044

**(E)**

Salida del alternador  
Ollao  
LATON  
Parte delantera del motor -  
centro

Cav	Col	Cct
1	NY	ALL

# C186

## CONNECTOR / AANSLUITING / CONECTOR

**(GB)**

Map sensor  
Female  
BLACK  
Top rear of engine - centre

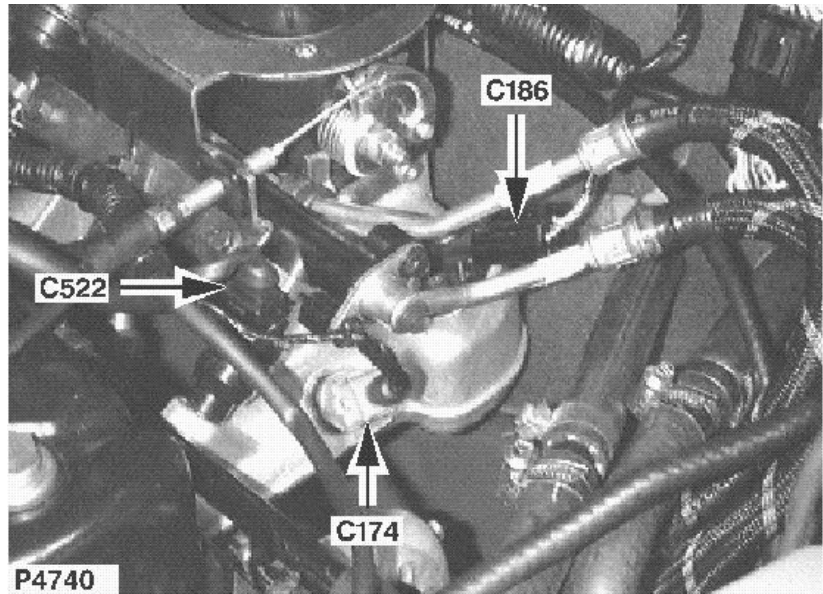

**(NL)**

Map-sensor  
Vrouwelijk  
ZWART  
boven/achterkant motor -  
midden

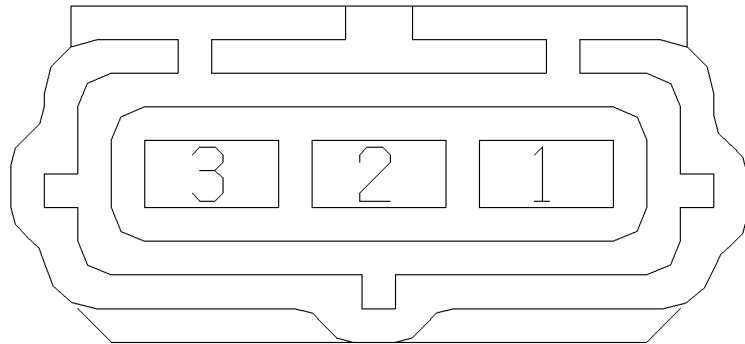

YPC10068

**(E)**

Sensor map  
Hembra  
NEGRO  
parte superior trasera del  
motor - centro

Cav	Col	Cct
1	KB	ALL
2	RG	ALL
3	YP	ALL

**(GB)**

Oil pressure switch  
 Female  
 BLACK  
 Front of engine - centre

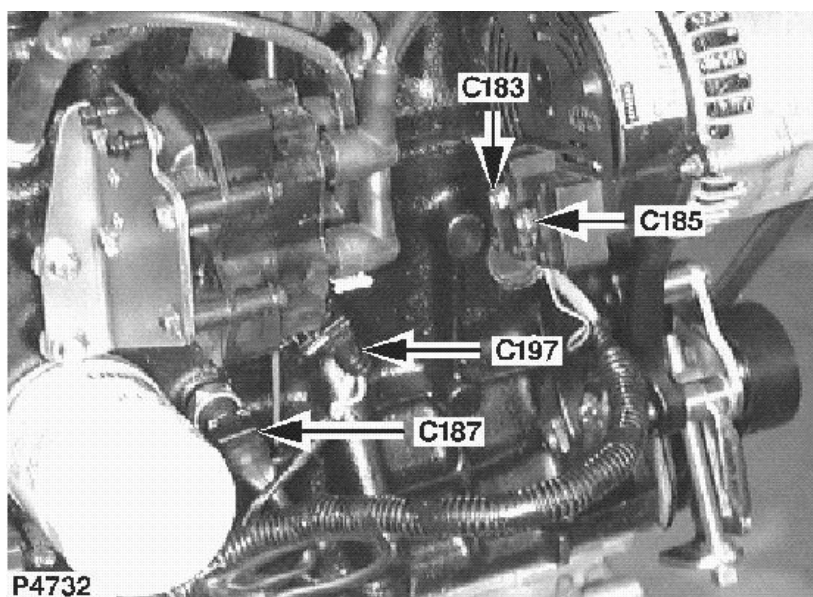
**(NL)**

Oliedrukschakelaar  
 Vrouwelijk  
 ZWART  
 Voorkant motor - midden

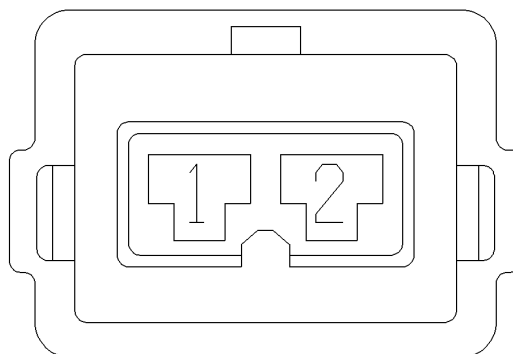

ALU1038

**(E)**

Presostato de aceite  
 Hembra  
 NEGRO  
 Parte delantera del motor -  
 centro

Cav	Col	Cct
1	WN	ALL



# C197

## CONNECTOR / AANSLUITING / CONECTOR

(GB)

Ignition coil  
Female  
BLACK  
Front of engine - centre

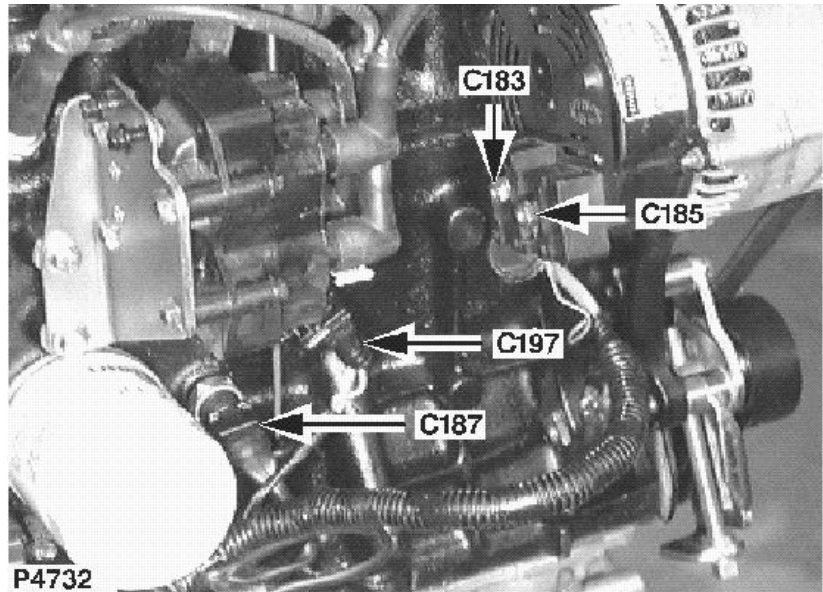

(NL)

Bobine  
Vrouwelijk  
ZWART  
Voorkant motor - midden

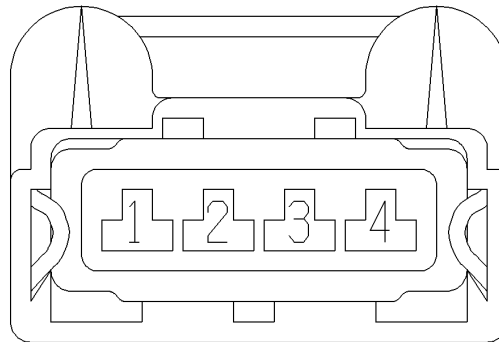

YPC10511

(E)

Bobina de encendido  
Hembra  
NEGRO  
Parte delantera del motor -  
centro

Cav	Col	Cct
1	WB	ALL
2	WS	ALL
3	NK	ALL

**(GB)**

Fuel pump  
 Female  
 NATURAL  
 Luggage compartment - LH  
 side

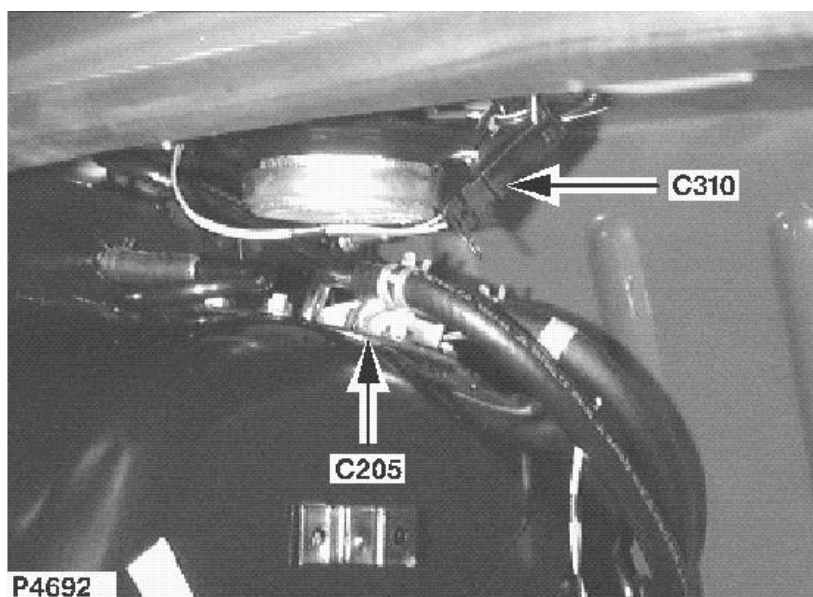
**(NL)**

Brandstofpomp  
 Vrouwelijk  
 NATUREL  
 bagageruimte - Links

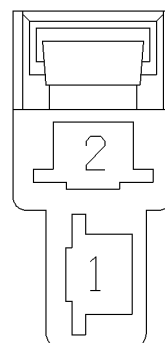

AFU3555

**(E)**

Bomba de combustible  
 Hembra  
 NATURAL  
 maletero - Lado izquierdo

Cav	Col	Cct
1	B	ALL
2	WP	ALL

# C210

## CONNECTOR / AANSLUITING / CONECTOR

(GB)

Clock  
Female  
PHOS-BRON  
Behind centre of fascia

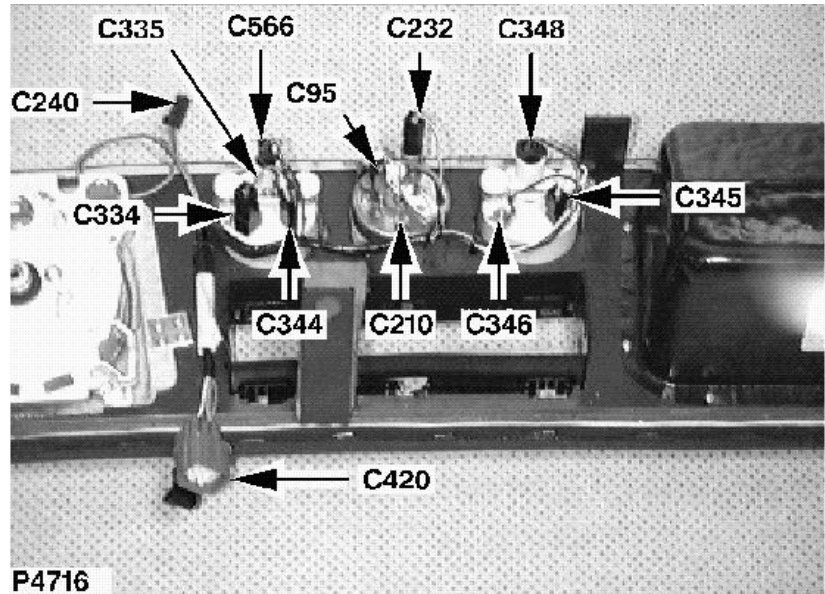

(NL)

Klok  
Vrouwelijk  
FOSFORBRONS  
achter middelste gedeelte  
dashboard

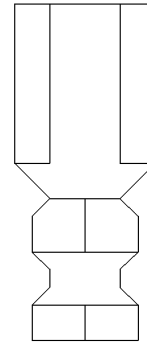

ADU9185

(E)

Reloj  
Hembra  
BRONCE FOSFOROSO  
detrás de la parte central del  
tablero

Cav	Col	Cct
1	B	ALL

**(GB)**

Auxiliary relay  
Female  
YELLOW  
Behind centre of fascia

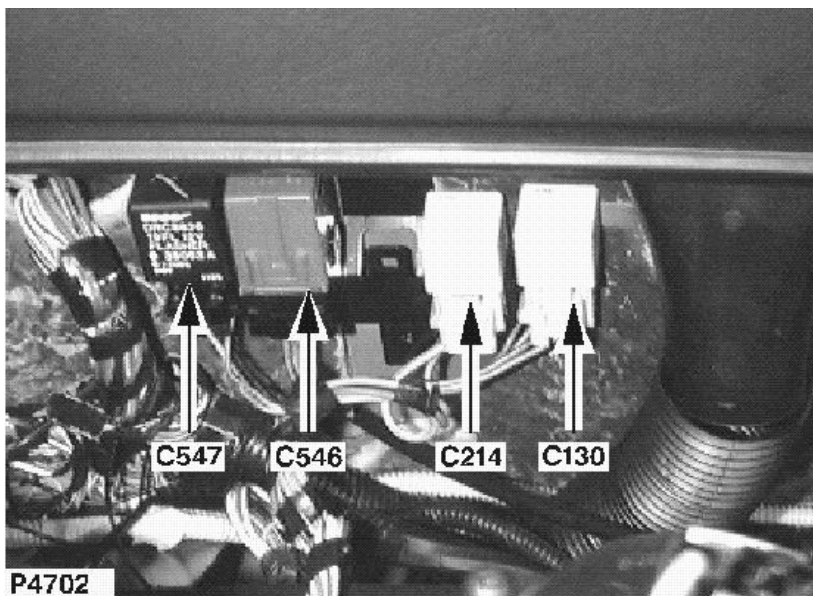
**(NL)**

Hulprelais  
Vrouwelijk  
GEEL  
achter middelste gedeelte  
dashboard

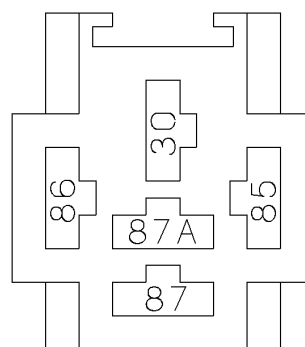

AFU3271

**(E)**

Relé auxiliar  
Hembra  
AMARILLO  
detrás de la parte central del  
tablero

Cav	Col	Cct
30	N	ALL
85	LG	ALL
86	B	ALL
87	LGW	ALL

# C219

## CONNECTOR / AANSLUITING / CONECTOR

**(GB)**

Oil temperature sensor  
Female  
BROWN  
Lower front of engine - RH  
side

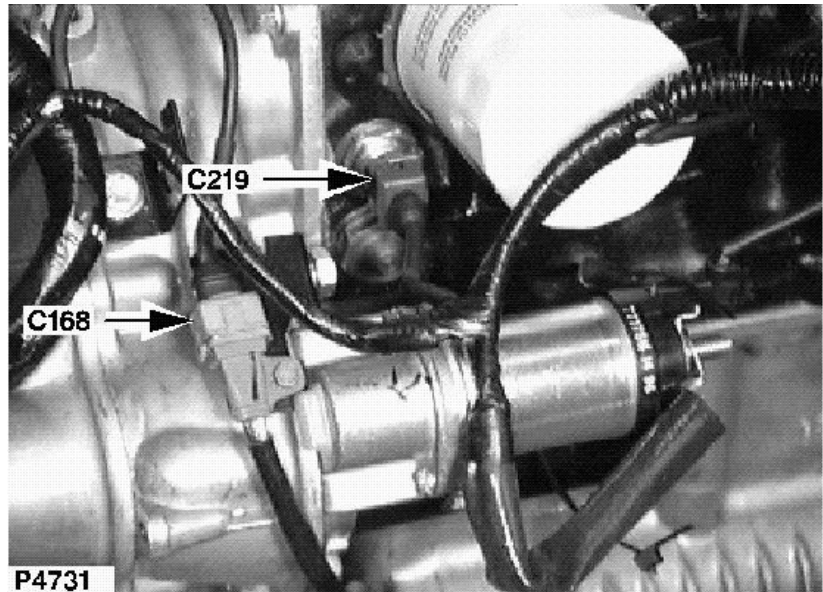

**(NL)**

Olietemperatuur - sensor  
Vrouwelijk  
BRUIN  
Onder/voorkant motor -  
Rechts

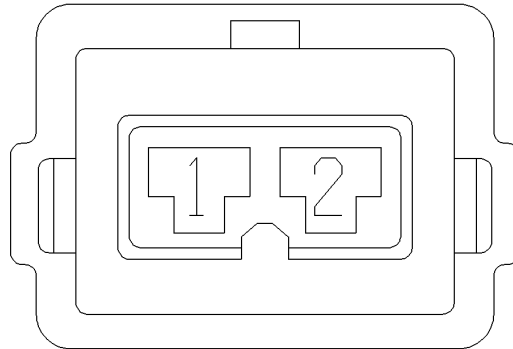

ALU1036

**(E)**

Sensor de temperatura del  
aceite  
Hembra  
MARRON  
Parte delantera inferior del  
motor - Lado derecho

Cav	Col	Cct
1	NU	ALL

**(GB)**

Boot switch  
 Female  
 BLACK  
 Luggage compartment - RH  
 side

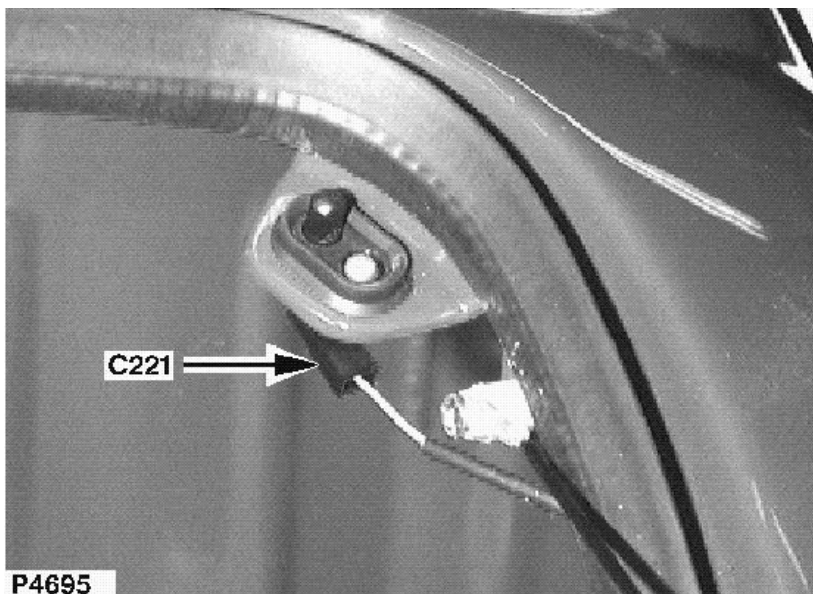
**(NL)**

Kofferdeksel - schakelaar  
 Vrouwelijk  
 ZWART  
 bagageruimte - Rechts

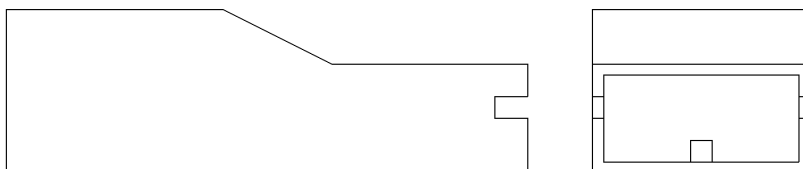

AAU1010

**(E)**

Interruptor del maletero  
 Hembra  
 NEGRO  
 maletero - Lado derecho

Cav	Col	Cct
1	PK	ALL

# C230

## CONNECTOR / AANSLUITING / CONECTOR

**(GB)**

Instrument pack  
Female  
BLACK  
Behind RH side of fascia

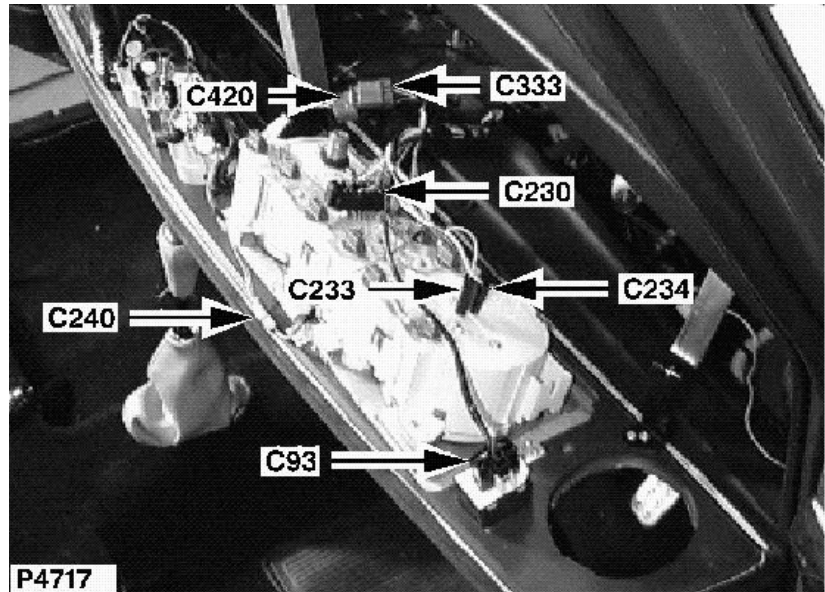

**(NL)**

Combinatie-instrument  
Vrouwelijk  
ZWART  
Achter rechterkant dashboard

**(E)**

Grupo de instrumentos  
Hembra  
NEGRO  
Detrás del lado derecho del  
tablero

Cav	Col	Cct	Cav	Col	Cct
1	GW	ALL	7	P	ALL
2	GB	ALL	8	W	ALL
3	GU	ALL	10	NY	ALL
4	UW	ALL	11	WN	ALL
5	B	ALL	12	RW	ALL
6	GR	ALL			

**(GB)**

Clock  
 Female  
 BLACK  
 Behind centre of fascia

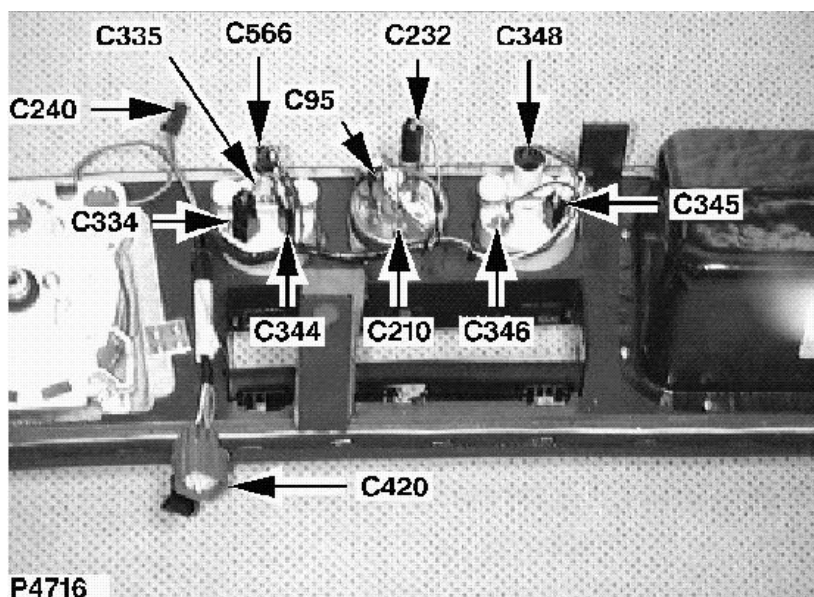
**(NL)**

Klok  
 Vrouwelijk  
 ZWART  
 achter middelste gedeelte  
 dashboard

**(E)**

Reloj  
 Hembra  
 NEGRO  
 detrás de la parte central del  
 tablero

Cav	Col	Cct
1	RW	ALL
2	B	ALL



# C233

## CONNECTOR / AANSLUITING / CONECTOR

(GB)

Instrument pack  
Female  
BLACK  
Behind RH side of fascia

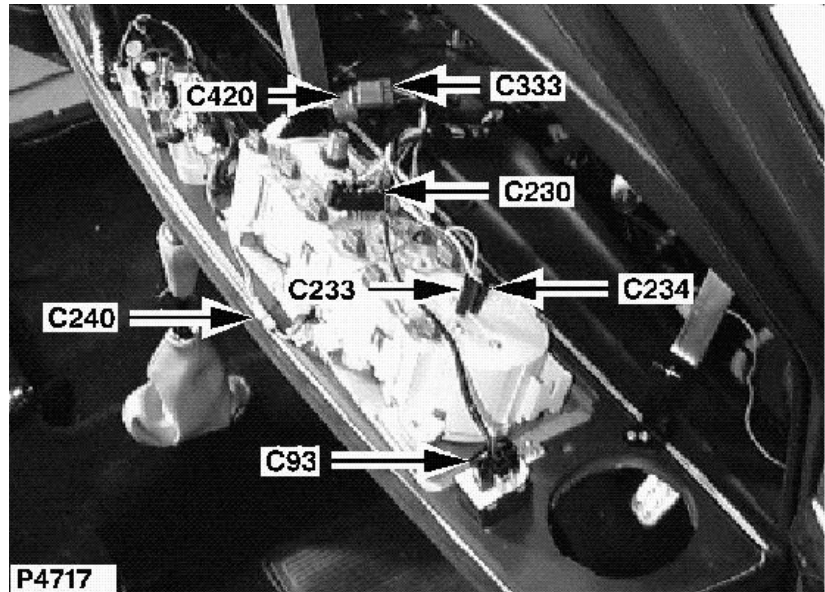

(NL)

Combinatie-instrument  
Vrouwelijk  
ZWART  
Achter rechterkant dashboard

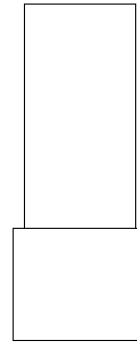

YPS10022

(E)

Grupo de instrumentos  
Hembra  
NEGRO  
Detrás del lado derecho del  
tablero

Cav	Col	Cct
1	WB	ALL

**(GB)**

Instrument pack  
 Female  
 BLACK  
 Behind RH side of fascia

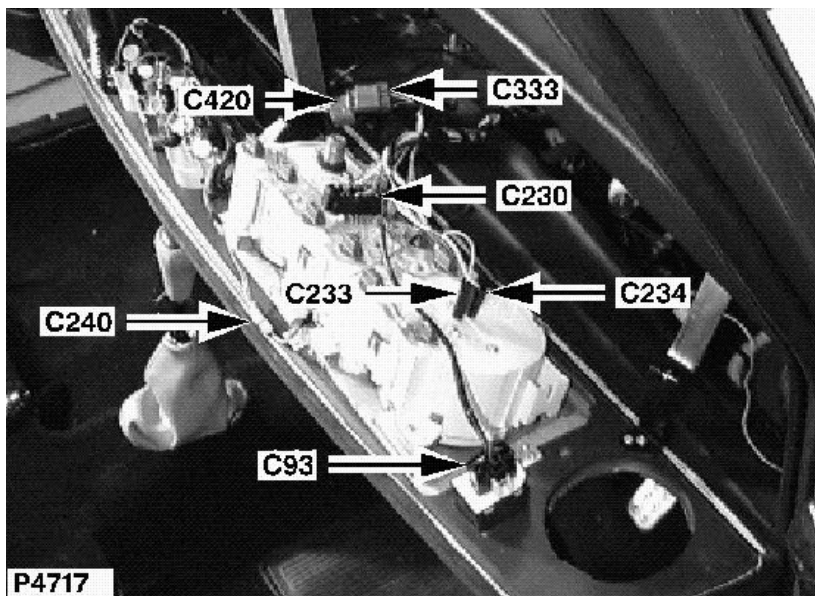

**(NL)**

Combinatie-instrument  
 Vrouwelijk  
 ZWART  
 Achter rechterkant dashboard

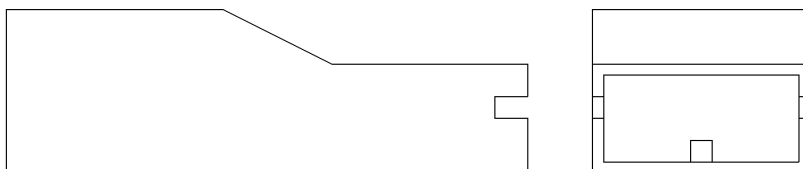

AAU1010

**(E)**

Grupo de instrumentos  
 Hembra  
 NEGRO  
 Detrás del lado derecho del  
 tablero

Cav	Col	Cct
1	W	ALL

# C240

## CONNECTOR / AANSLUITING / CONECTOR

**(GB)**

Alarm led  
Male  
BLACK  
Behind RH side of fascia

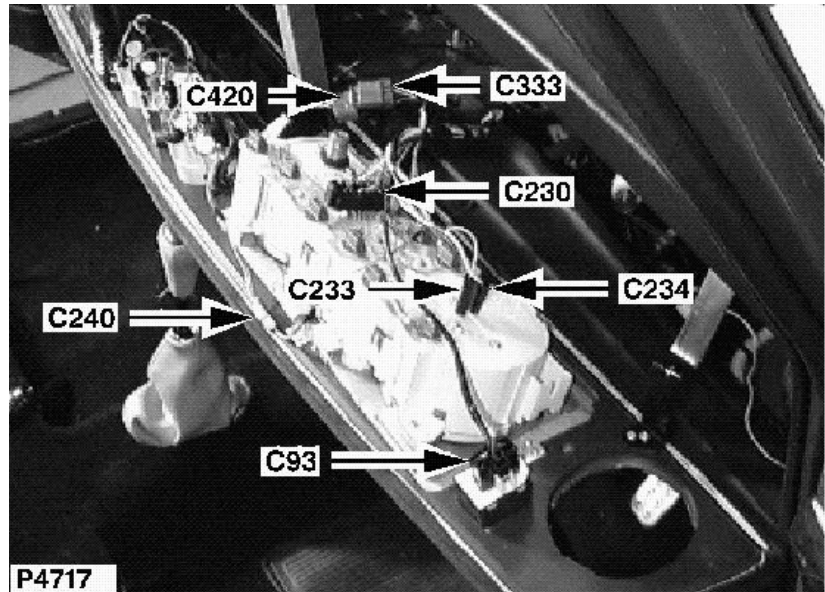

**(NL)**

ALARM LED  
Mannelijk  
ZWART  
Achter rechterkant dashboard

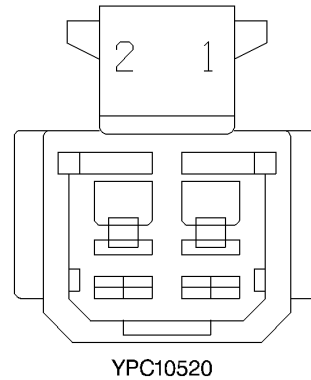

**(E)**

LED DE ALARMA  
Macho  
NEGRO  
Detrás del lado derecho del  
tablero

Cav	Col	Cct
1	YN	ALL
2	PO	ALL

**(GB)**

LH pre-tensioner  
 Female  
 RED  
 Rear of LH rear door jamb

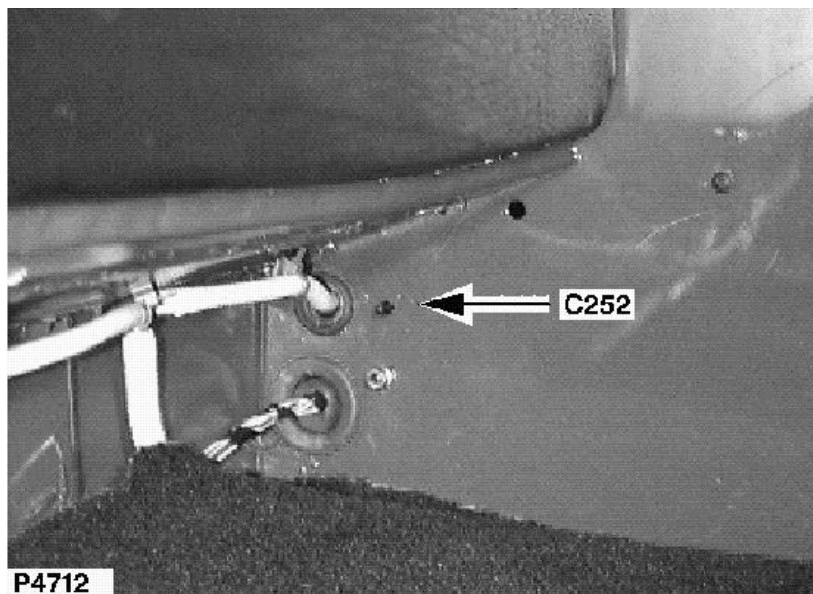
**(NL)**

LINKER  
 AUTOGORDELSPANNER  
 Vrouwelijk  
 ROOD  
 Achter deurstijl linker  
 achterportier

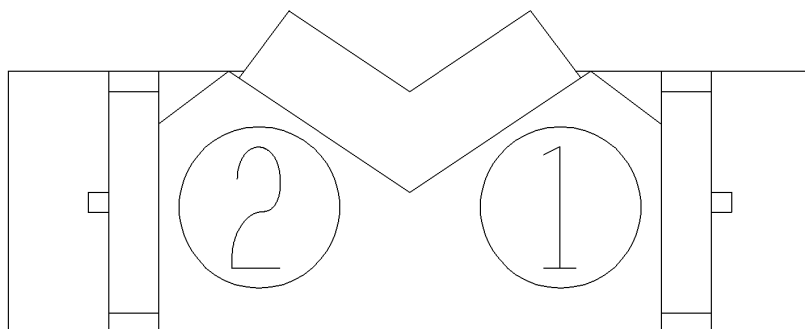

YPC10274

**(E)**

PRETENSOR IZQUIERDO  
 Hembra  
 ROJO  
 Detrás de la jamba de la  
 puerta trasera izquierda

Cav	Col	Cct
1	O	ALL
2	OU	ALL

# C254

## CONNECTOR / AANSLUITING / CONECTOR

(GB)

RH pre-tensioner  
Female  
RED  
Rear of RH rear door jamb

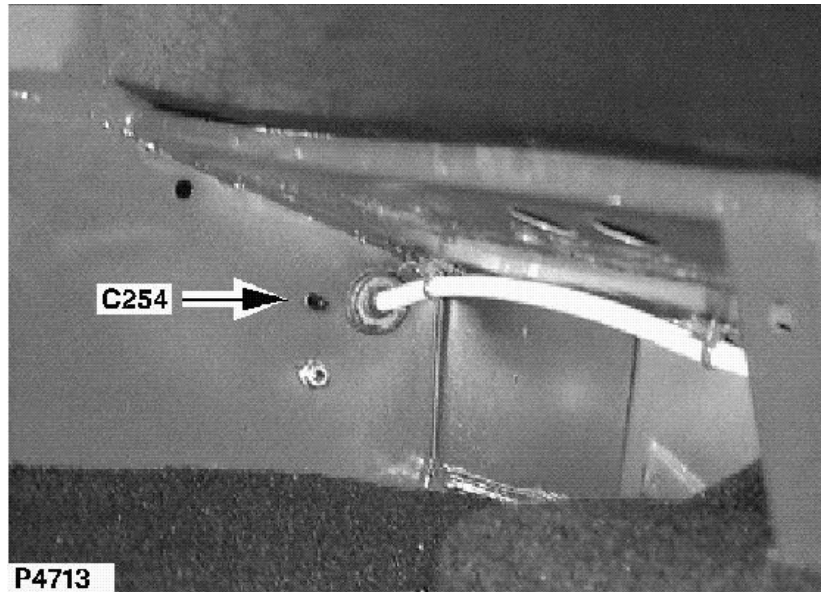

(NL)

RECHTER  
AUTOGORDELSPANNER  
Vrouwelijk  
ROOD  
Achter deurstijl rechter  
achterportier

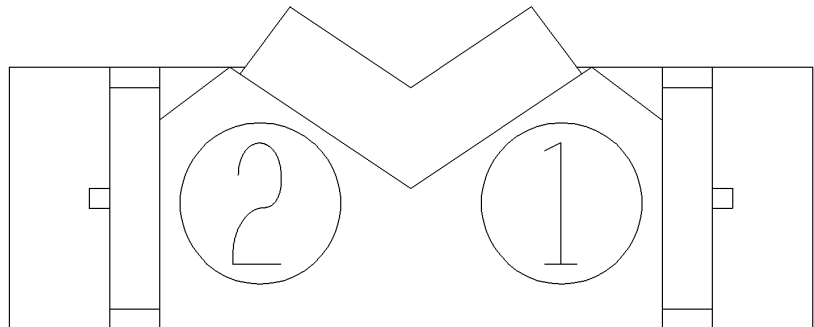

YPC10274

(E)

PRETENSOR DERECHO  
Hembra  
ROJO  
Detrás de la jamba de la  
puerta trasera derecha

Cav	Col	Cct
1	N	ALL
2	NR	ALL

**(GB)**

Airbag control unit  
 Female  
 RED  
 Beneath rear seat

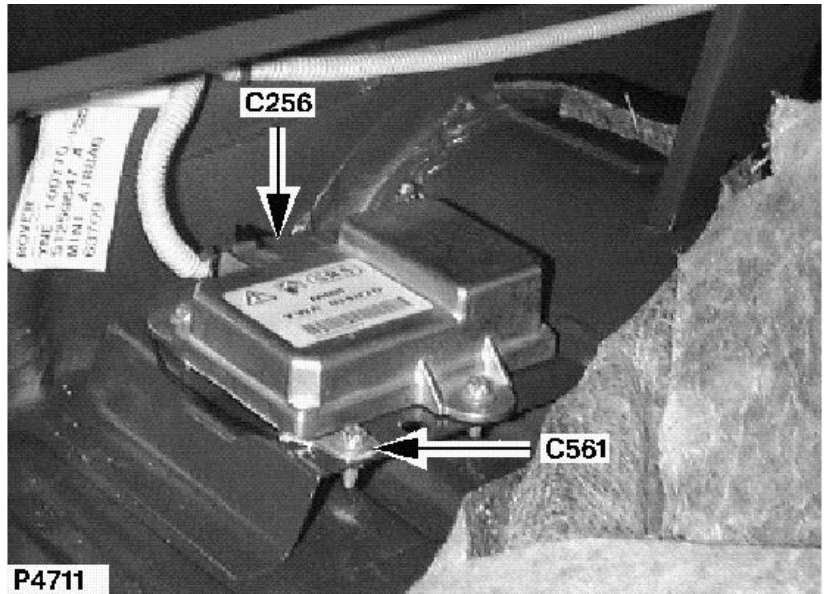

**(NL)**

Airbag - regleenheid  
 Vrouwelijk  
 ROOD  
 Onder achterbank

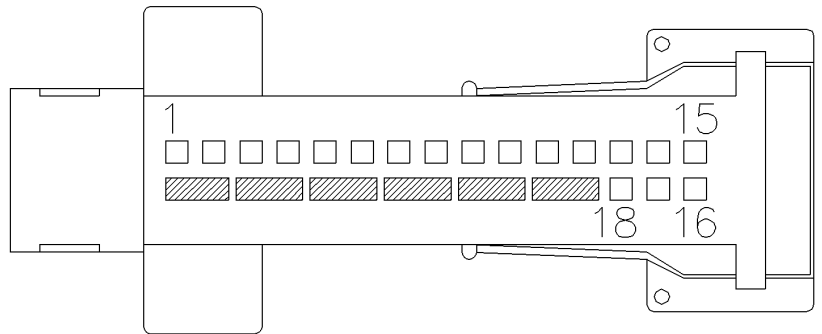

YPC111610

**(E)**

Unidad de control del airbag  
 Hembra  
 ROJO  
 Debajo del asiento trasero

Cav	Col	Cct	Cav	Col	Cct
1	B	ALL	6	NR	ALL
2	P	ALL	11	Y	ALL
3	O	ALL	12	R	ALL
4	OU	ALL	14	YK	ALL
5	N	ALL	15	G	ALL

**(GB)**

RH door switch  
Female  
BLACK  
Behind RH side of fascia

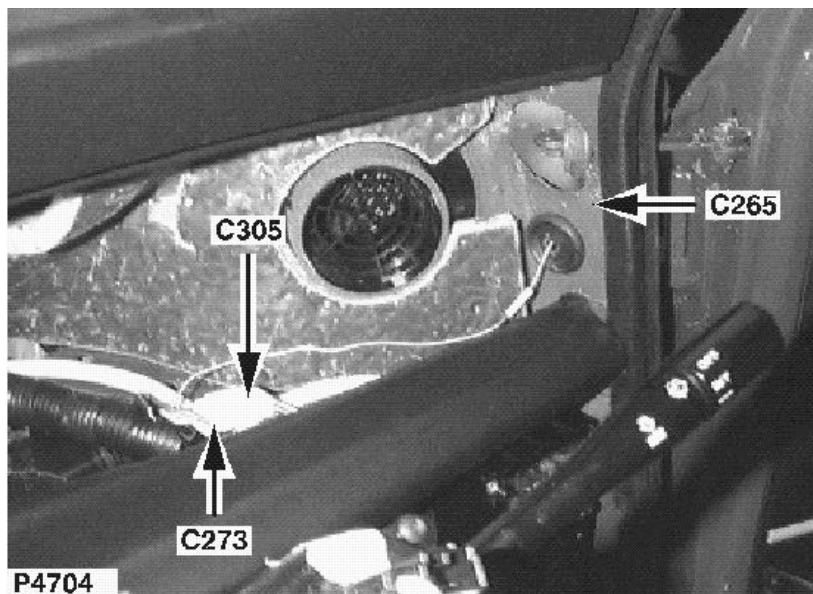

**(NL)**

Rechter portier-schakelaar  
Vrouwelijk  
ZWART  
Achter rechterkant dashboard

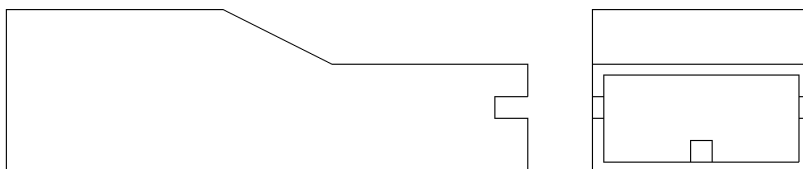

AAU1010

**(E)**

Interruptor de la puerta  
derecha  
Hembra  
NEGRO  
Detrás del lado derecho del  
tablero

Cav	Col	Cct
1	PW	ALL

**(GB)**

LH door switch  
 Female  
 BLACK  
 LH 'A' post

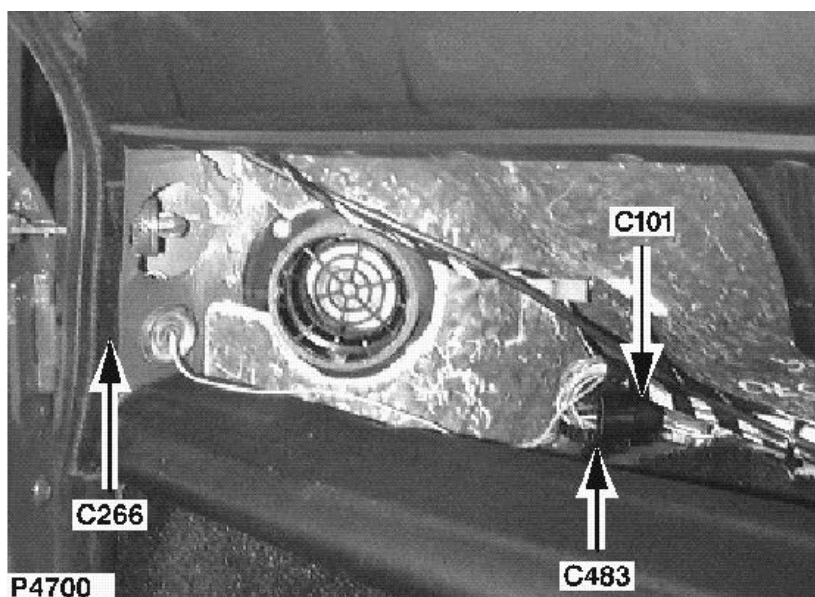
**(NL)**

Linker portier-schakelaar  
 Vrouwelijk  
 ZWART  
 Linker 'A' stijl

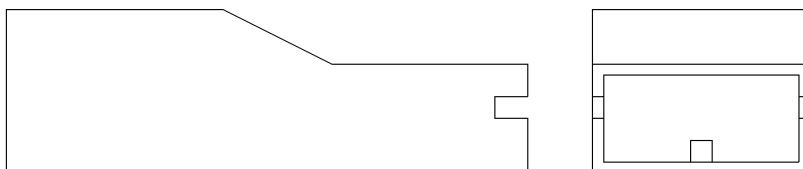

AAU1010

**(E)**

Interruptor de la puerta  
 izquierda  
 Hembra  
 NEGRO  
 Pilar A izquierdo

Cav	Col	Cct
1	PW	ALL



# C273

## CONNECTOR / AANSLUITING / CONECTOR

(GB)

Main Harness to Airbag  
Harness  
Female  
YELLOW  
Behind RH side of fascia

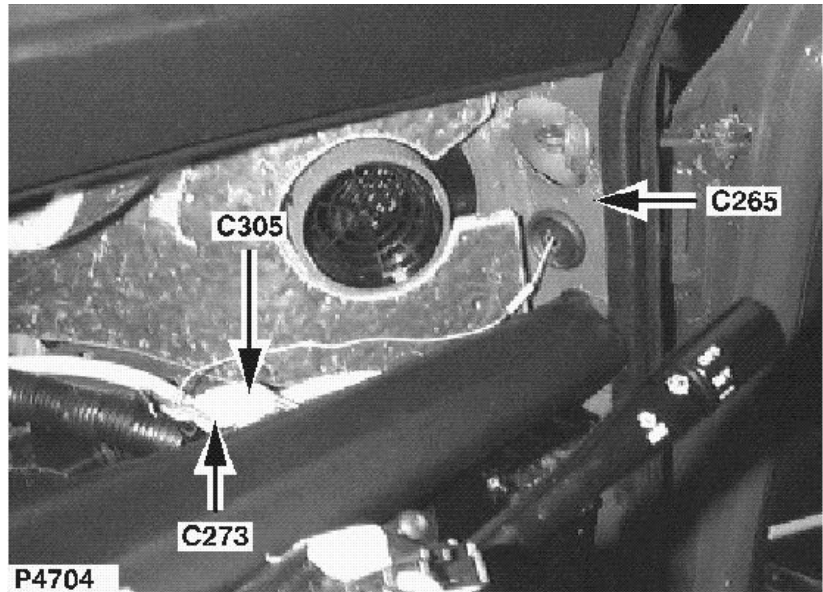

(NL)

Hoofdkabelbundel naar  
airbag-kabelbundel  
Vrouwelijk  
GEEL  
Achter rechterkant dashboard

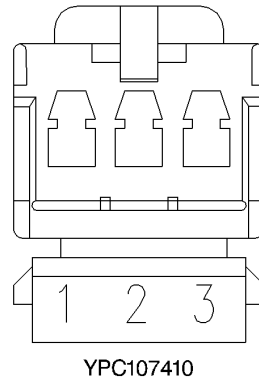

(E)

Mazo de cables principal al  
mazo de cables del airbag  
Hembra  
AMARILLO  
Detrás del lado derecho del  
tablero

Cav	Col	Cct
1	G	ALL
2	P	ALL
3	YK	ALL

**(GB)**

RH driving lamp  
 Female  
 BLUE  
 Behind the front grille

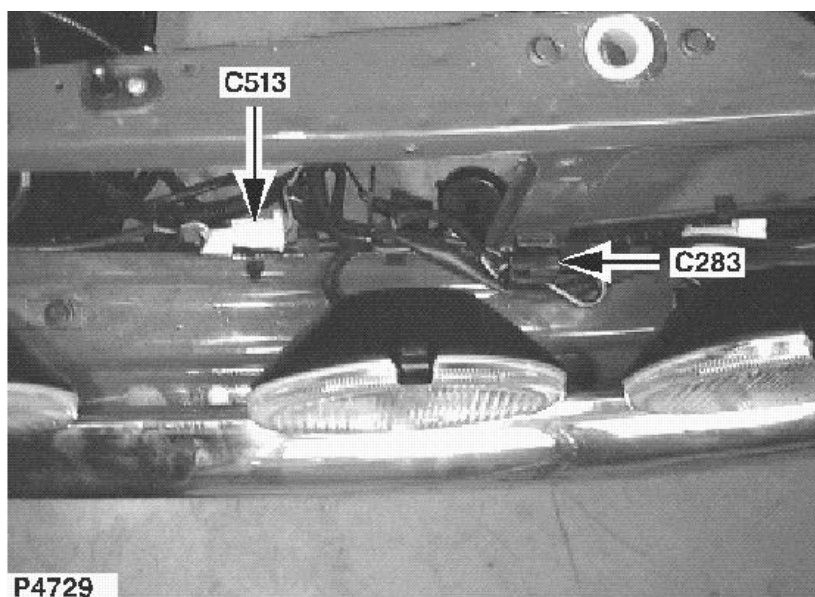
**(NL)**

Rechter rijlamp  
 Vrouwelijk  
 BLAUW  
 Achter voor-grille

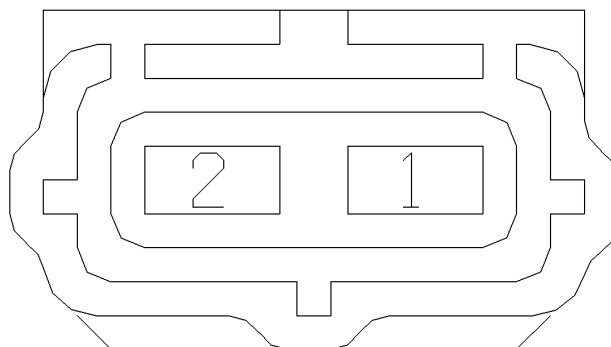

YPC10208

**(E)**

Faro antiniebla derecho  
 Hembra  
 AZUL  
 Detrás de la rejilla delantera

Cav	Col	Cct
1	UY	ALL
2	B	ALL

**(GB)**

LH driving lamp  
 Female  
 BLUE  
 Behind the front grille

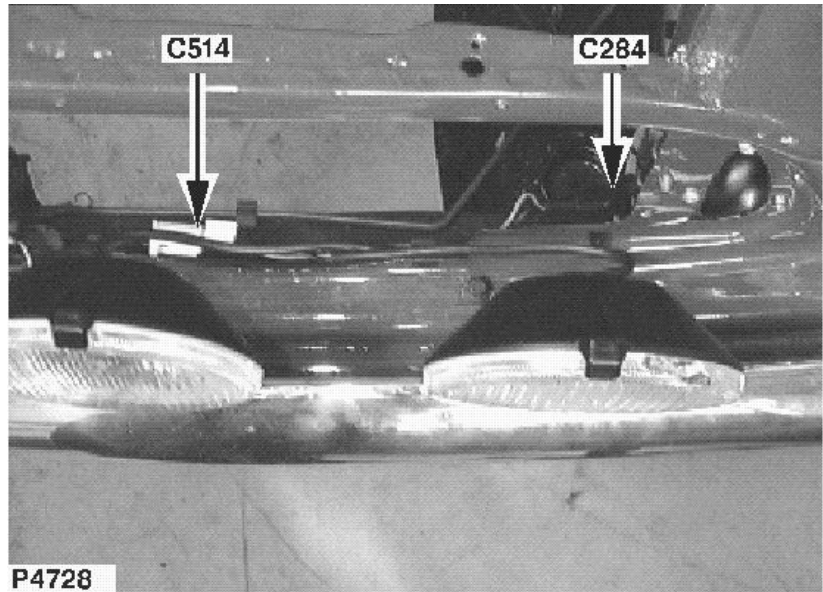

**(NL)**

Linker rijlamp  
 Vrouwelijk  
 BLAUW  
 Achter voor-grille

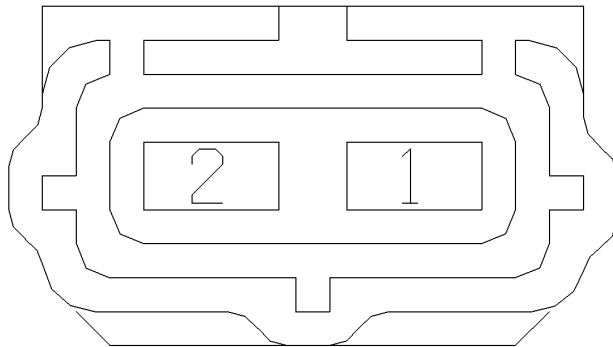

YPC10208

**(E)**

Faro antiniebla izquierdo  
 Hembra  
 AZUL  
 Detrás de la rejilla delantera

Cav	Col	Cct
1	UY	ALL
2	B	ALL

**(GB)**

Brake test switch  
 Female  
 NATURAL  
 Behind centre of fascia

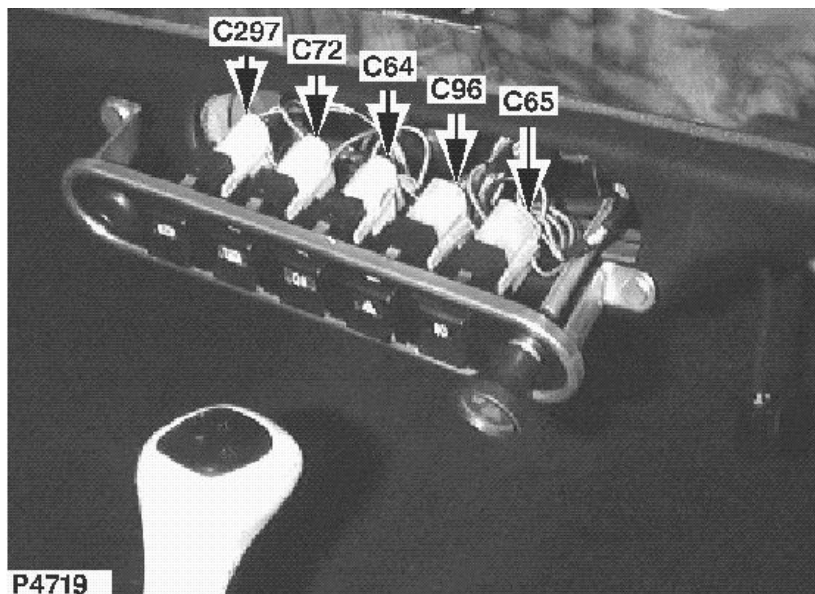
**(NL)**

Remtest-schakelaar  
 Vrouwelijk  
 NATUREL  
 achter middelste gedeelte  
 dashboard

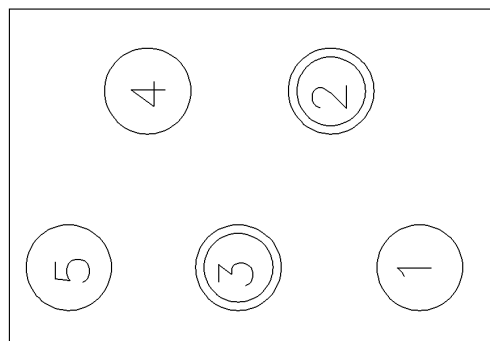

13H9745

**(E)**

Interruptor de prueba de  
 frenos  
 Hembra  
 NATURAL  
 detrás de la parte central del  
 tablero

Cav	Col	Cct
2	BW	ALL
3	B	ALL

# C305

## CONNECTOR / AANSLUITING / CONECTOR

(GB)

Airbag Harness to Main  
Harness  
Male  
YELLOW  
Behind RH side of fascia

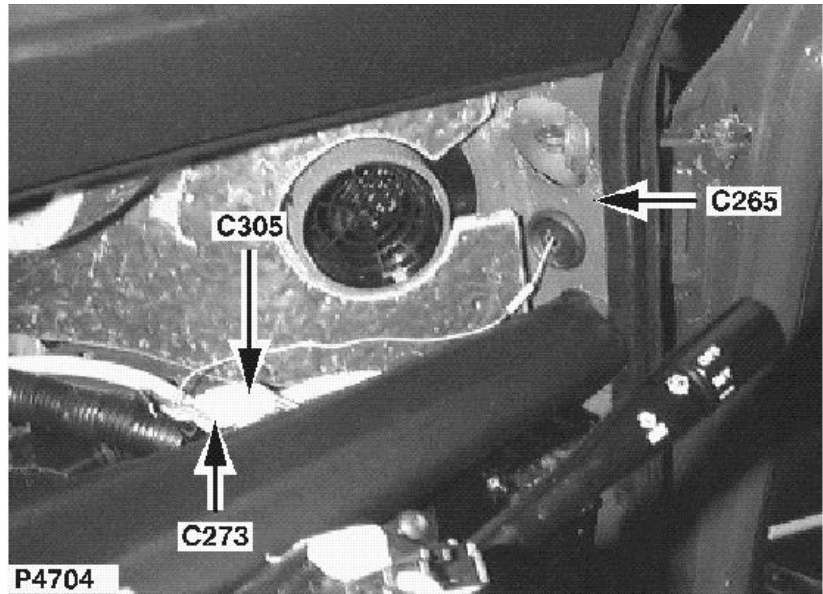

(NL)

Airbag-kabelbundel naar  
hoofdkabelbundel  
Mannelijk  
GEEL  
Achter rechterkant dashboard

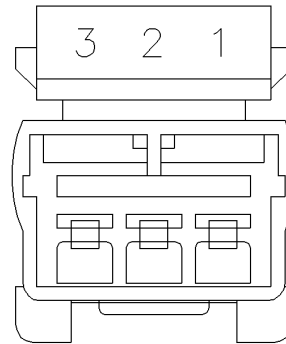

YPC110080

(E)

Mazo de cables del airbag al  
mazo de cables principal  
Macho  
AMARILLO  
Detrás del lado derecho del  
tablero

Cav	Col	Cct
1	G	ALL
2	P	ALL
3	YK	ALL

**(GB)**

RH rear speaker

Female

BLACK

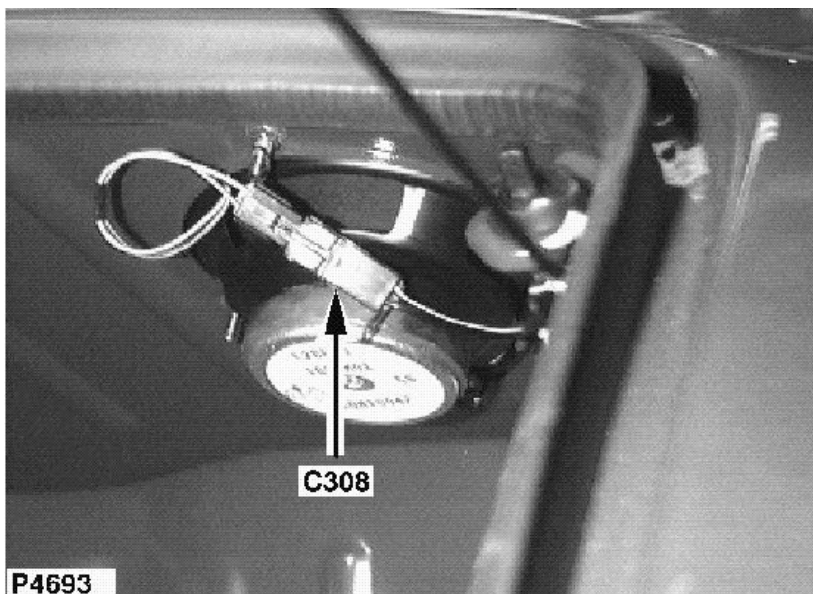
Inside luggage compartment,  
below RH parcel tray support**(NL)**

Rechter achterste luidspreker

Vrouwelijk

ZWART

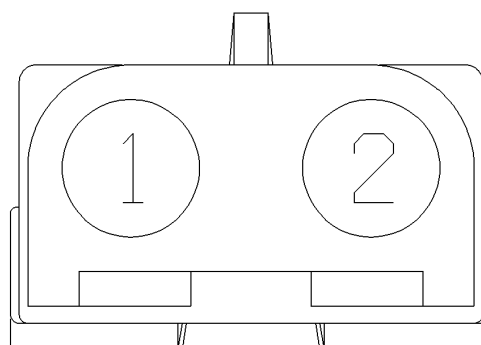
In bagageruimte, onder  
rechter steun van pakjesplank

AFU4460

**(E)**

Altavoz trasero derecho

Hembra

NEGRO

Interior del maletero, debajo  
del soporte derecho de la  
bandeja trasera

Cav	Col	Cct
1	SB	ALL
2	SK	ALL

# C310

## CONNECTOR / AANSLUITING / CONECTOR

**(GB)**

LH rear speaker  
Female  
BLACK  
Luggage compartment - LH  
side

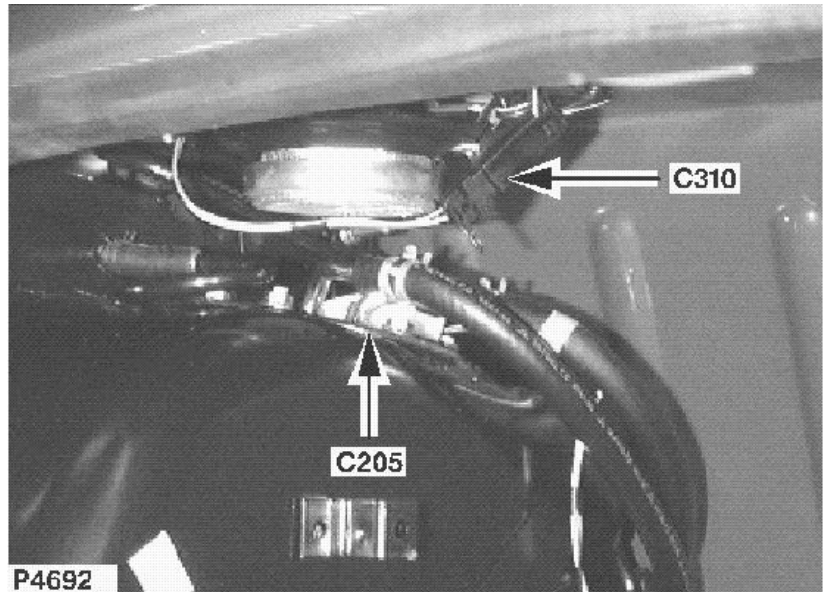

**(NL)**

Linker achterste luidspreker  
Vrouwelijk  
ZWART  
bagageruimte - Links

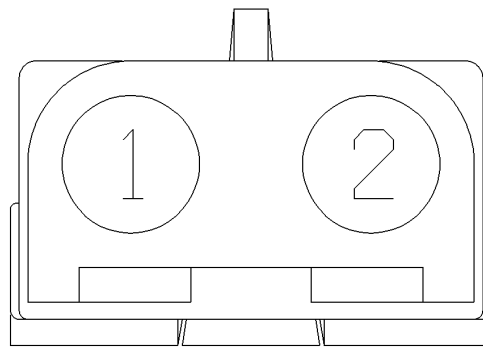

AFU4460

**(E)**

Altavoz trasero izquierdo  
Hembra  
NEGRO  
maletero - Lado izquierdo

Cav	Col	Cct
1	UB	ALL
2	UK	ALL

**(GB)**

Main Harness to Instrument  
Link Harness  
Female  
BLACK  
Behind RH side of fascia

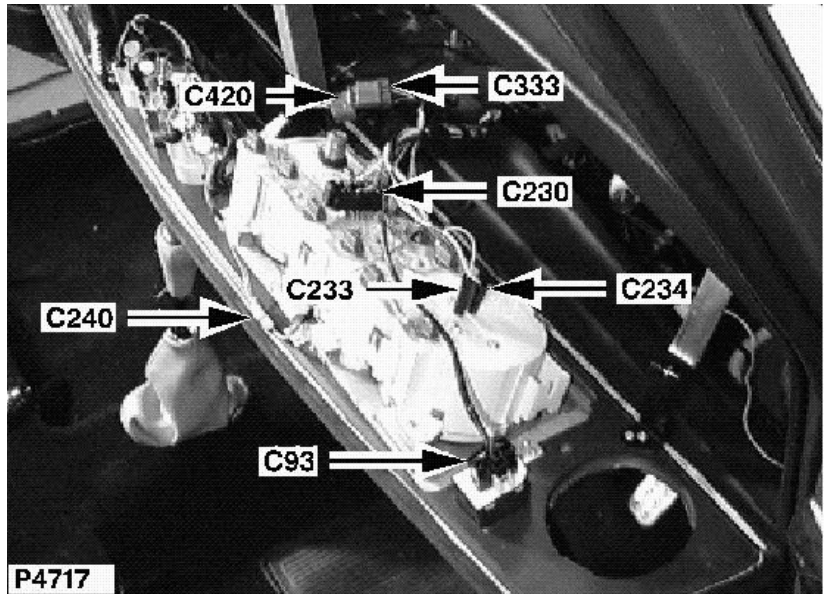

**(NL)**

Hoofdkabelbundel naar  
verbindingskabelbundel voor  
instrumenten  
Vrouwelijk  
ZWART  
Achter rechterkant dashboard

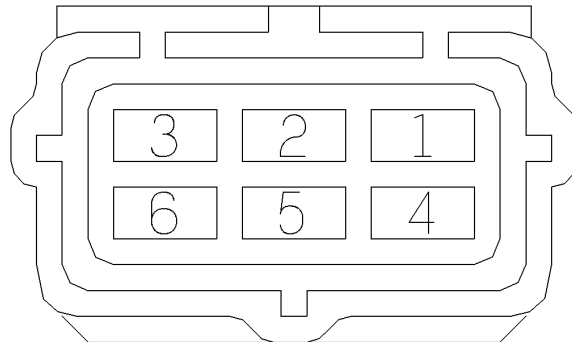

YPC10063

**(E)**

Mazo de cables principal al  
mazo de cables de  
instrumentos  
Hembra  
NEGRO  
Detrás del lado derecho del  
tablero

Cav	Col	Cct
1	NU	ALL
2	PO	ALL
3	W	ALL
4	RW	ALL
5	B	ALL



# C334

## CONNECTOR / AANSLUITING / CONECTOR

(GB)

Oil temperature gauge  
Male  
BLACK  
Behind centre of fascia

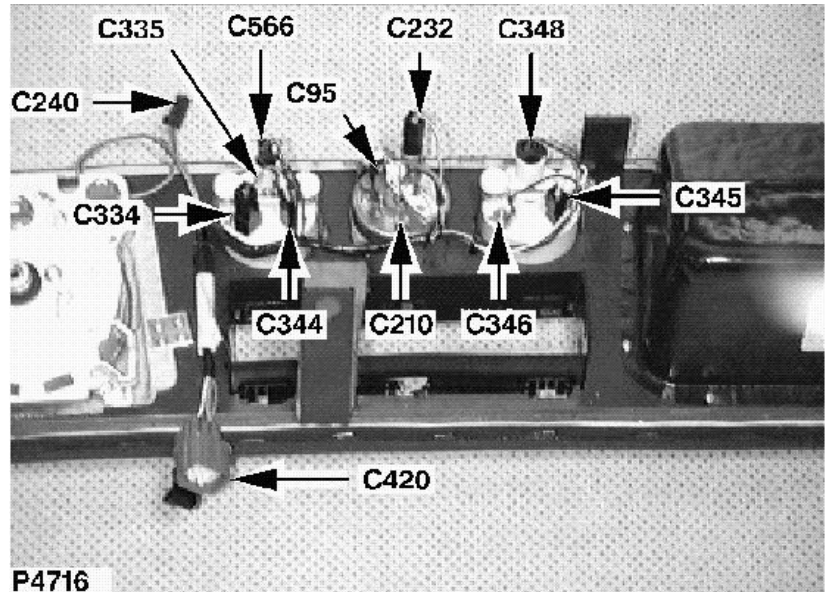

(NL)

OLIETEMPERATUURMETE  
R  
Mannelijk  
ZWART  
achter middelste gedeelte  
dashboard

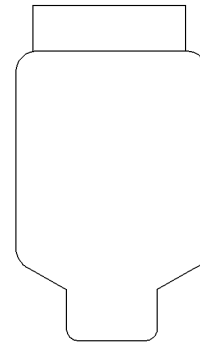

ULC1376

(E)

INDICADOR DE  
TEMPERATURA DEL  
ACEITE  
Macho  
NEGRO  
detrás de la parte central del  
tablero

Cav	Col	Cct
1	NU	ALL

**(GB)**

Oil temperature gauge  
Female  
PHOS-BRON  
Behind centre of fascia

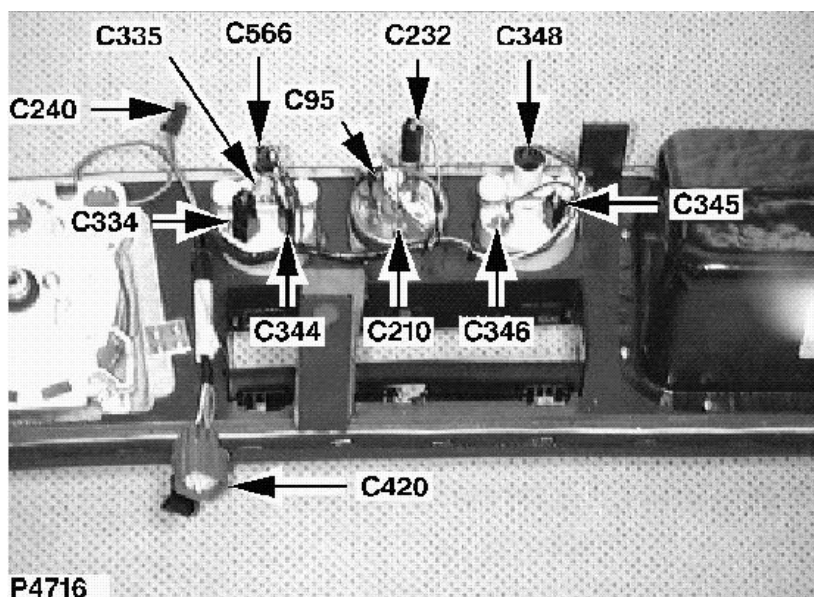
**(NL)**

OLIETEMPERATUURMETE  
R  
Vrouwelijk  
FOSFORBRONS  
achter middelste gedeelte  
dashboard

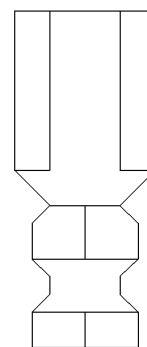

ADU9185

**(E)**

INDICADOR DE  
TEMPERATURA DEL  
ACEITE  
Hembra  
BRONCE FOSFOROSO  
detrás de la parte central del  
tablero

Cav	Col	Cct
1	B	ALL

# C344

## CONNECTOR / AANSLUITING / CONECTOR

(GB)

Oil temperature gauge  
Female  
BLACK  
Behind centre of fascia

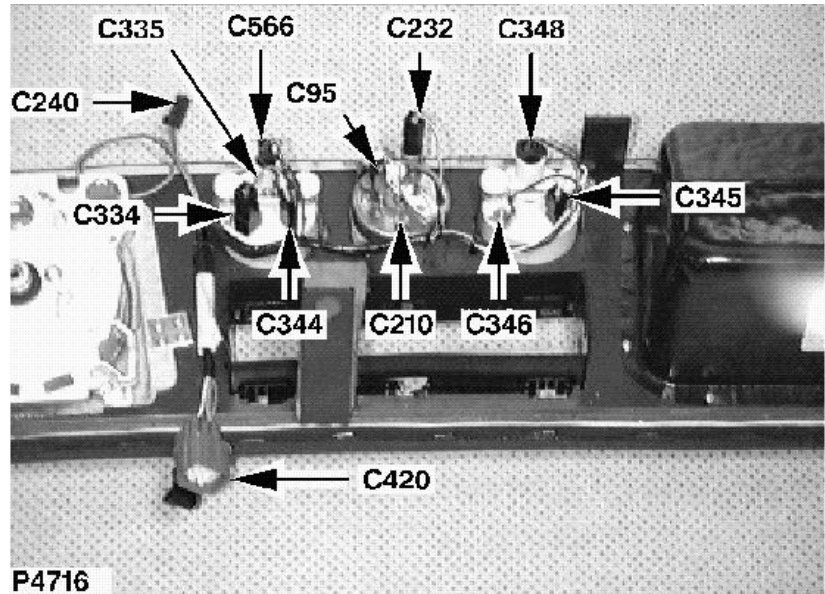

(NL)

OLIETEMPERATUURMETE  
R  
Vrouwelijk  
ZWART  
achter middelste gedeelte  
dashboard

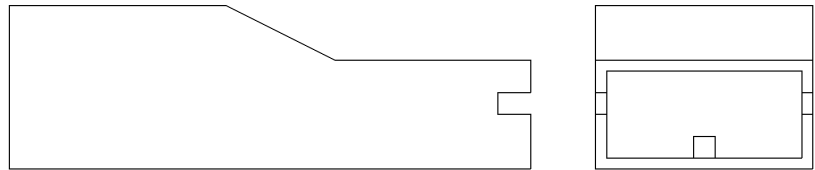

AAU1010

(E)

INDICADOR DE  
TEMPERATURA DEL  
ACEITE  
Hembra  
NEGRO  
detrás de la parte central del  
tablero

Cav	Col	Cct
1	W	ALL

**(GB)**

Voltage gauge  
Female  
BLACK  
Behind centre of fascia

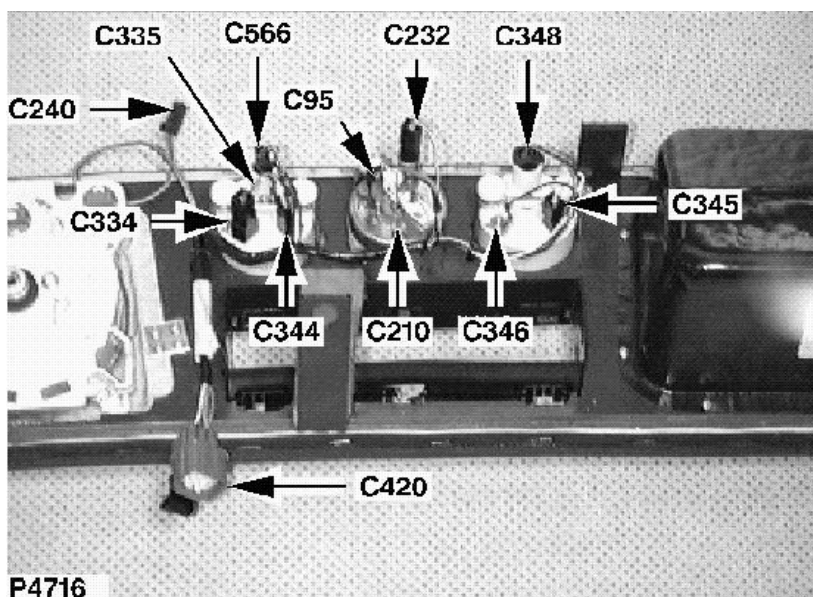
**(NL)**

Spanningsmeter  
Vrouwelijk  
ZWART  
achter middelste gedeelte  
dashboard

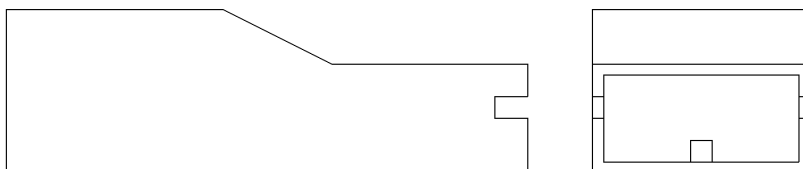

AAU1010

**(E)**

Indicador de tensión  
Hembra  
NEGRO  
detrás de la parte central del  
tablero

Cav	Col	Cct
1	W	ALL

# C346

## CONNECTOR / AANSLUITING / CONECTOR

(GB)

Voltage gauge  
Female  
PHOS-BRON  
Behind centre of fascia

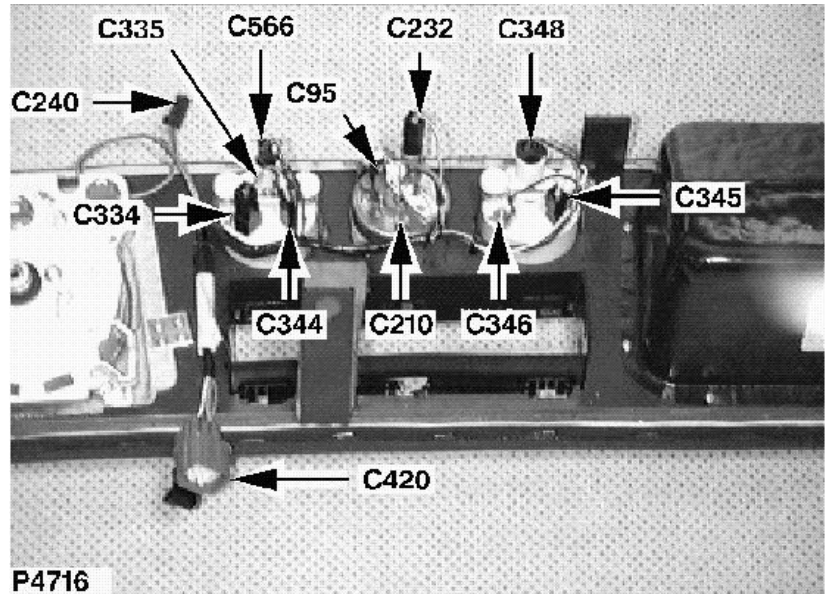

(NL)

Spanningsmeter  
Vrouwelijk  
FOSFORBRONS  
achter middelste gedeelte  
dashboard

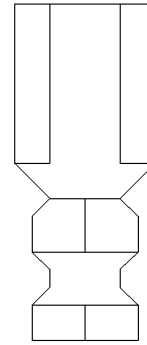

ADU9185

(E)

Indicador de tensión  
Hembra  
BRONCE FOSFOROSO  
detrás de la parte central del  
tablero

Cav	Col	Cct
1	B	ALL

**(GB)**

Voltage gauge  
 Female  
 BLACK  
 Behind centre of fascia

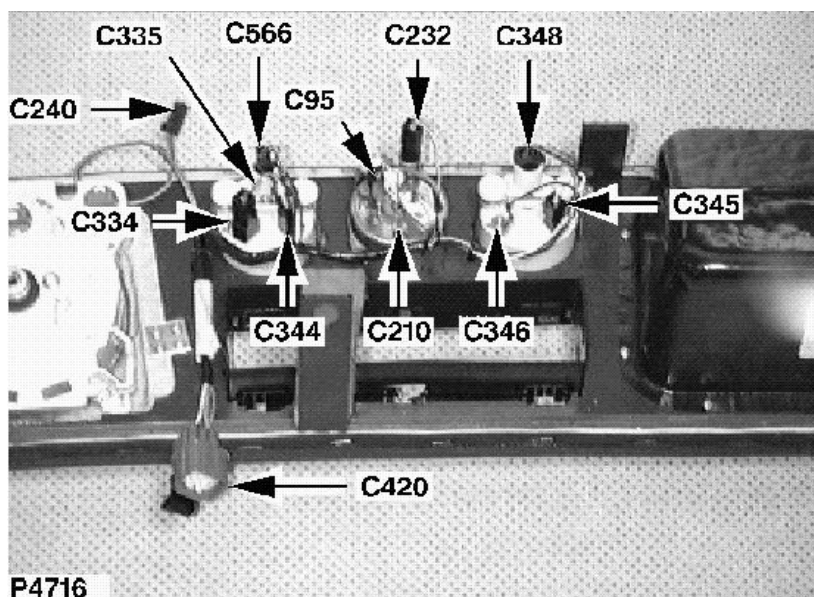
**(NL)**

Spanningsmeter  
 Vrouwelijk  
 ZWART  
 achter middelste gedeelte  
 dashboard

**(E)**

Indicador de tensión  
 Hembra  
 NEGRO  
 detrás de la parte central del  
 tablero

Cav	Col	Cct
1	RW	ALL
2	B	ALL

# C355

## CONNECTOR / AANSLUITING / CONECTOR

**(GB)**

Interior lamp unit  
Female  
BLACK  
Behind ultrasonic sensor

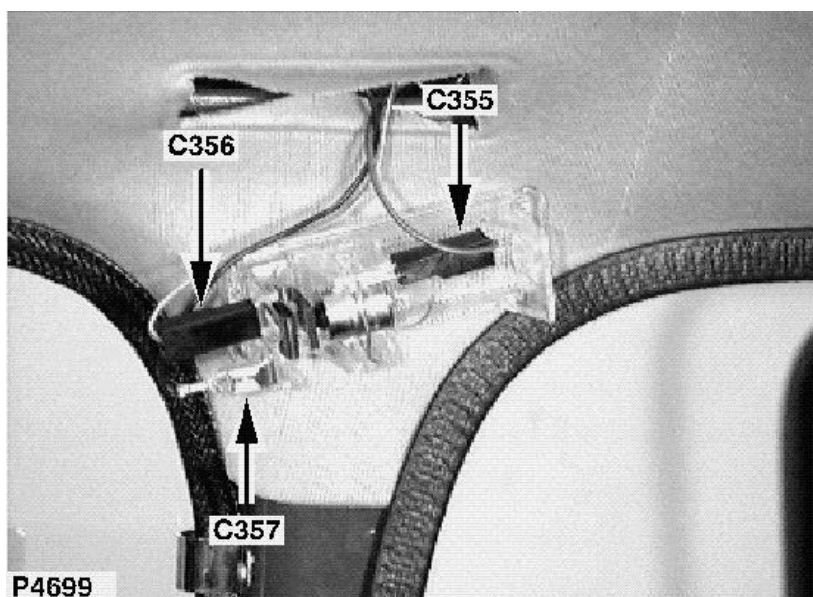

**(NL)**

Interieurverlichting -  
lampeenheid  
Vrouwelijk  
ZWART  
Achter ultrasonische sensor

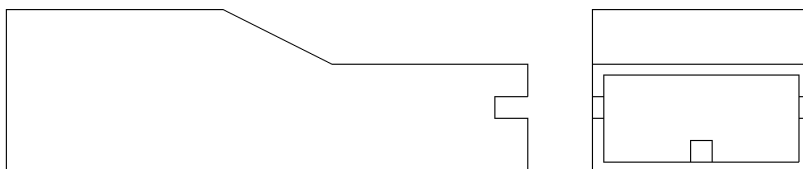

AAU1010

**(E)**

Unidad de luces interiores  
Hembra  
NEGRO  
Detrás del sensor ultrasónico

Cav	Col	Cct
1	PO	ALL

**(GB)**

Interior lamp unit  
 Female  
 BLACK  
 Behind ultrasonic sensor

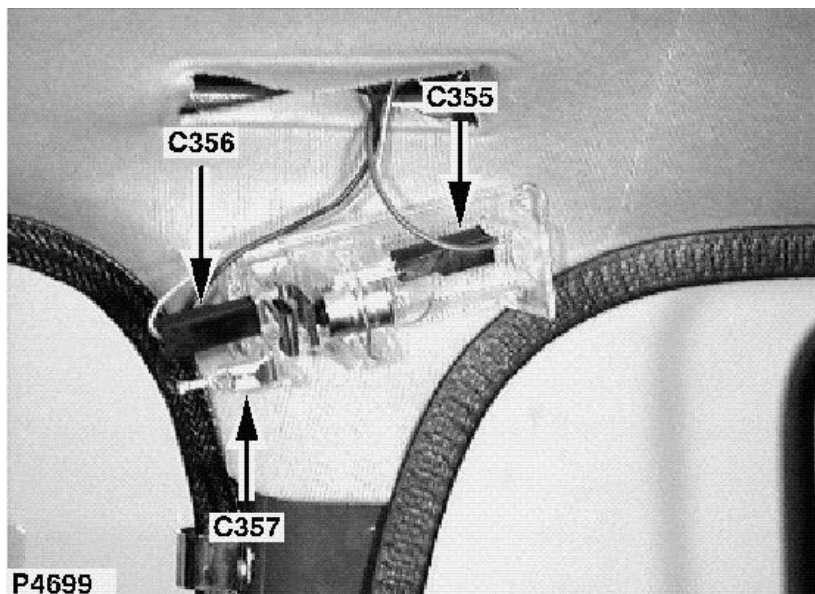
**(NL)**

Interieurverlichting -  
 lampeenheid  
 Vrouwelijk  
 ZWART  
 Achter ultrasonische sensor

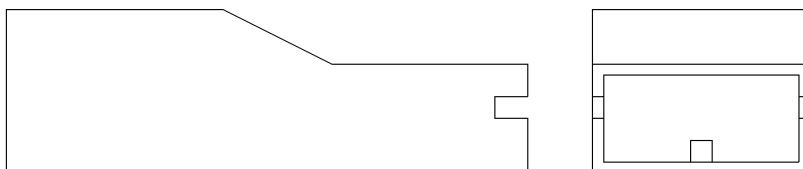

AAU1010

**(E)**

Unidad de luces interiores  
 Hembra  
 NEGRO  
 Detrás del sensor ultrasónico

Cav	Col	Cct
1	PW	ALL



**(GB)**

Interior lamp unit  
Female  
BRASS, TIN-PLATED  
Behind ultrasonic sensor

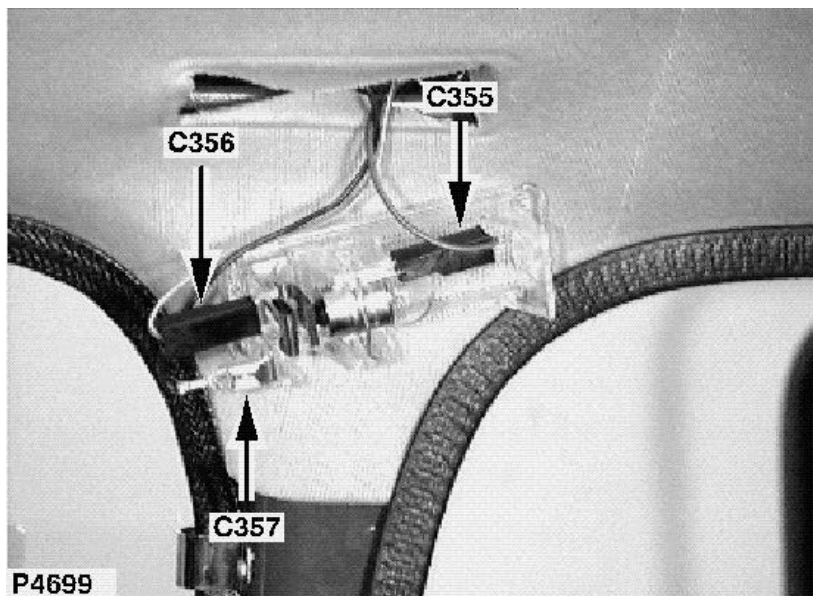

**(NL)**

Interieurverlichting -  
lampeenheid  
Vrouwelijk  
KOPER  
Achter ultrasonische sensor

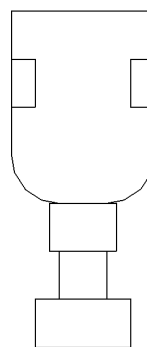

ADU9566

**(E)**

Unidad de luces interiores  
Hembra  
LATON  
Detrás del sensor ultrasónico

Cav	Col	Cct
1	B	ALL

**(GB)**

Radio earth  
Eyelet  
TIN-PLATE  
Behind centre of fascia

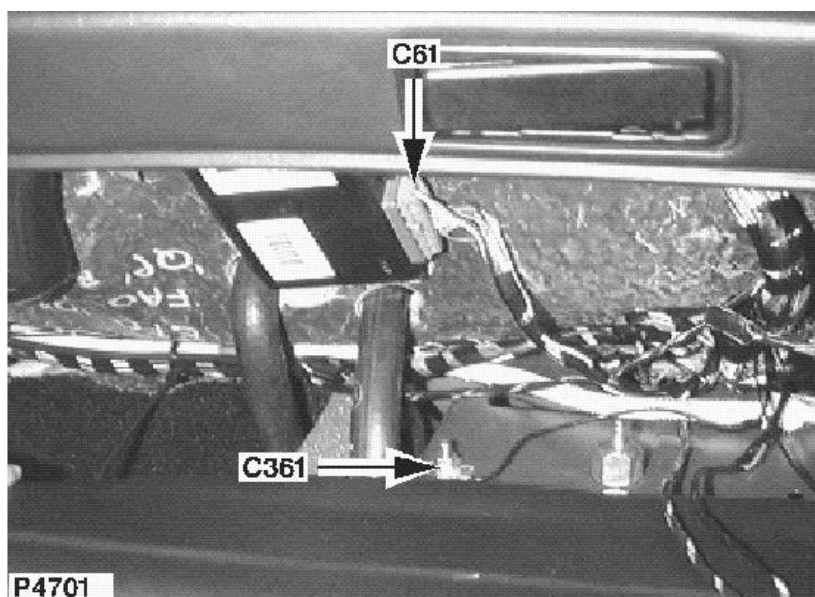
**(NL)**

Radio - massa  
Oogje  
VERTIND  
achter middelste gedeelte  
dashboard

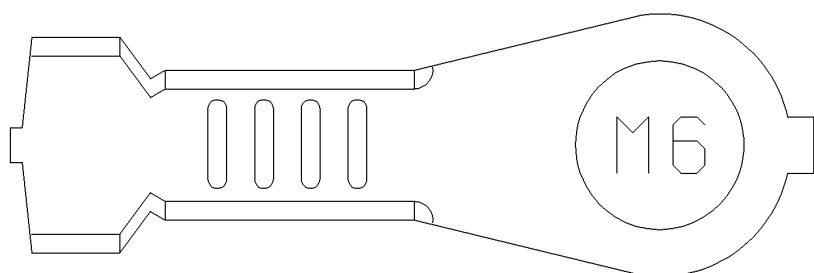

YPG10003

**(E)**

Masa de radio  
Ollao  
PLACA ESTAÑO  
detrás de la parte central del  
tablero

Cav	Col	Cct
1	B	ALL

**(GB)**

Heated rear window element  
Female  
BLACK  
LH rear quarter trim panel

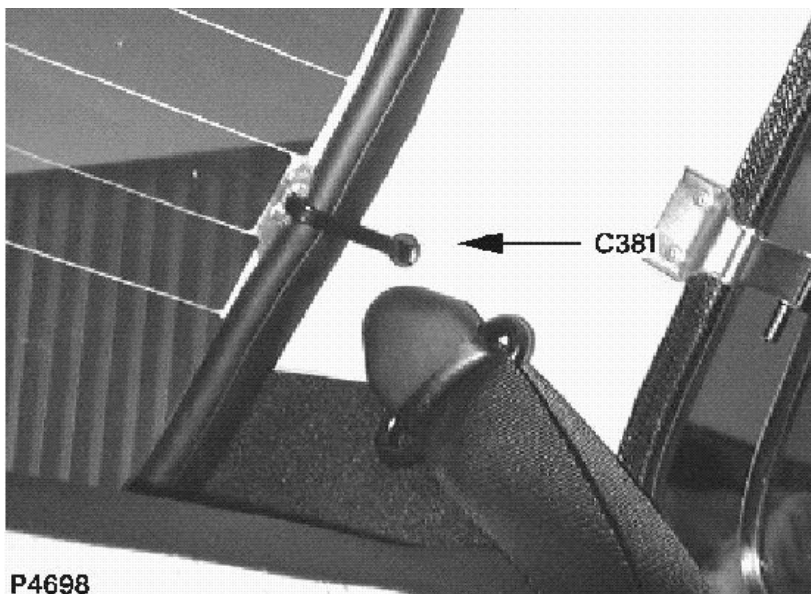

**(NL)**

Verwarmde achterraut -  
verwarmingselement  
Vrouwelijk  
ZWART  
Linker achterste kwart-  
bekledingspaneel

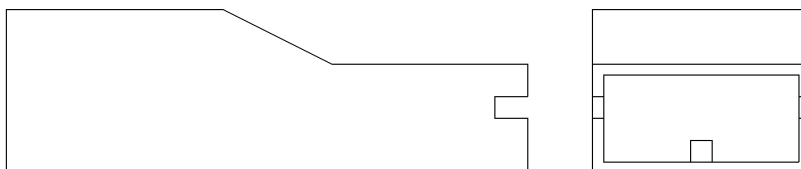

AAU1010

**(E)**

Elemento de luneta térmica  
Hembra  
NEGRO  
Guarnecido lateral trasero  
izquierdo

Cav	Col	Cct
1	GY	ALL

**(GB)**

Instrument Link Harness to  
Main Harness  
Male  
BLACK  
Behind RH side of fascia

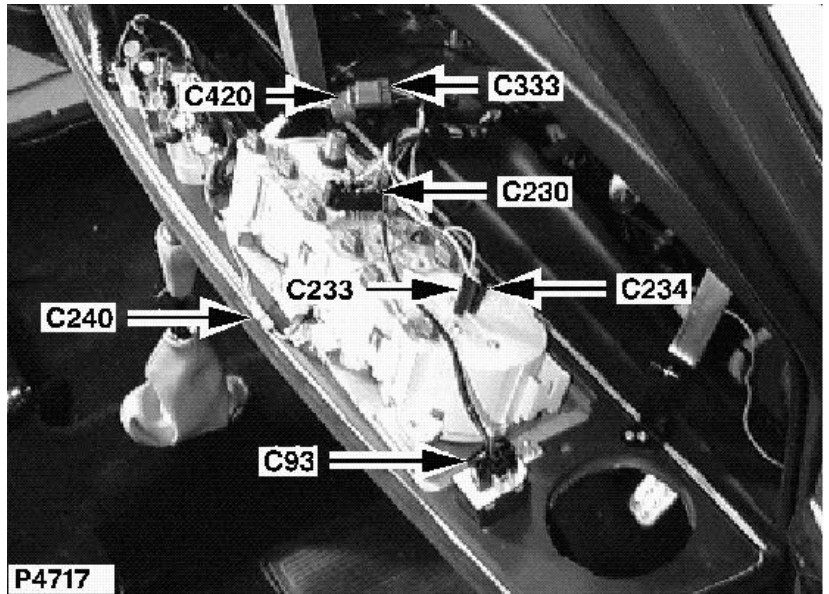

**(NL)**

Verbindingskabelbundel voor  
instrumenten naar  
hoofdkabelbundel  
Mannelijk  
ZWART  
Achter rechterkant dashboard

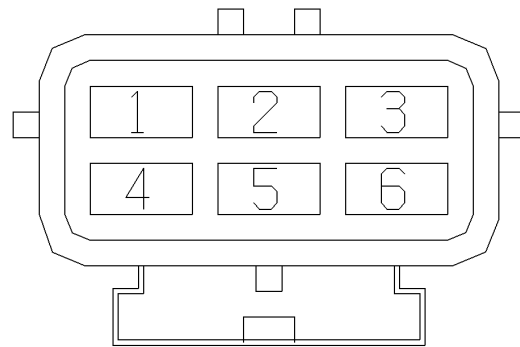

YPC10057

**(E)**

Mazo de cables de enlace de  
instrumentos al mazo de  
cables principal  
Macho  
NEGRO  
Detrás del lado derecho del  
tablero

Cav	Col	Cct
1	NU	ALL
2	PO	ALL
3	W	ALL
4	RW	ALL
5	B	ALL

# C427

## CONNECTOR / AANSLUITING / CONECTOR

**(GB)**

Main Harness to Fog Lamp  
Harness  
Female  
BLACK  
Top of bulkhead - centre

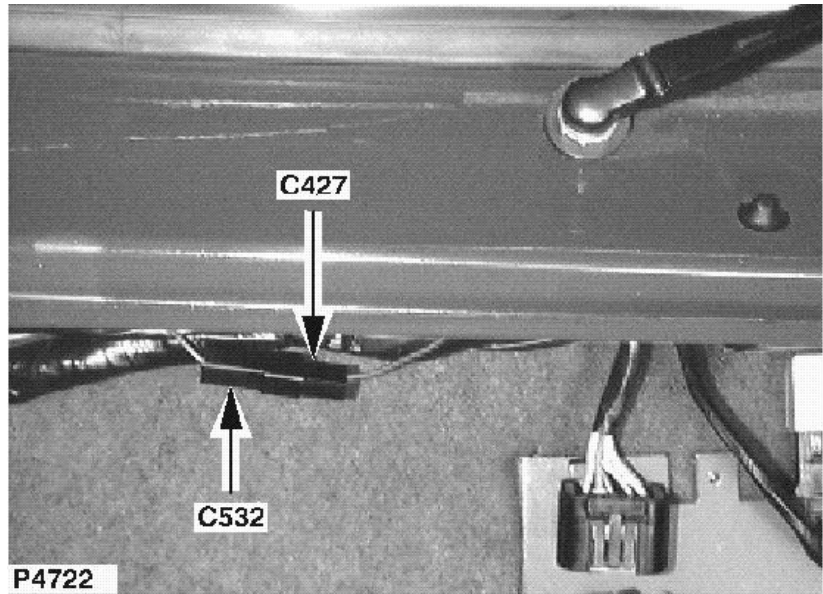

**(NL)**

Hoofdkabelbundel naar  
kabelbundel voor mistlampen  
Vrouwelijk  
ZWART  
Bovenkant schutbord -  
midden

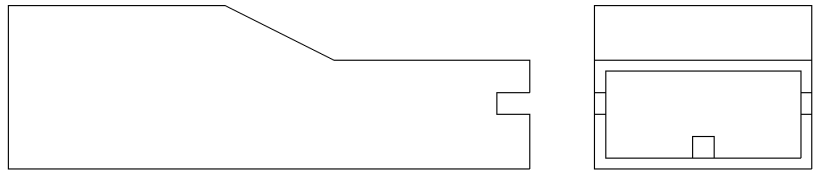

AAU1010

**(E)**

Mazo de cables principal al  
mazo de cables de luces  
antiniebla  
Hembra  
NEGRO  
Parte superior del salpicadero  
- centro

Cav	Col	Cct
1	RB	ALL

**(GB)**

Main Harness to Engine  
 Harness  
 Female  
 BLACK  
 LH side of bulkhead

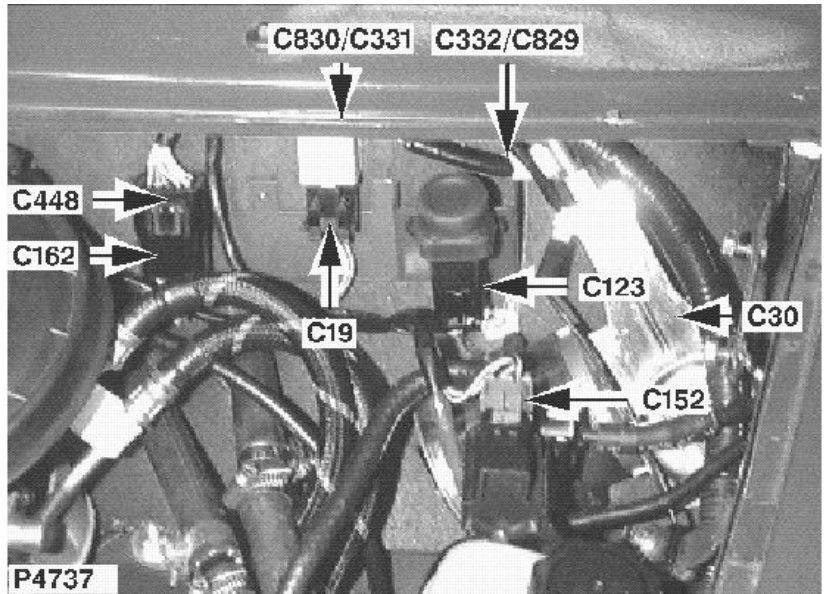

**(NL)**

Hoofdkabelbundel naar  
 motor-kabelbundel  
 Vrouwelijk  
 ZWART  
 Linkerkant tussenschot

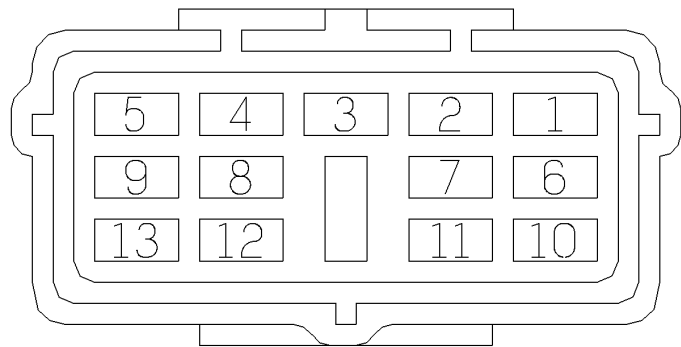

YPC10062

**(E)**

Mazo de cables principal al  
 mazo de cables motor  
 Hembra  
 NEGRO  
 Lado izquierdo del  
 salpicadero

Cav	Col	Cct	Cav	Col	Cct
1	W	ALL	7	NY	ALL
2	WR	ALL	8	WN	ALL
3	GU	ALL	9	LGB	ALL
4	NS	ALL	10	WR	ALL
5	WS	ALL	11	WY	ALL
6	WB	ALL	12	NU	ALL

# C475

## CONNECTOR / AANSLUITING / CONECTOR

**(GB)**

Rear fog lamp  
Male  
BLACK  
Luggage compartment - LH  
side

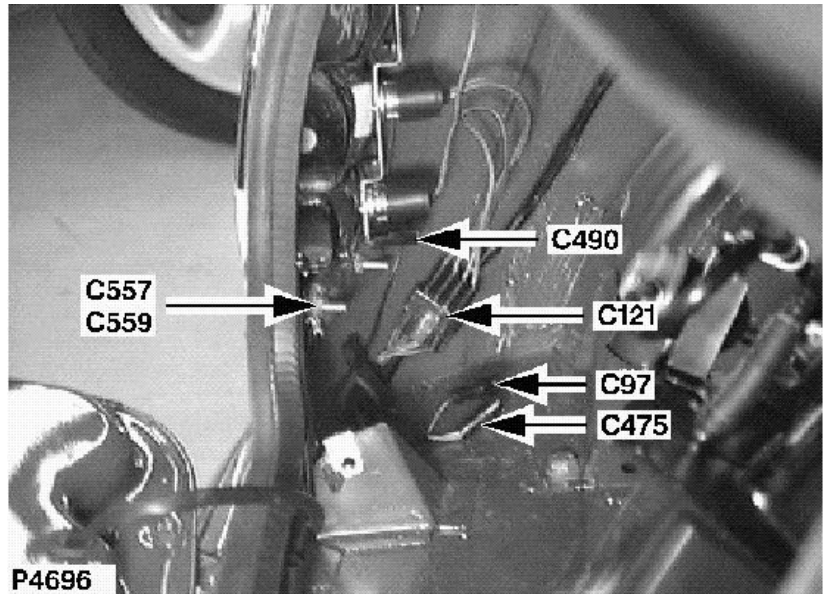

**(NL)**

Mistachterlamp  
Mannelijk  
ZWART  
bagageruimte - Links

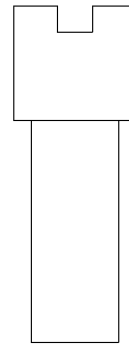

ADU2150

**(E)**

Piloto antiniebla trasero  
Macho  
NEGRO  
maletero - Lado izquierdo

Cav	Col	Cct
1	UY	ALL

**(GB)**

Main Harness to Body  
 Harness  
 Female  
 BLACK  
 LH 'A' post

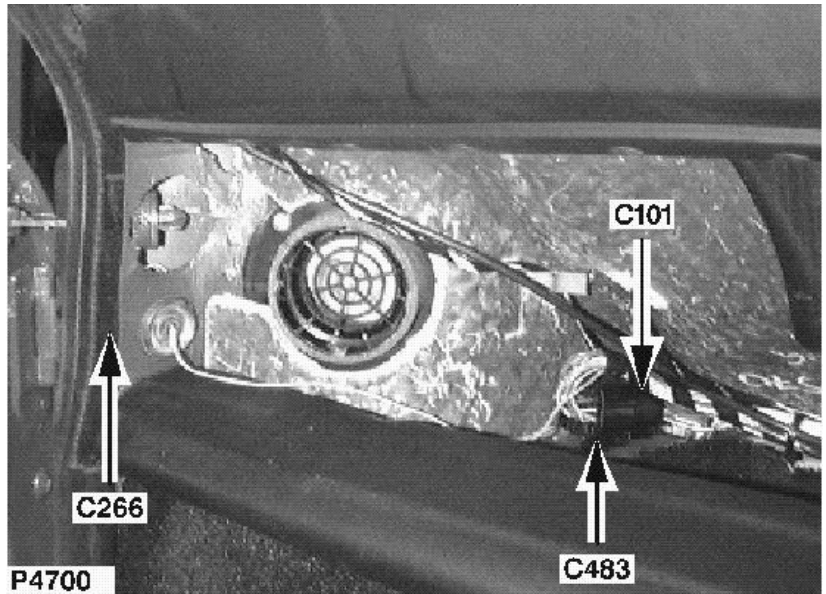

**(NL)**

Hoofdkabelbundel naar  
 carrosserie-kabelbundel  
 Vrouwelijk  
 ZWART  
 Linker 'A' stijl

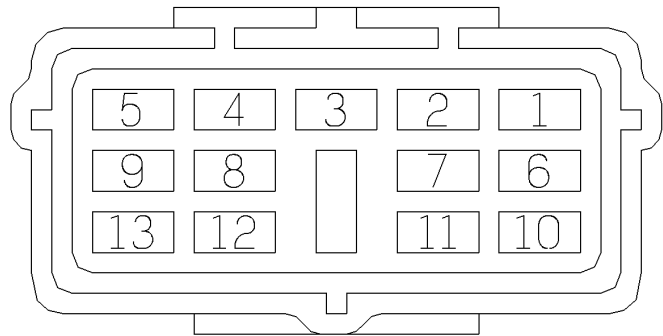

YPC10061

**(E)**

Mazo de cables principal al  
 mazo de cables de la  
 carrocería  
 Hembra  
 NEGRO  
 Pilar A izquierdo

Cav	Col	Cct	Cav	Col	Cct
1	GP	ALL	7	GB	ALL
2	UY	ALL	9	PK	ALL
3	GN	ALL	10	WP	ALL
4	GW	ALL	11	OR	ALL
5	GR	ALL	12	RW	ALL
6	RB	ALL	13	GY	ALL



# C489

## CONNECTOR / AANSLUITING / CONECTOR

**(GB)**

RH brake lamp  
Female  
BLACK  
Luggage compartment - RH  
side

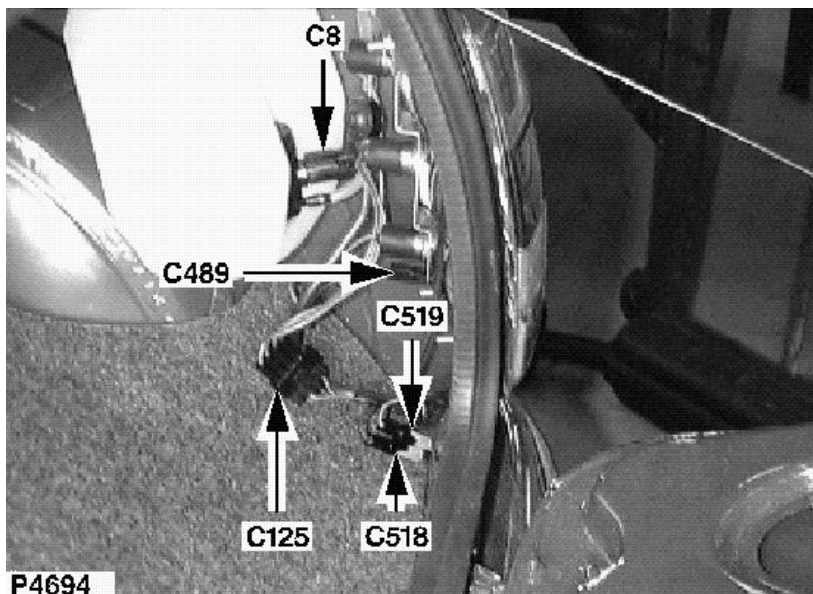

**(NL)**

Rechter remlicht  
Vrouwelijk  
ZWART  
bagageruimte - Rechts

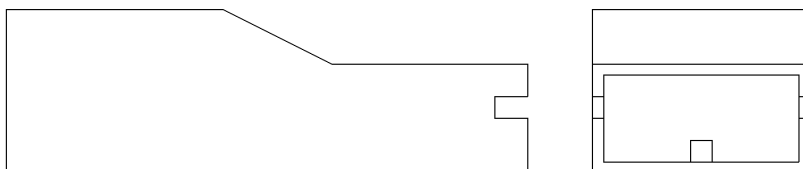

AAU1010

**(E)**

Luz de pare derecha  
Hembra  
NEGRO  
maletero - Lado derecho

Cav	Col	Cct
1	B	ALL

**(GB)**

LH brake lamp  
 Female  
 BLACK  
 Luggage compartment - LH  
 side

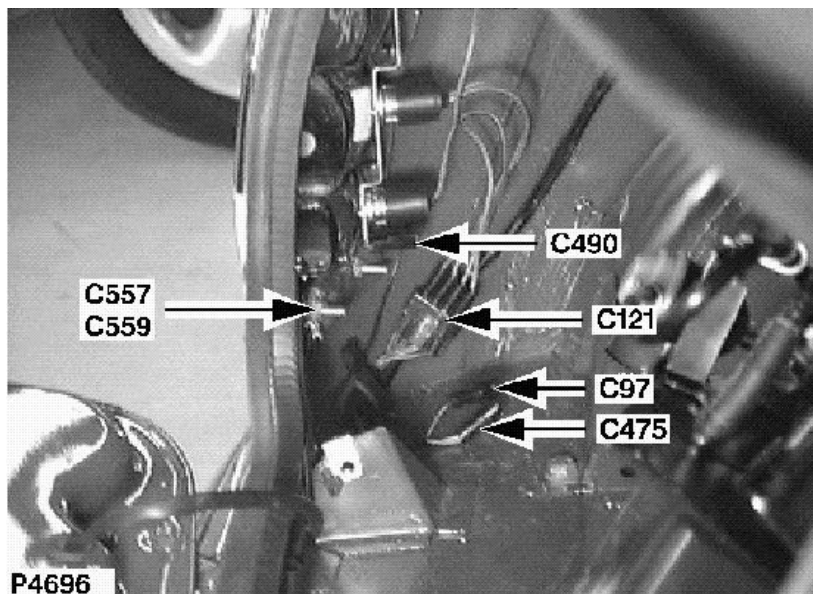
**(NL)**

Linker remlicht  
 Vrouwelijk  
 ZWART  
 bagageruimte - Links

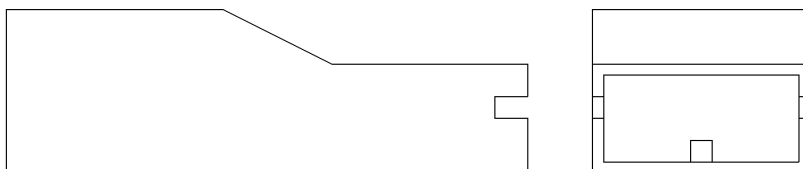

AAU1010

**(E)**

Luz de pare izquierda  
 Hembra  
 NEGRO  
 maletero - Lado izquierdo

Cav	Col	Cct
1	B	ALL

# C513

## CONNECTOR / AANSLUITING / CONECTOR

(GB)

RH front fog lamp  
Female  
WHITE  
Behind the front grille

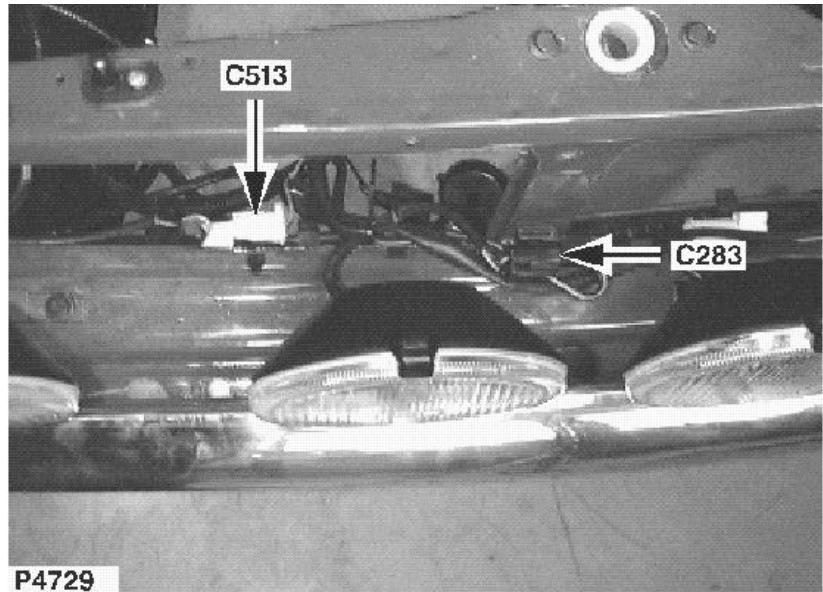

(NL)

Rechter voorste mistlamp  
Vrouwelijk  
WIT  
Achter voor-grille

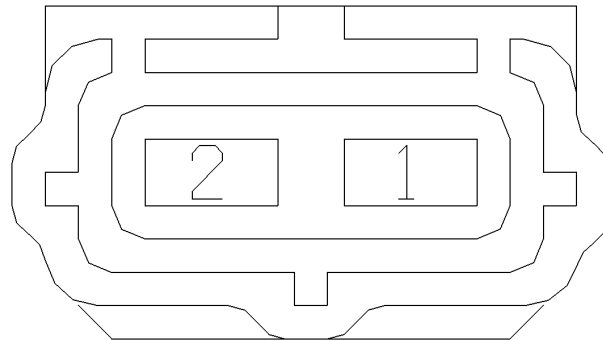

YPC10187

(E)

Piloto antiniebla delantero  
derecho  
Hembra  
BLANCO  
Detrás de la rejilla delantera

Cav	Col	Cct
1	UG	ALL
2	B	ALL

**(GB)**

LH front fog lamp  
 Female  
 WHITE  
 Behind the front grille

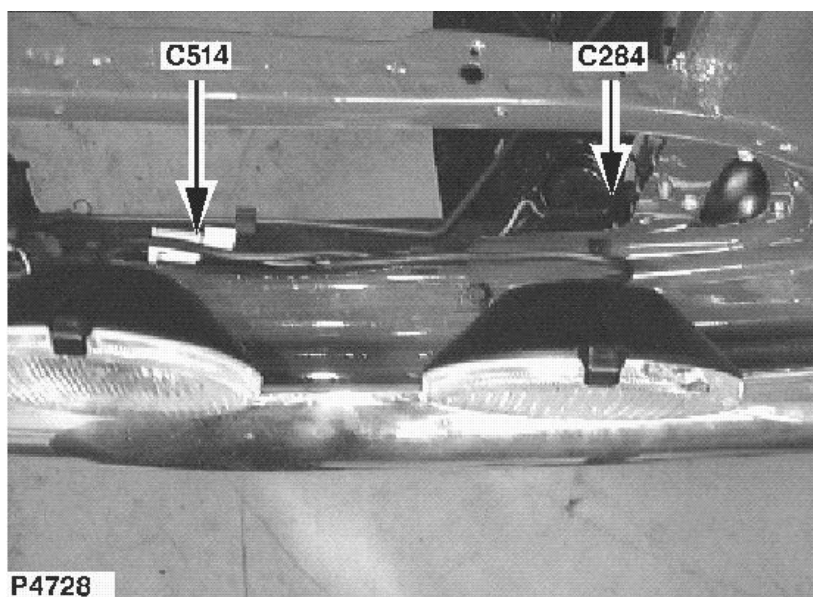
**(NL)**

Linker voorste mistlamp  
 Vrouwelijk  
 WIT  
 Achter voor-grille

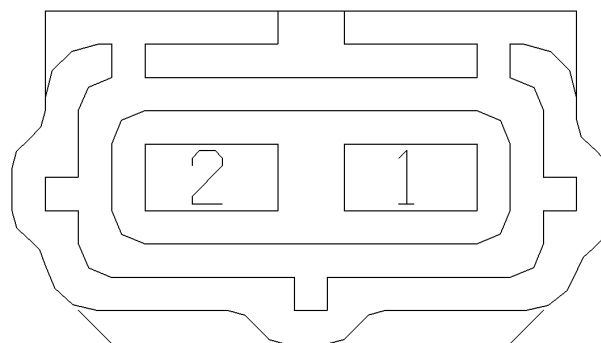

YPC10187

**(E)**

Faro antiniebla delantero  
 izquierdo  
 Hembra  
 BLANCO  
 Detrás de la rejilla delantera

Cav	Col	Cct
1	UG	ALL
2	B	ALL

# C518

## CONNECTOR / AANSLUITING / CONECTOR

**(GB)**

RH rear fog lamp  
Male  
BLACK  
Luggage compartment - RH  
side

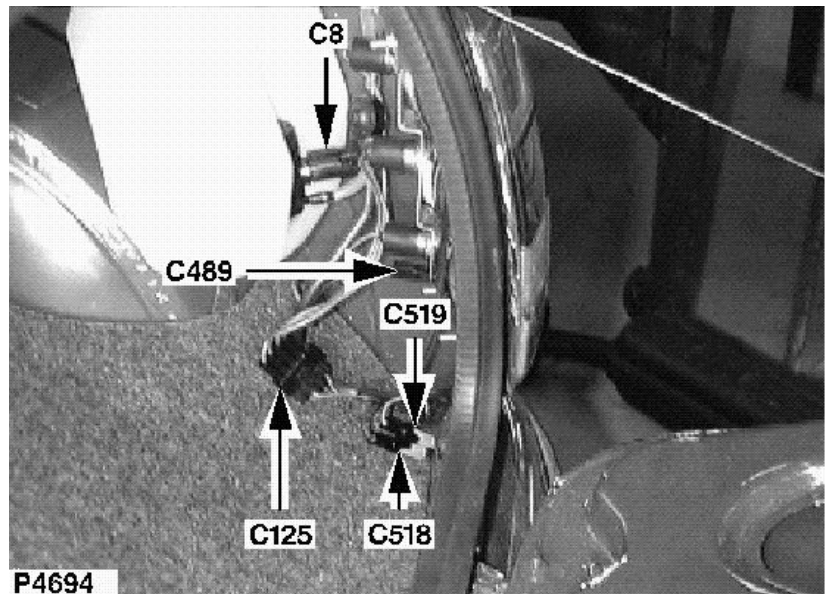

**(NL)**

Rechter mistachterlamp  
Mannelijk  
ZWART  
bagageruimte - Rechts

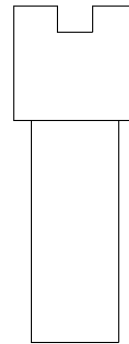

ADU2150

**(E)**

Piloto antiniebla trasero  
derecho  
Macho  
NEGRO  
maletero - Lado derecho

Cav	Col	Cct
1	B	ALL

**(GB)**

RH rear fog lamp

Male

BLACK

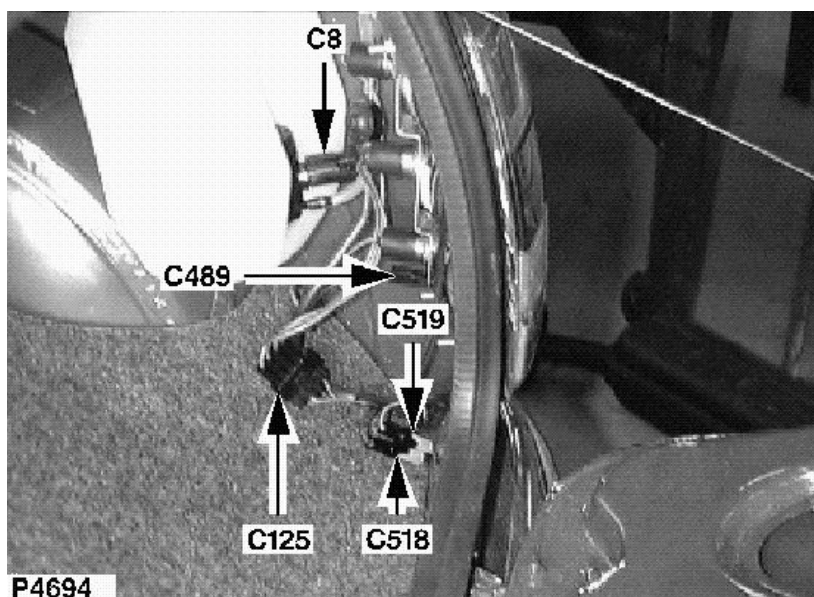
Luggage compartment - RH  
side**(NL)**

Rechter mistachterlamp

Mannelijk

ZWART

bagageruimte - Rechts

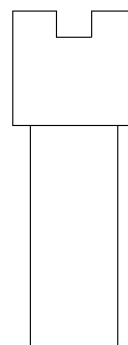

ADU2150

**(E)**Piloto antiniebla trasero  
derecho

Macho

NEGRO

maletero - Lado derecho

Cav	Col	Cct
1	UY	ALL

**(GB)**

Injectors  
Female  
BLACK  
Top rear of engine - centre

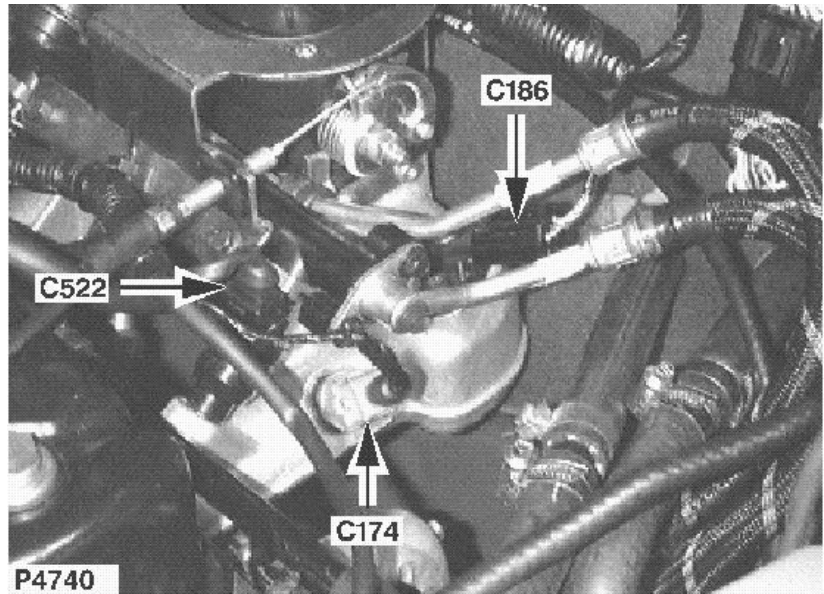

**(NL)**

Verstuivers  
Vrouwelijk  
ZWART  
boven/achterkant motor -  
midden

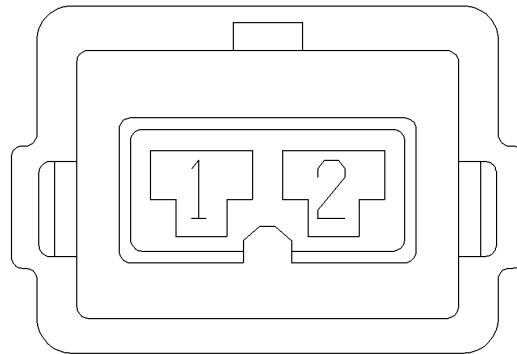

ALU1038

**(E)**

Inyectoros  
Hembra  
NEGRO  
parte superior trasera del  
motor - centro

Cav	Col	Cct
1	NK	ALL
2	YN	ALL

**(GB)**

Injectors  
Female  
BLACK  
Top rear of engine - centre

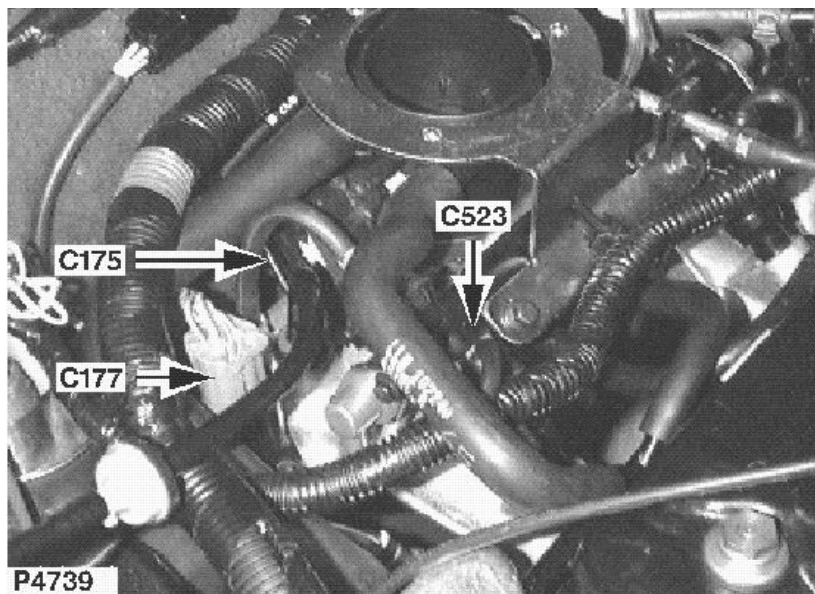
**(NL)**

Verstuivers  
Vrouwelijk  
ZWART  
boven/achterkant motor -  
midden

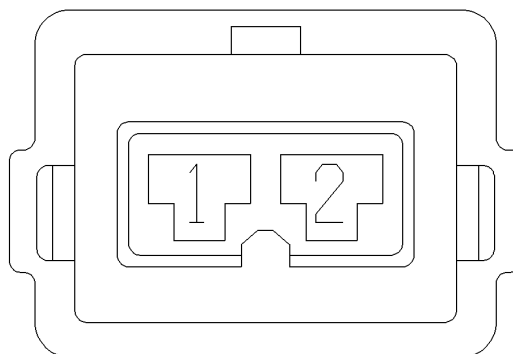

ALU1038

**(E)**

Inyectoros  
Hembra  
NEGRO  
parte superior trasera del  
motor - centro

Cav	Col	Cct
1	NK	ALL
2	YR	ALL



# C532

## CONNECTOR / AANSLUITING / CONECTOR

(GB)

Fog Lamp Harness to Main  
Harness  
Male  
BLACK  
Top of bulkhead - centre

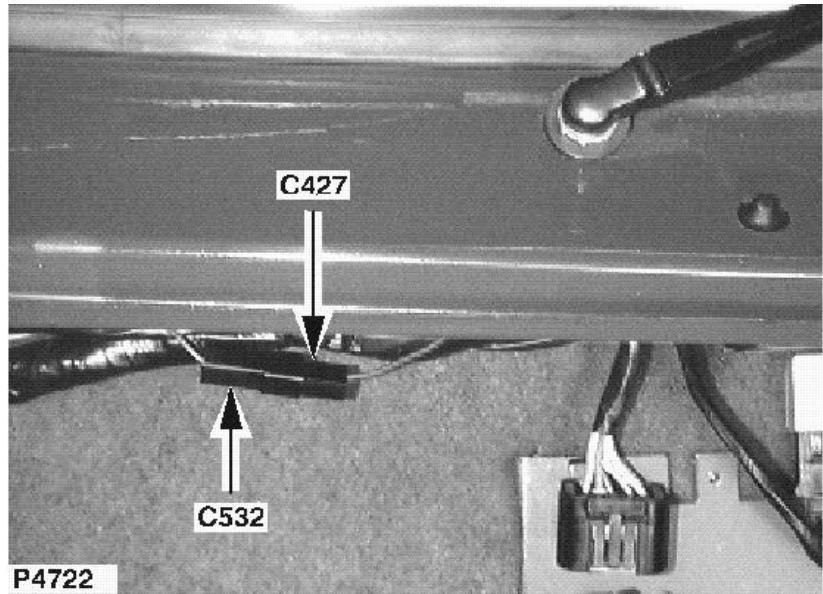

(NL)

Mistlamp-kabelbundel naar  
hoofdkabelbundel  
Mannelijk  
ZWART  
Bovenkant schutbord -  
midden

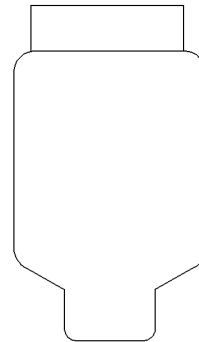

ULC1376

(E)

Mazo de cables de luces  
antiniebla al mazo de cables  
principal  
Macho  
NEGRO  
Parte superior del salpicadero  
- centro

Cav	Col	Cct
1	RB	ALL

**(GB)**

Driving lamp relay  
 Female  
 BLACK  
 Rear RH side of engine compartment

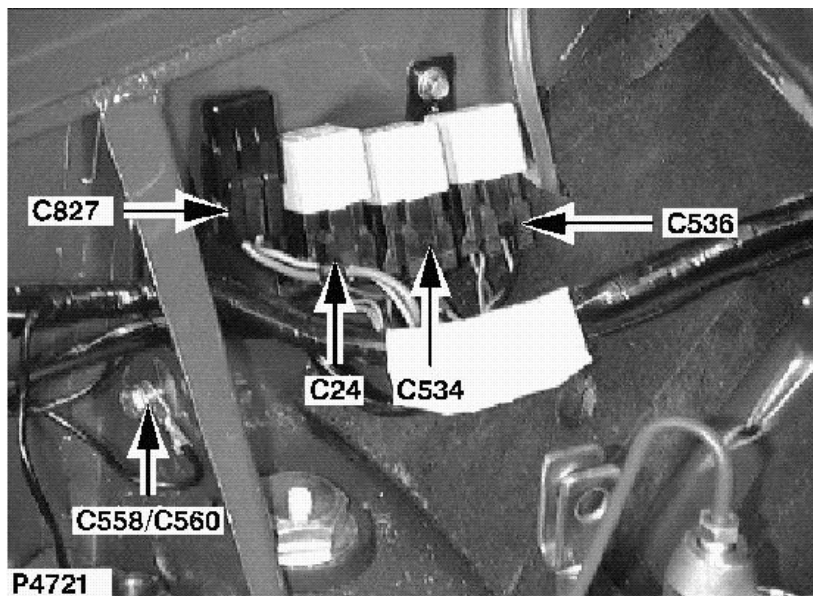

**(NL)**

Rijlampen - relais  
 Vrouwelijk  
 ZWART  
 Rechter achterkant motorcompartiment

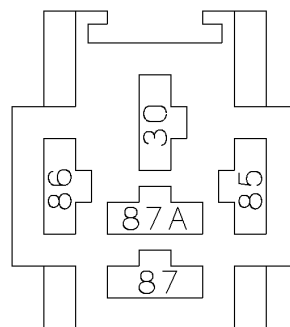

AGU1385

**(E)**

Relé de faros supletorios  
 Hembra  
 NEGRO  
 Parte trasera derecha del compartimento motor

Cav	Col	Cct
30	UY	ALL
85	UW	ALL
86	B	ALL
87	P	ALL

# C536

## CONNECTOR / AANSLUITING / CONECTOR

**(GB)**

Direction indicator relay  
Female  
BLACK  
Rear RH side of engine  
compartment

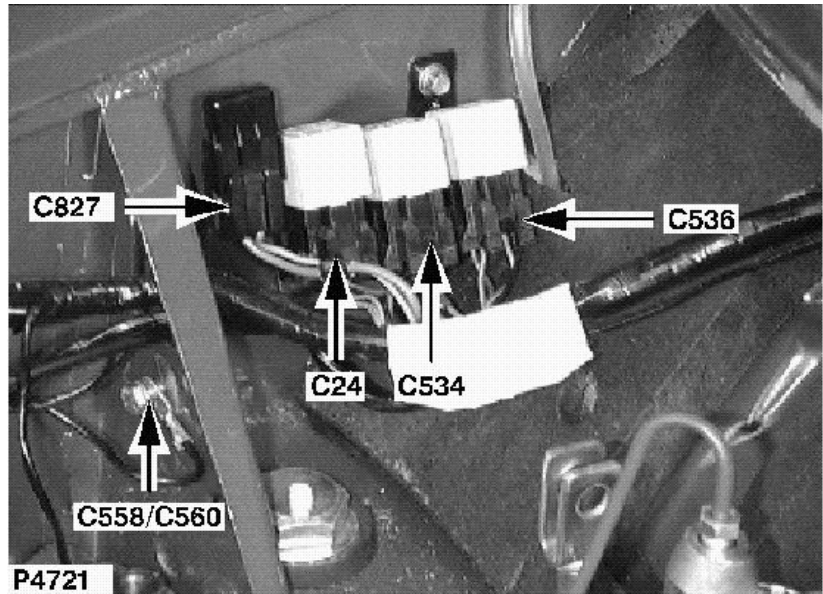

**(NL)**

Richtingaanwijzers - relais  
Vrouwelijk  
ZWART  
Rechter achterkant  
motorcompartiment

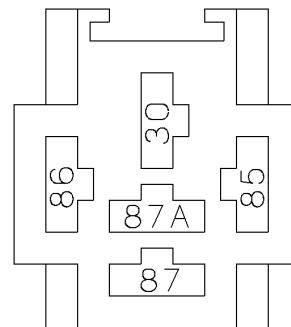

AGU1385

**(E)**

Relé de intermitentes de  
dirección  
Hembra  
NEGRO  
Parte trasera derecha del  
compartimento motor

Cav	Col	Cct
30	LGK	ALL
85	B	ALL
86	G	ALL
87	LGN	ALL

**(GB)**

Rotary coupler  
 Female  
 YELLOW  
 Underside of steering column

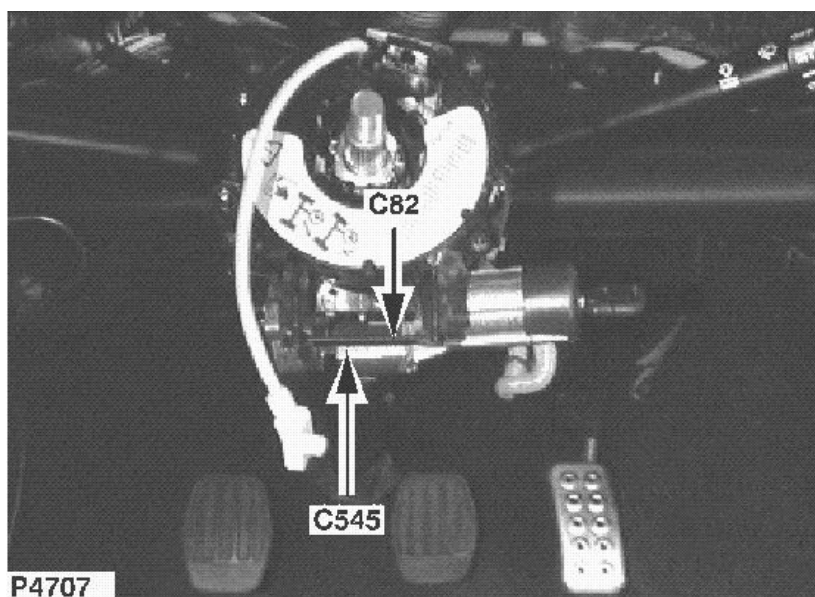
**(NL)**

ROTERENDE KOPPELING  
 Vrouwelijk  
 GEEL  
 onderkant van stuurkolom

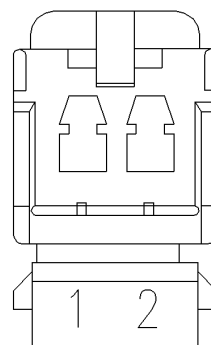

YPC106880

**(E)**

ACOPLADOR GIRATORIO  
 Hembra  
 AMARILLO  
 parte inferior de la columna  
 de dirección

Cav	Col	Cct
1	R	ALL
2	Y	ALL

# C546

## CONNECTOR / AANSLUITING / CONECTOR

**(GB)**

Front wiper control unit  
Female  
BLACK  
Behind centre of fascia

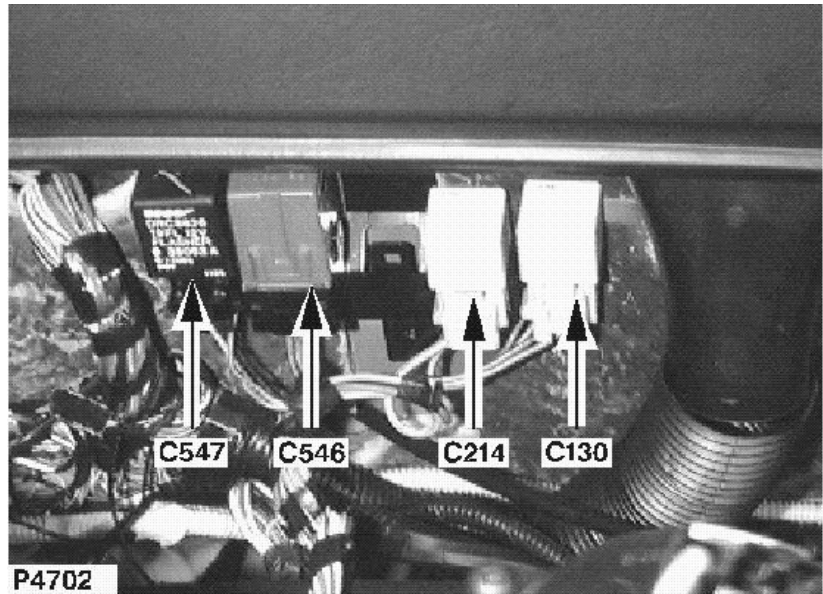

**(NL)**

Voorruitwissers -  
regeleenheid  
Vrouwelijk  
ZWART  
achter middelste gedeelte  
dashboard

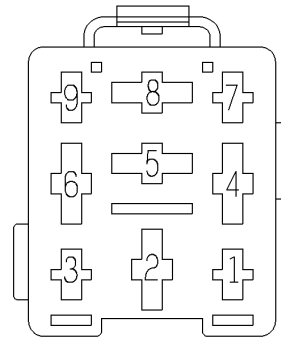

**(E)**

Unidad de control de  
limpiaparabrisas  
Hembra  
NEGRO  
detrás de la parte central del  
tablero

Cav	Col	Cct
2	NLG	ALL
4	B	ALL
5	NLG	ALL
6	OR	ALL
7	LGG	ALL
8	LGO	ALL

**(GB)**

Direction indicator/hazard  
warning unit  
Female  
BLACK  
Behind centre of fascia

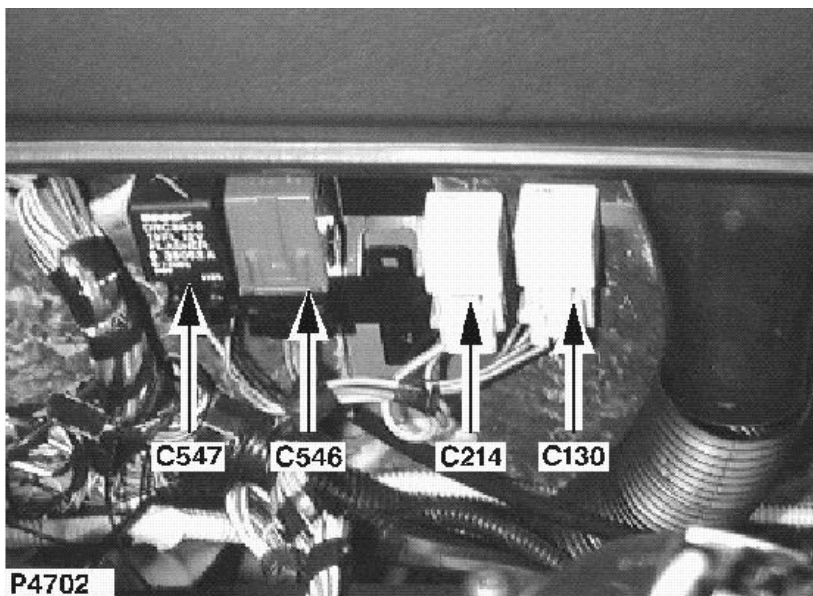
**(NL)**

Richtingaanwijzers/alarmknip  
perlichten  
Vrouwelijk  
ZWART  
achter middelste gedeelte  
dashboard

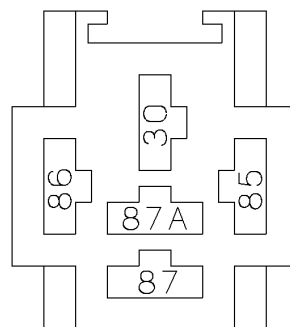

AGU1385

**(E)**

Central de intermitentes de  
dirección/emergencia  
Hembra  
NEGRO  
detrás de la parte central del  
tablero

Cav	Col	Cct
85	PO	ALL
86	B	ALL
87	LGK	ALL

# C550

## CONNECTOR / AANSLUITING / CONECTOR

(GB)

Earth header  
Female  
NATURAL  
LH side of engine  
compartment

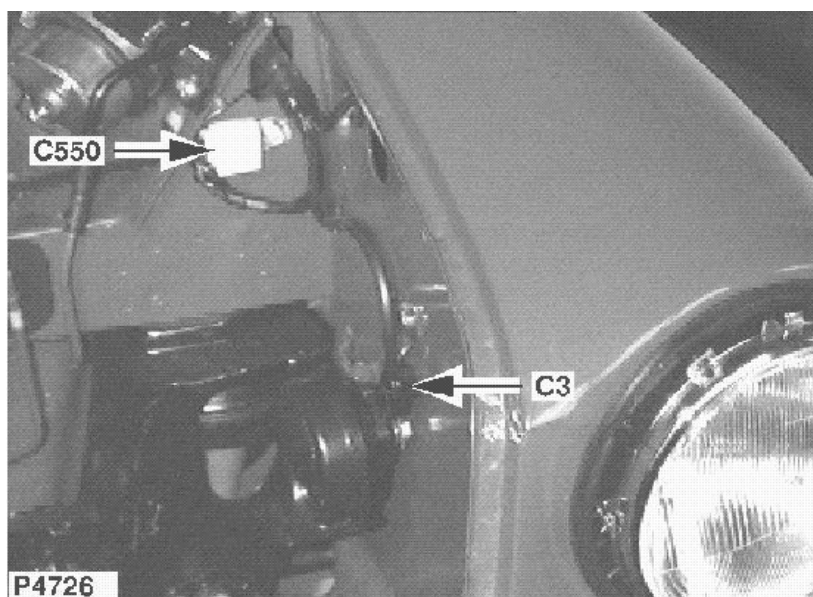

(NL)

Massa - stootrand  
Vrouwelijk  
NATUREL  
Linkerkant  
motorcompartiment

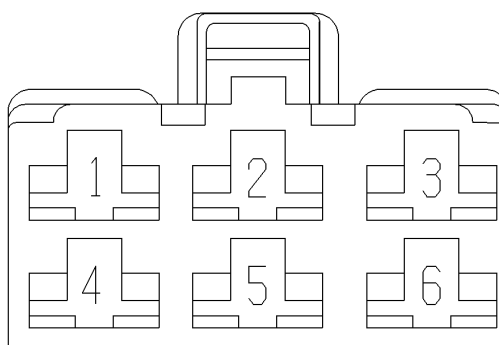

YPC10004

(E)

Unión de convergencia a  
masa  
Hembra  
NATURAL  
Lado izquierdo del  
compartimento motor

Cav	Col	Cct
1	B	ALL
2	B	ALL
3	B	ALL
4	B	ALL
5	B	ALL
6	B	ALL

**(GB)**

Earth Eyelet  
 Eyelet  
 TIN-PLATE  
 Luggage compartment - LH  
 side

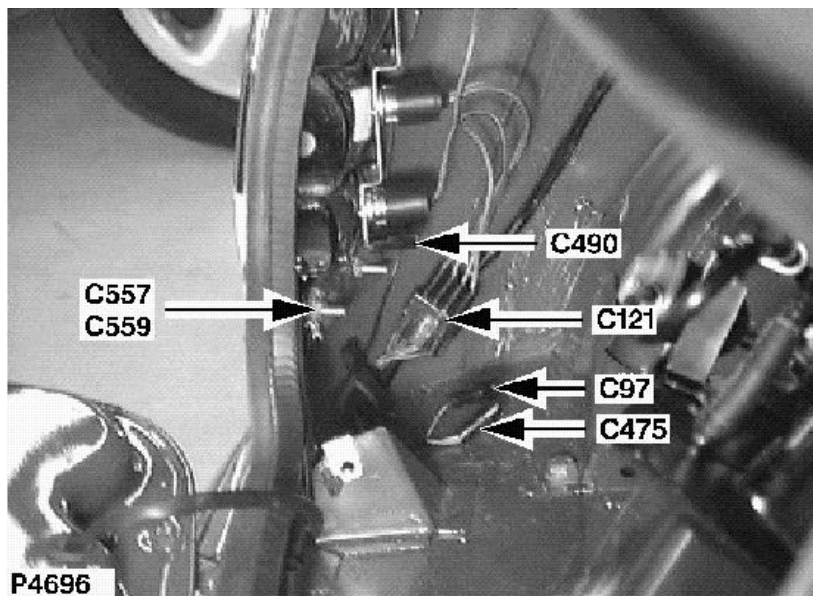

**(NL)**

Massa - oog-aansluiting  
 Oogje  
 VERTIND  
 bagageruimte - Links

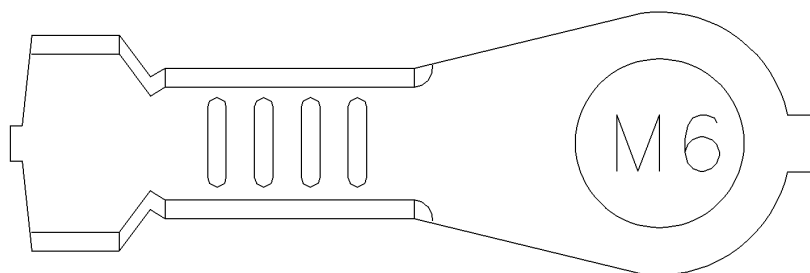

YPG10014

**(E)**

Ollao de masa  
 Ollao  
 PLACA ESTAÑO  
 maletero - Lado izquierdo

Cav	Col	Cct
1	B	ALL



**(GB)**

Earth Eyelet  
 Eyelet  
 TIN-PLATE  
 RH side of engine  
 compartment

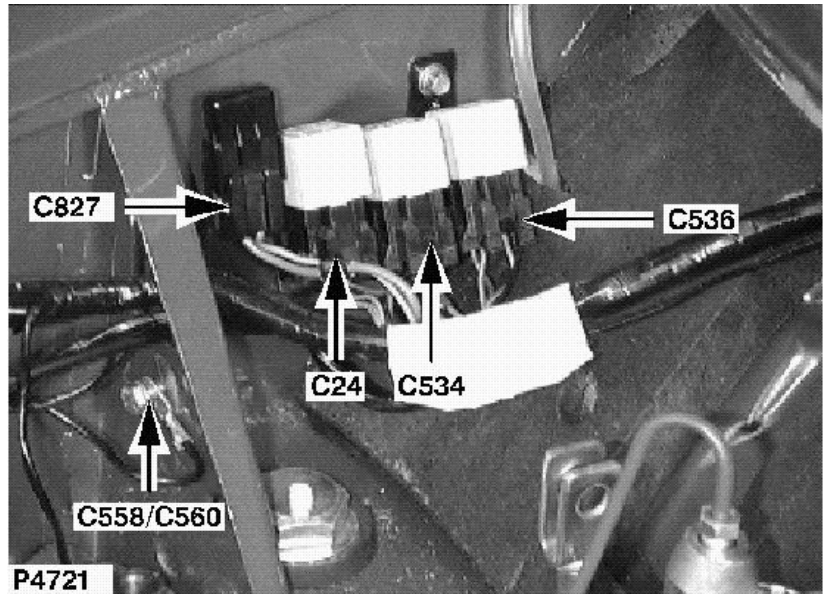

**(NL)**

Massa - oog-aansluiting  
 Oogje  
 VERTIND  
 Rechterkant  
 motorcompartiment

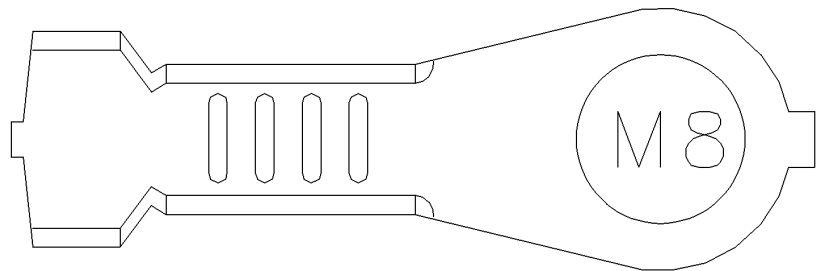

YPG10016

**(E)**

Ollao de masa  
 Ollao  
 PLACA ESTAÑO  
 Lado derecho del  
 compartimento motor

Cav	Col	Cct
1	B	ALL

**(GB)**

Earth Eyelet  
 Eyelet  
 TIN-PLATE  
 Luggage compartment - LH  
 side

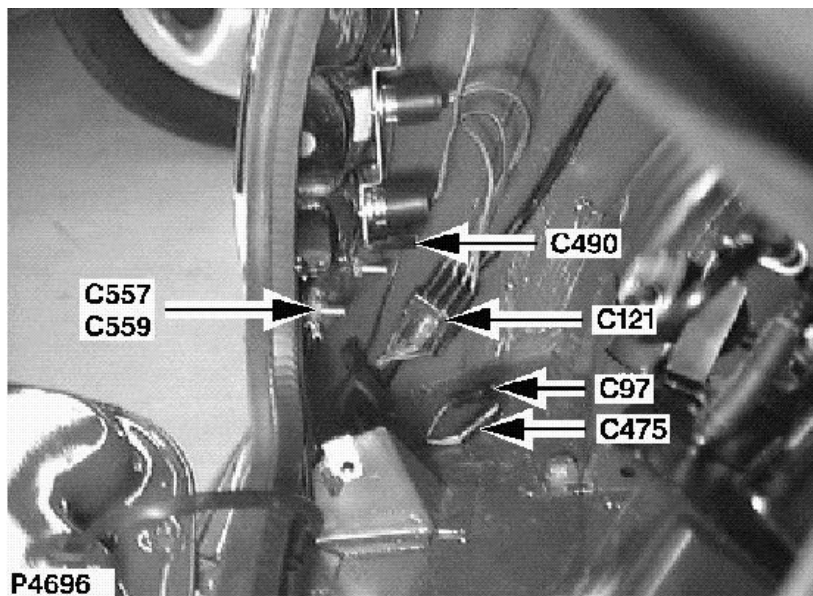

**(NL)**

Massa - oog-aansluiting  
 Oogje  
 VERTIND  
 bagageruimte - Links

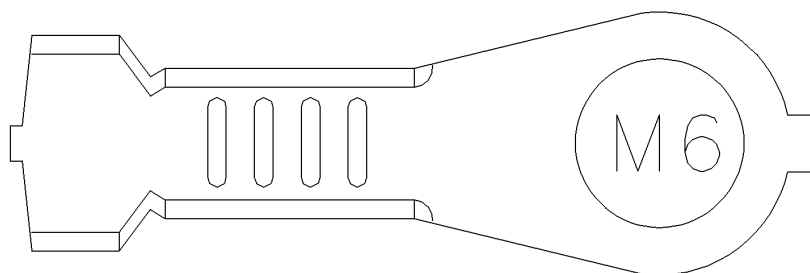

YPG10014

**(E)**

Ollao de masa  
 Ollao  
 PLACA ESTAÑO  
 maletero - Lado izquierdo

Cav	Col	Cct
1	B	ALL

# C561

## CONNECTOR / AANSLUITING / CONECTOR

**(GB)**

Earth 6  
Eyelet  
TIN-PLATE  
Beneath rear seat

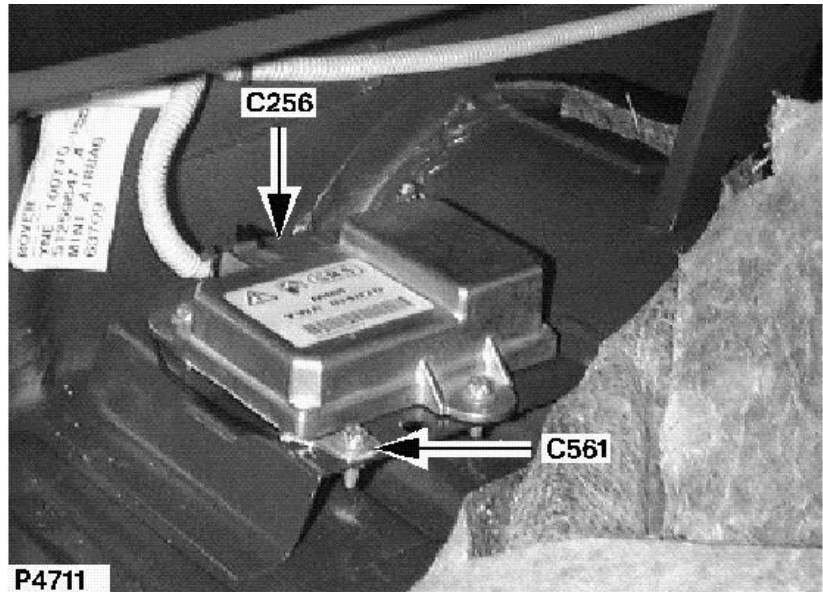

**(NL)**

Massa 6  
Oogje  
VERTIND  
Onder achterbank

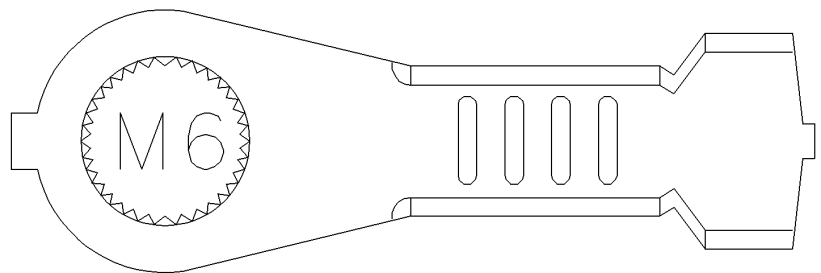

YPG100830

**(E)**

Masa 6  
Ollao  
PLACA ESTAÑO  
Debajo del asiento trasero

Cav	Col	Cct
1	B	ALL

(GB)

Oil temperature gauge  
Female  
BLACK  
Behind centre of fascia

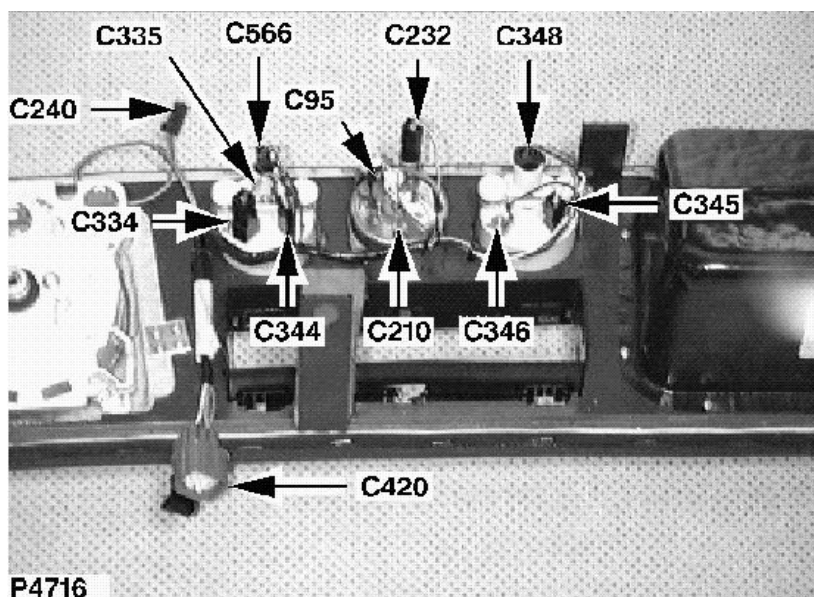

(NL)

OLIETEMPERATUURMETE  
R  
Vrouwelijk  
ZWART  
achter middelste gedeelte  
dashboard

(E)

INDICADOR DE  
TEMPERATURA DEL  
ACEITE  
Hembra  
NEGRO  
detrás de la parte central del  
tablero

Cav	Col	Cct
1	RW	ALL
2	B	ALL

# C570

## CONNECTOR / AANSLUITING / CONECTOR

**(GB)**

Engine compartment fusebox  
Female  
BLACK  
Top of engine - RH side

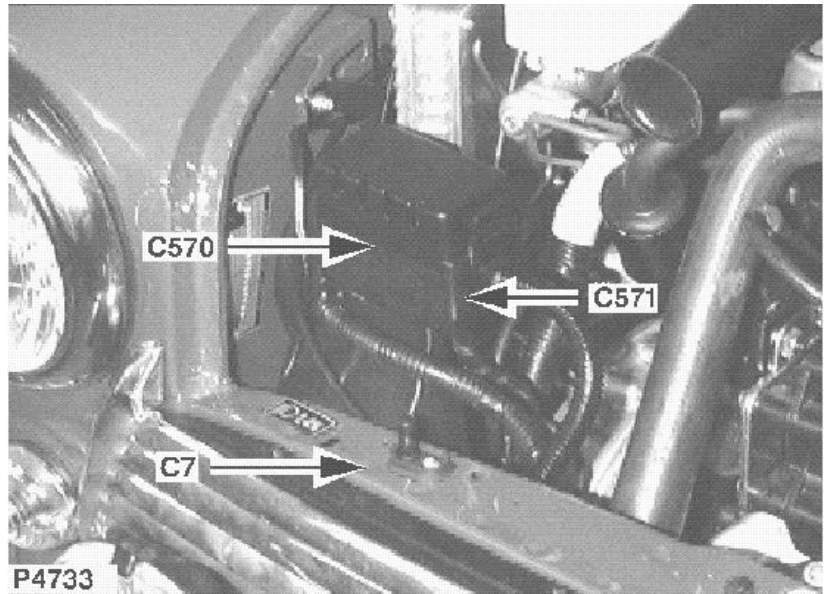

**(NL)**

Zekeringenkastje in  
motorcompartiment  
Vrouwelijk  
ZWART  
bovenkant motor - Rechts

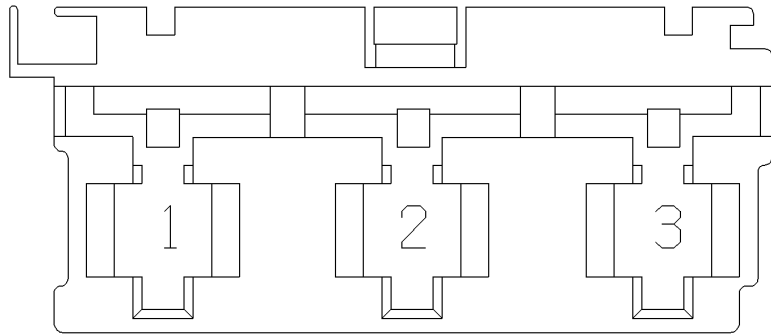

YPC10143

**(E)**

Caja de fusibles del  
compartimento motor  
Hembra  
NEGRO  
parte superior del motor -  
Lado derecho

Cav	Col	Cct
1	N	ALL
2	N	ALL
3	N	ALL

**(GB)**

Engine compartment fusebox  
 Female  
 BLACK  
 Top of engine - RH side

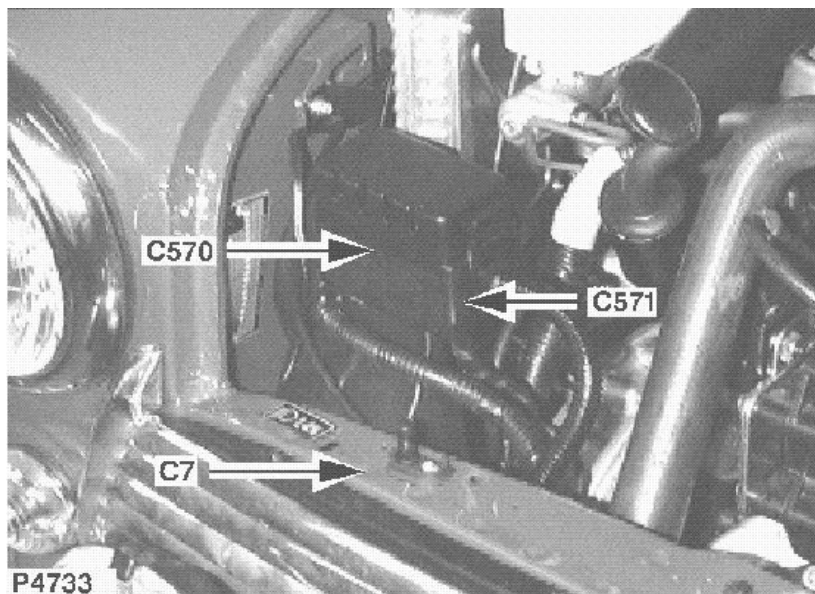
**(NL)**

Zekeringenkastje in  
 motorcompartiment  
 Vrouwelijk  
 ZWART  
 bovenkant motor - Rechts

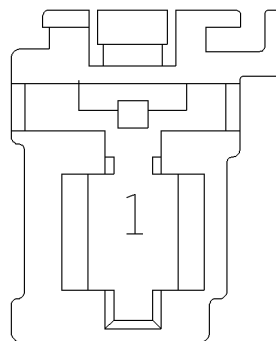

YPC10142

**(E)**

Caja de fusibles del  
 compartimento motor  
 Hembra  
 NEGRO  
 parte superior del motor -  
 Lado derecho

Cav	Col	Cct
1	N	ALL

**(GB)**

Starter  
Eyelet  
TIN-PLATE  
Lower front of engine - RH  
side

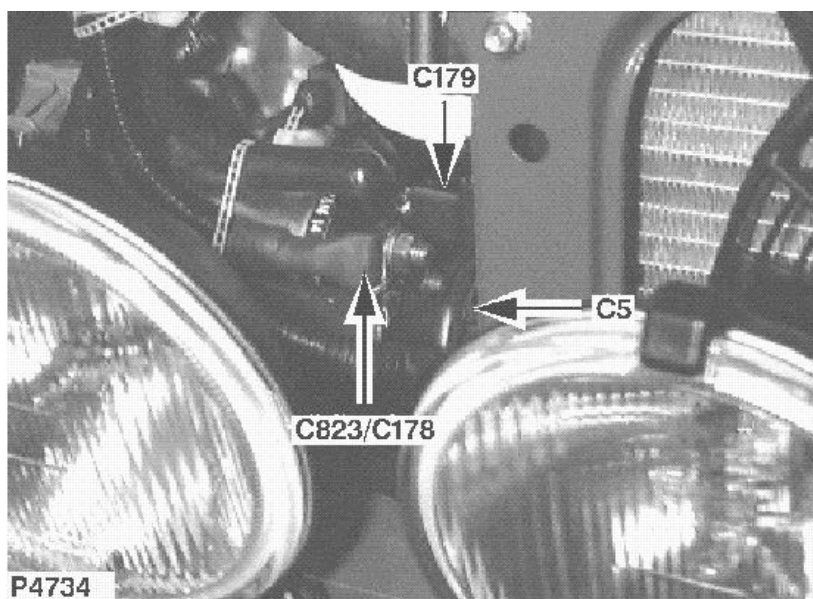

**(NL)**

Startmotor  
Oogje  
VERTIND  
Onder/voorkant motor -  
Rechts

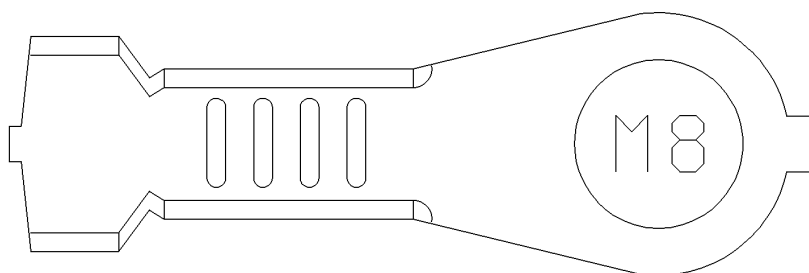

YPG10015

**(E)**

Motor de arranque  
Ollao  
PLACA ESTAÑO  
Parte delantera inferior del  
motor - Lado derecho

Cav	Col	Cct
1	N	ALL

**(GB)**

Fuse holder  
 Female  
 TIN-PLATE  
 Rear RH side of engine  
 compartment

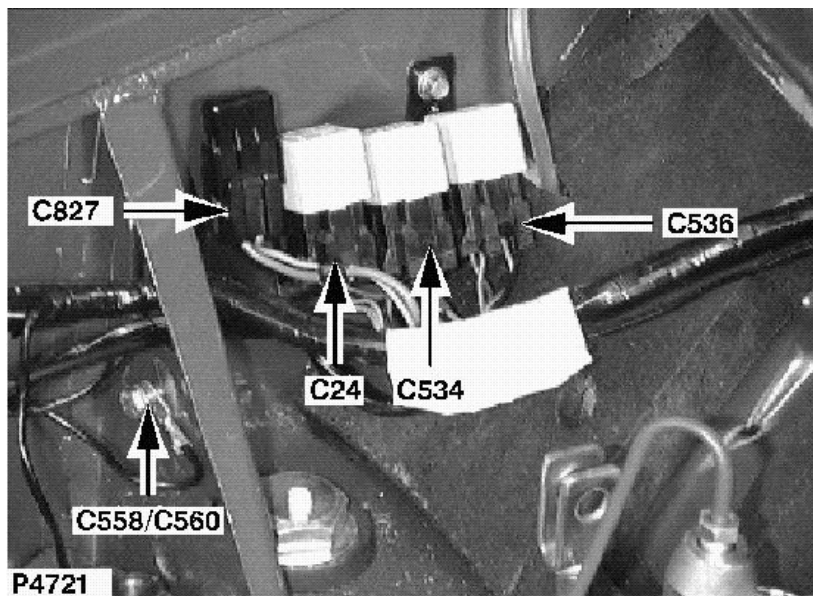

**(NL)**

Zekeringhouder  
 Vrouwelijk  
 VERTIND  
 Rechter achterkant  
 motorcompartiment

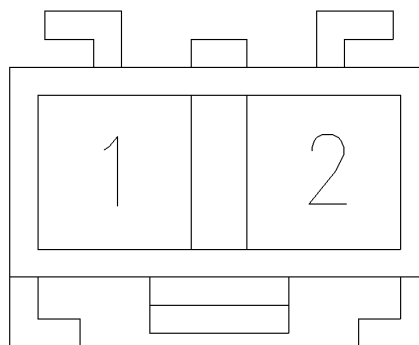

AFU3605

**(E)**

Portafusibles  
 Hembra  
 PLACA ESTAÑO  
 Parte trasera derecha del  
 compartimento motor

Cav	Col	Cct
1	PU	ALL
2	N	ALL



# C829

## CONNECTOR / AANSLUITING / CONECTOR

(GB)

Fog Lamp Link Harness  
Female  
BLACK  
LH side of bulkhead

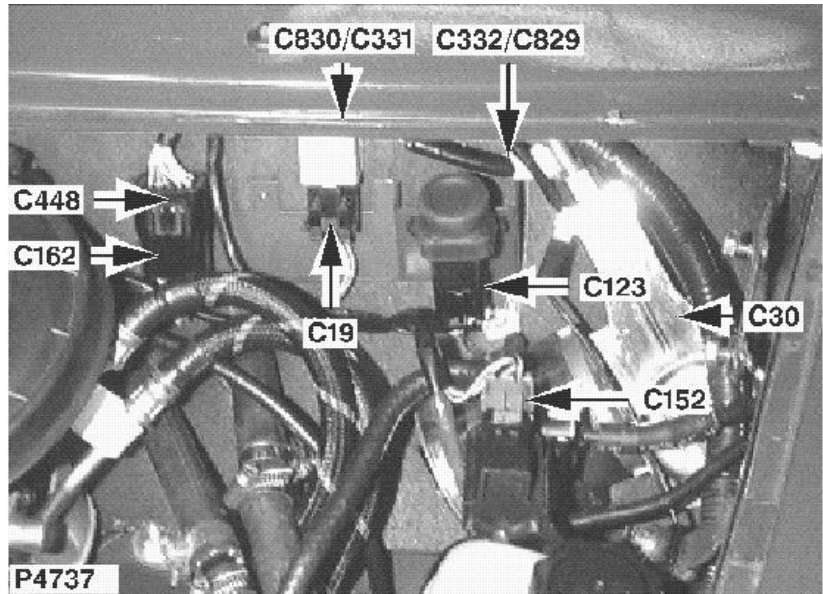

(NL)

Verbindingskabelbundel voor  
mistlampen  
Vrouwelijk  
ZWART  
Linkerkant tussenschot

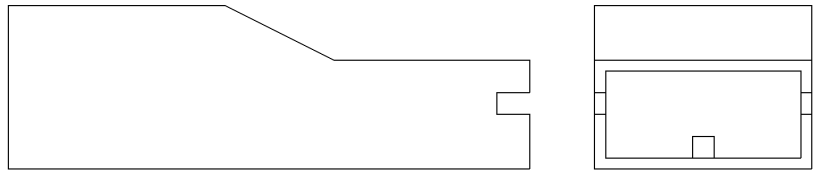

AAU1010

(E)

Mazo de cables de enlace de  
luces antiniebla  
Hembra  
NEGRO  
Lado izquierdo del  
salpicadero

Cav	Col	Cct
1	UW	ALL

**(GB)**

Fog Lamp Link Harness  
 Male  
 NATURAL  
 LH side of bulkhead

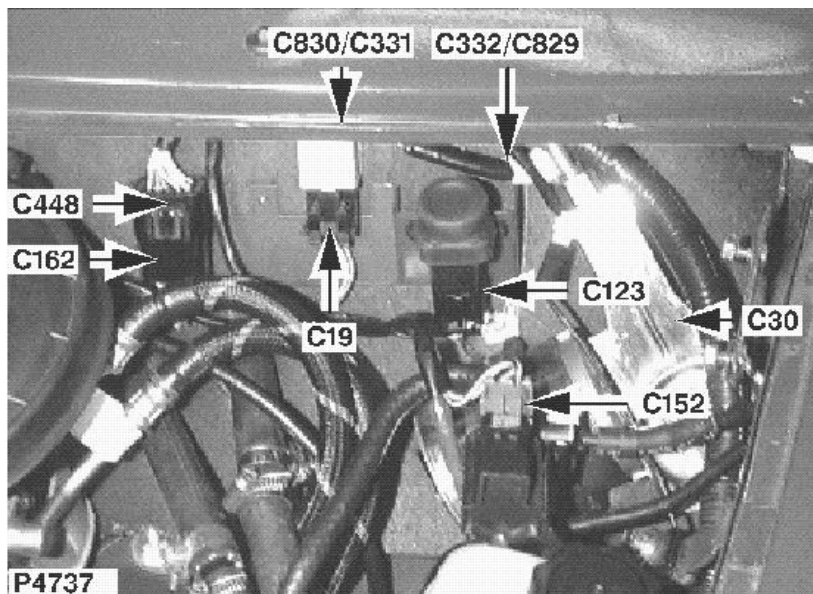

**(NL)**

Verbindingskabelbundel voor  
 mistlampen  
 Mannelijk  
 NATUREL  
 Linkerkant tussenschot

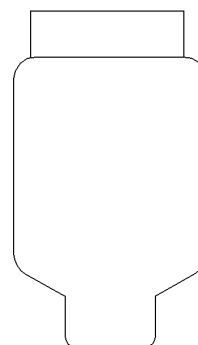

13H9632

**(E)**

Mazo de cables de enlace de  
 luces antiniebla  
 Macho  
 NATURAL  
 Lado izquierdo del  
 salpicadero

Cav	Col	Cct
1	UB	ALL

# C908

## CONNECTOR / AANSLUITING / CONECTOR

(GB)

Rear fog lamp switch  
Female  
BRASS  
Behind centre of fascia

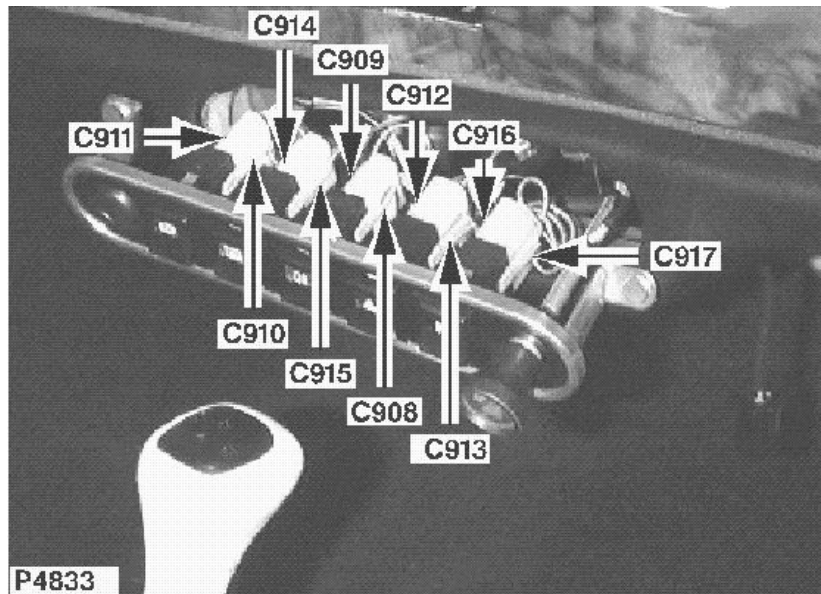

(NL)

Mistachterlamp - schakelaar  
Vrouwelijk  
KOPER  
achter middelste gedeelte  
dashboard

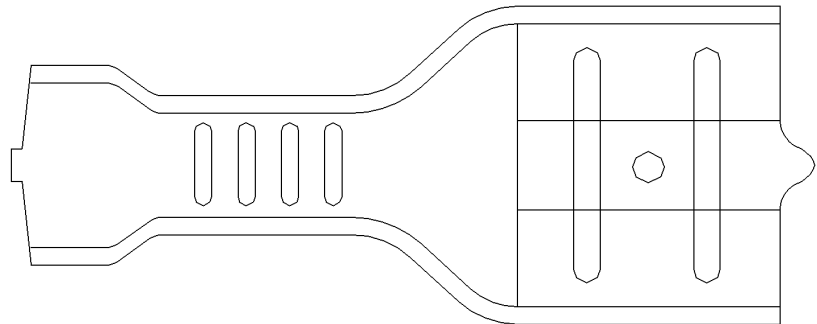

(E)

Interruptor de pilotos  
antiniebla traseros  
Hembra  
LATON  
detrás de la parte central del  
tablero

Cav	Col	Cct
1	UY	ALL

**(GB)**

Rear fog lamp switch  
Female  
BRASS  
Behind centre of fascia

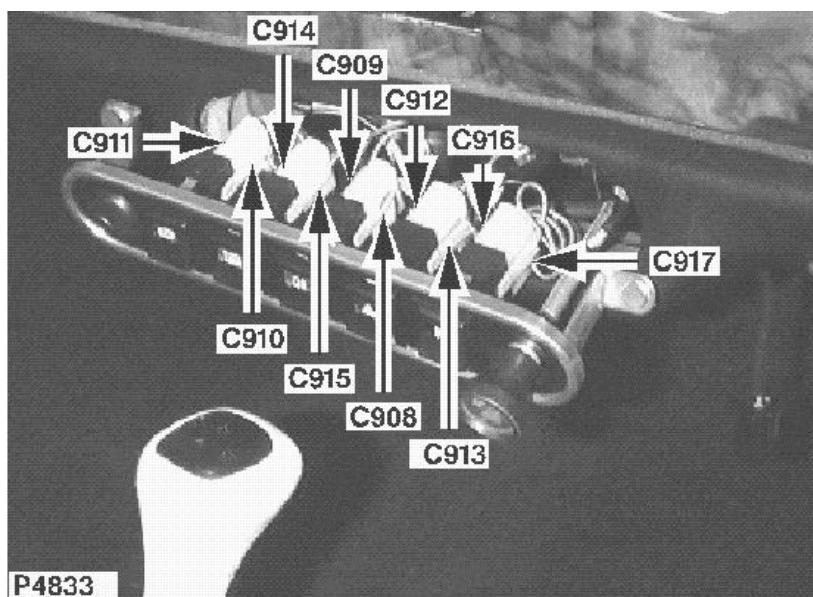
**(NL)**

Mistachterlamp - schakelaar  
Vrouwelijk  
KOPER  
achter middelste gedeelte  
dashboard

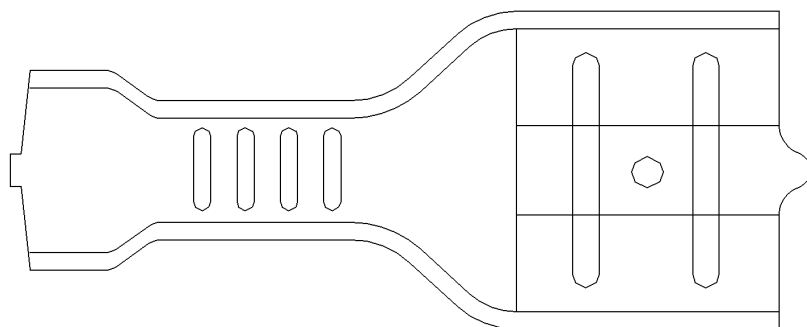

YPL10104

**(E)**

Interruptor de pilotos  
antiniebla traseros  
Hembra  
LATON  
detrás de la parte central del  
tablero

Cav	Col	Cct
1	B	ALL

# C910

## CONNECTOR / AANSLUITING / CONECTOR

(GB)

Brake system warning light  
Female  
BRASS  
Behind centre of fascia

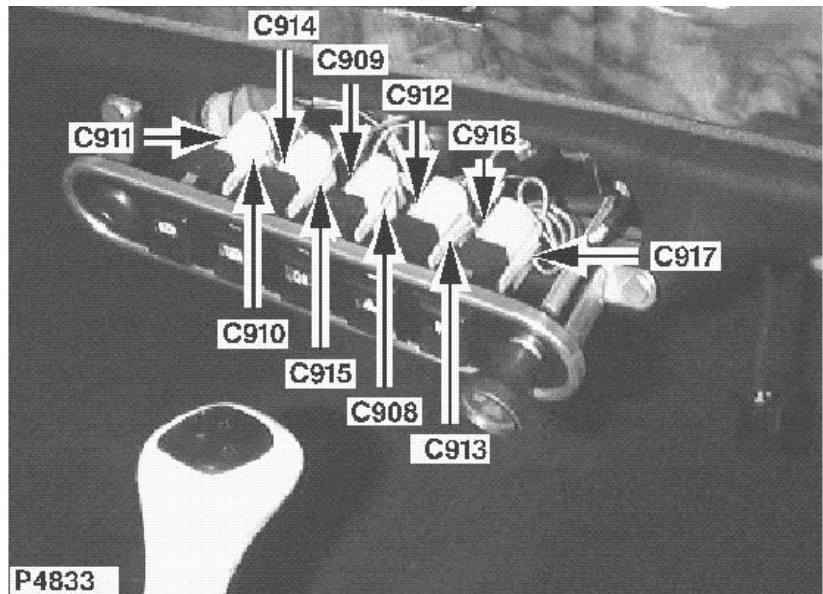

(NL)

Remsysteem -  
waarschuwingslampje  
Vrouwelijk  
KOPER  
achter middelste gedeelte  
dashboard

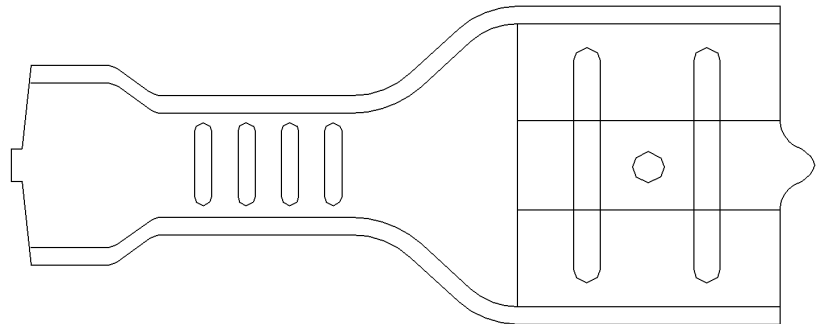

YPL10104

(E)

Luz testigo del sistema de  
frenos  
Hembra  
LATON  
detrás de la parte central del  
tablero

Cav	Col	Cct
1	PO	ALL

**(GB)**

Brake system warning light  
 Female  
 BRASS  
 Behind centre of fascia

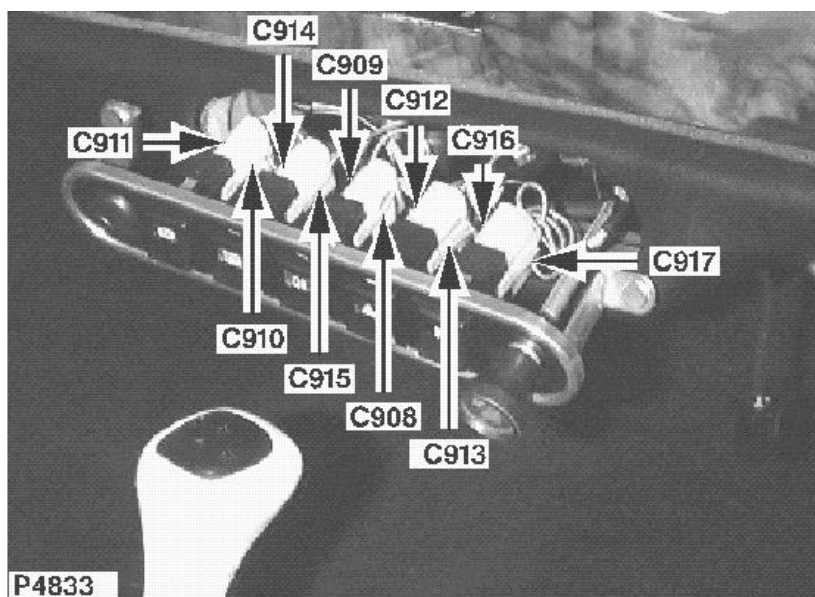
**(NL)**

Remsysteem -  
 waarschuwingslampje  
 Vrouwelijk  
 KOPER  
 achter middelste gedeelte  
 dashboard

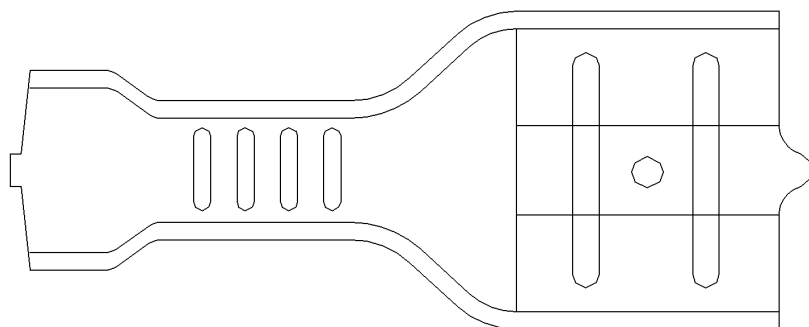

YPL10104

**(E)**

Luz testigo del sistema de  
 frenos  
 Hembra  
 LATON  
 detrás de la parte central del  
 tablero

Cav	Col	Cct
1	BW	ALL

# C912

## CONNECTOR / AANSLUITING / CONECTOR

(GB)

Hazard warning light  
Female  
BRASS  
Behind centre of fascia

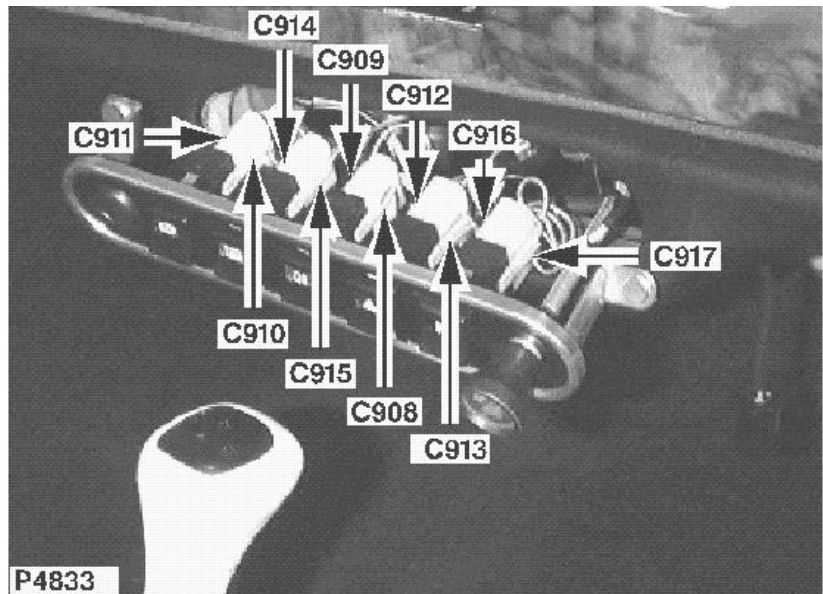

(NL)

Alarmknipperlicht  
Vrouwelijk  
KOPER  
achter middelste gedeelte  
dashboard

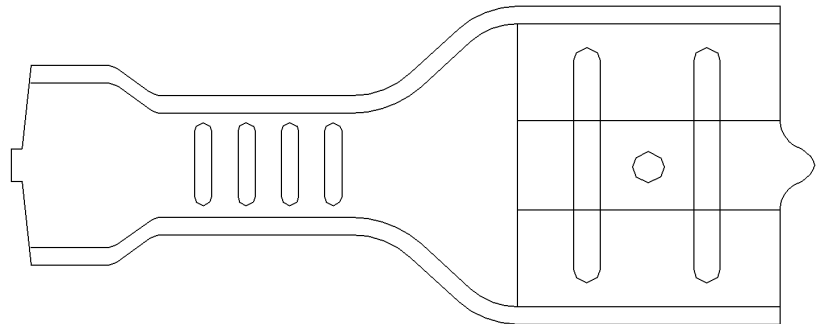

(E)

Luz intermitente de  
emergencia  
Hembra  
LATON  
detrás de la parte central del  
tablero

Cav	Col	Cct
1	B	ALL

**(GB)**

Hazard warning light  
Female  
BRASS  
Behind centre of fascia

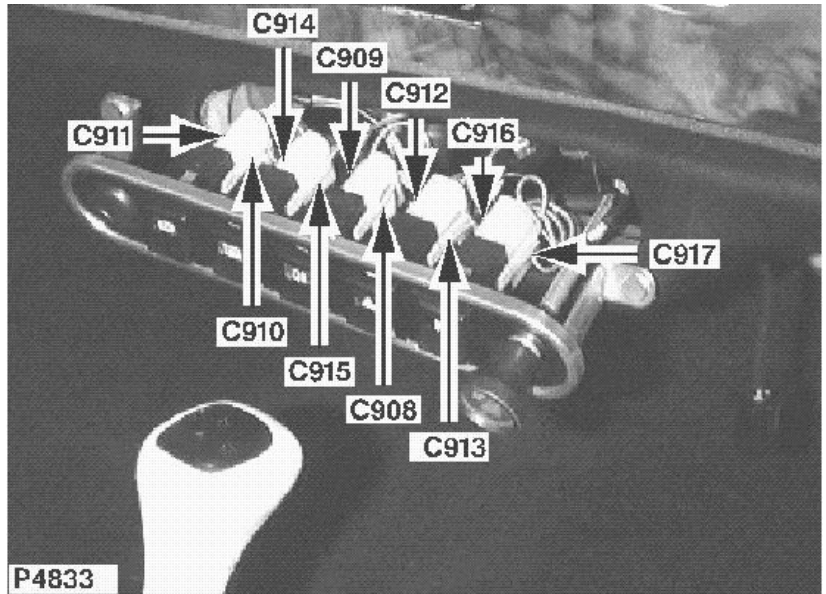

**(NL)**

Alarmknipperlicht  
Vrouwelijk  
KOPER  
achter middelste gedeelte  
dashboard

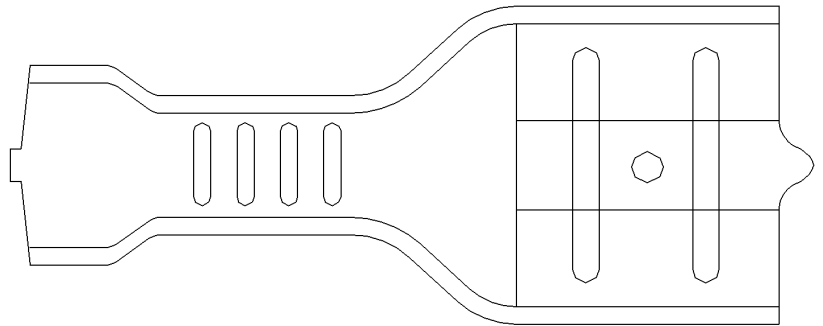

YPL10104

**(E)**

Luz intermitente de  
emergencia  
Hembra  
LATON  
detrás de la parte central del  
tablero

Cav	Col	Cct
1	GLG	ALL



# C914

## CONNECTOR / AANSLUITING / CONECTOR

(GB)

Heated rear window switch  
Female  
BRASS  
Behind centre of fascia

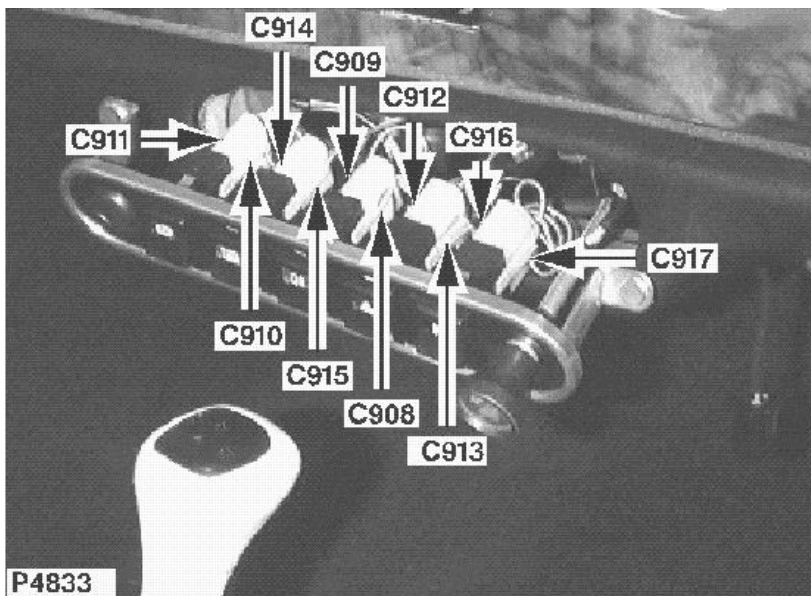

(NL)

Verwarmde achterrait -  
schakelaar  
Vrouwelijk  
KOPER  
achter middelste gedeelte  
dashboard

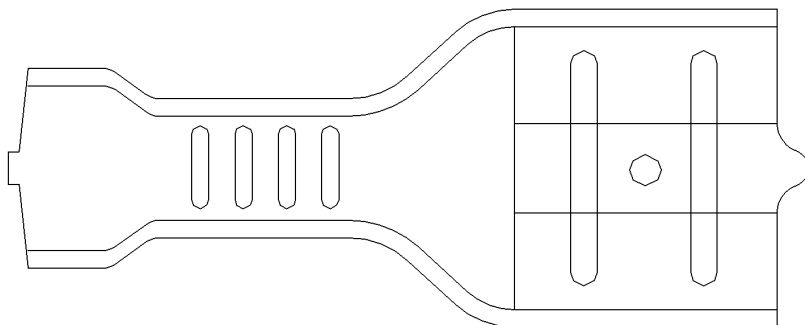

(E)

Interruptor de luneta térmica  
Hembra  
LATON  
detrás de la parte central del  
tablero

Cav	Col	Cct
1	B	ALL

**(GB)**

Heated rear window switch  
Female  
BRASS  
Behind centre of fascia

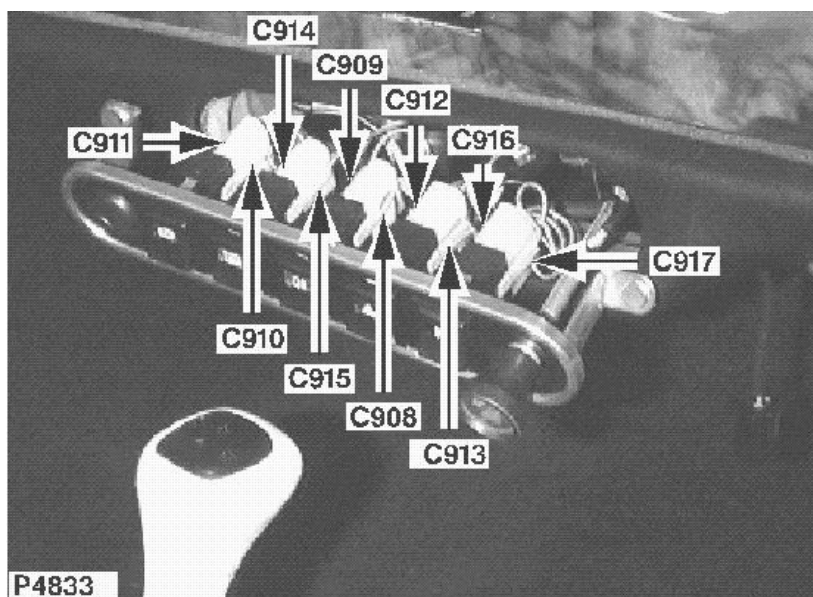
**(NL)**

Verwarmde achterraut -  
schakelaar  
Vrouwelijk  
KOPER  
achter middelste gedeelte  
dashboard

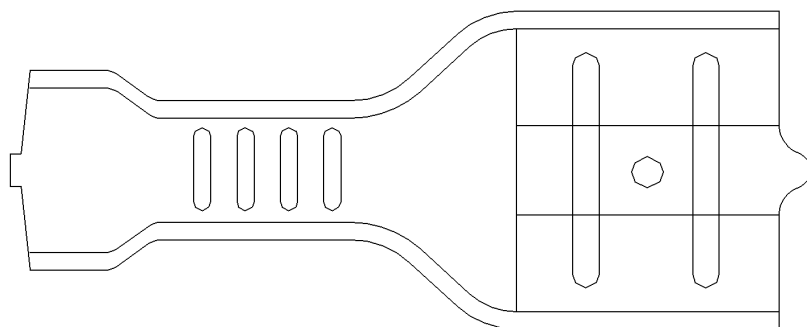

YPL10104

**(E)**

Interruptor de luneta térmica  
Hembra  
LATON  
detrás de la parte central del  
tablero

Cav	Col	Cct
1	GY	ALL

# C916

## CONNECTOR / AANSLUITING / CONECTOR

**(GB)**

Front fog lamp switch  
Female  
BRASS  
Behind centre of fascia

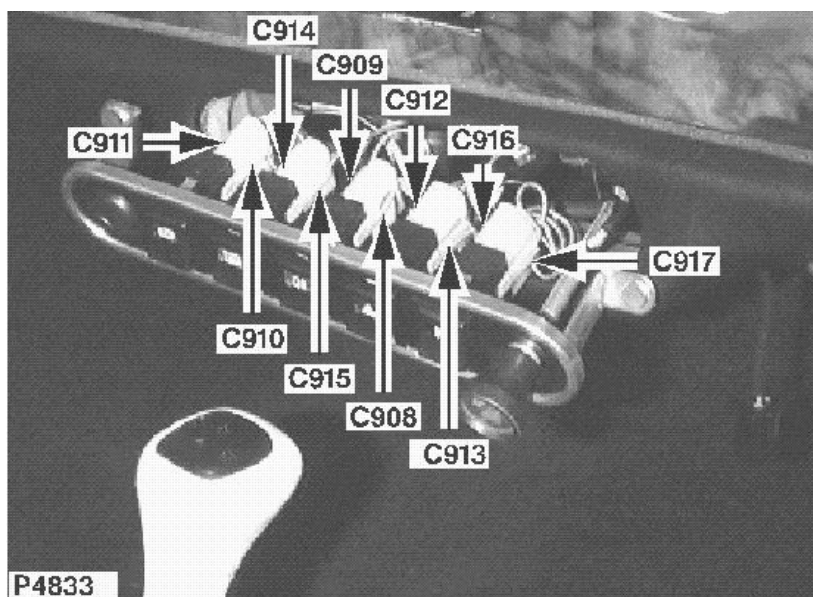

**(NL)**

Mistlamp voor - schakelaar  
Vrouwelijk  
KOPER  
achter middelste gedeelte  
dashboard

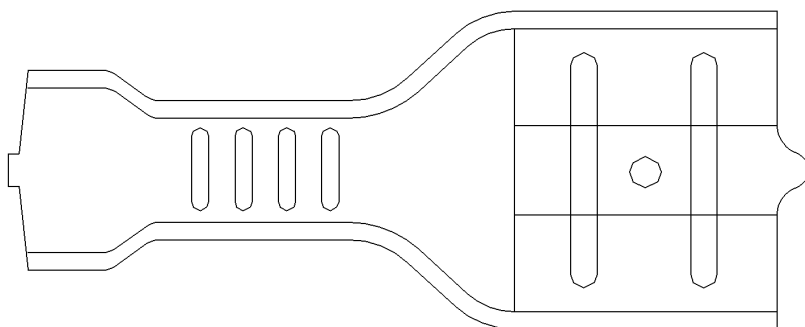

YPL10104

**(E)**

Interruptor de faros antiniebla  
delanteros  
Hembra  
LATON  
detrás de la parte central del  
tablero

Cav	Col	Cct
1	B	ALL

**(GB)**

Front fog lamp switch  
 Female  
 BRASS  
 Behind centre of fascia

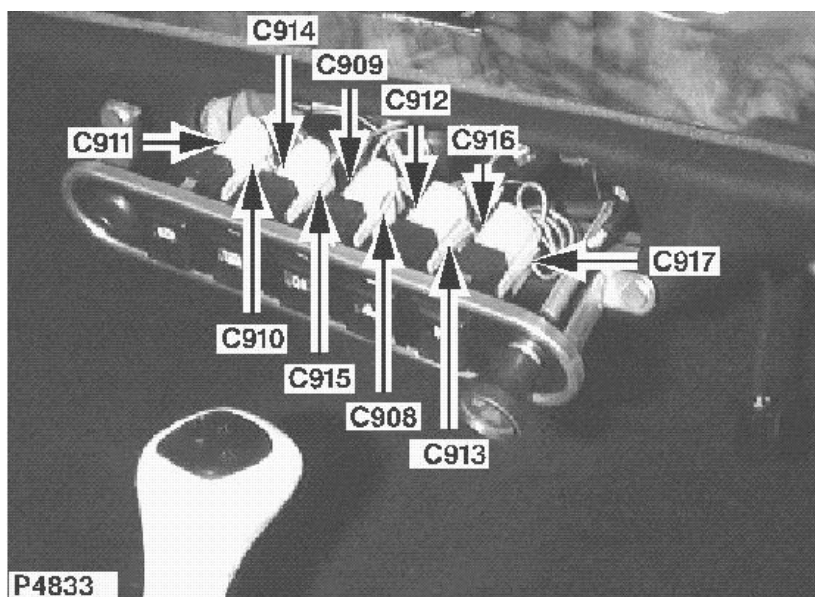
**(NL)**

Mistlamp voor - schakelaar  
 Vrouwelijk  
 KOPER  
 achter middelste gedeelte  
 dashboard

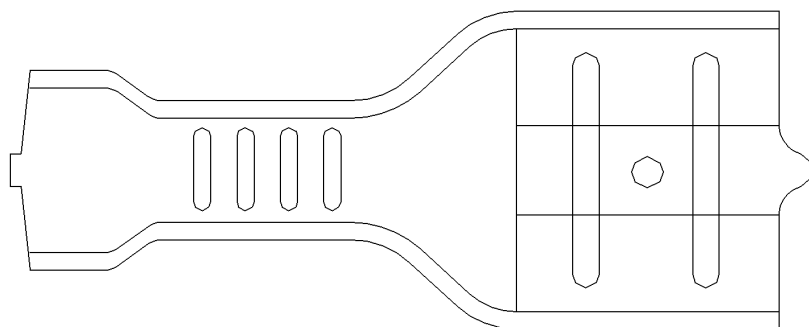

YPL10104

**(E)**

Interruptor de faros antiniebla  
 delanteros  
 Hembra  
 LATON  
 detrás de la parte central del  
 tablero

Cav	Col	Cct
1	UG	ALL